

---

# World Customs Journal

---

*September 2020*  
*Volume 14, Number 2*



WORLD CUSTOMS ORGANIZATION

**incu**  
INTERNATIONAL NETWORK OF CUSTOMS UNIVERSITIES

## *World Customs Journal*

Published by the Centre for Customs and Excise Studies (CCES), Charles Sturt University, Australia, and the Institute of Customs and International Trade Law (ICTL), University of Muenster, Germany, in association with the International Network of Customs Universities (INCU) and the World Customs Organization (WCO).

The *World Customs Journal* is a peer-reviewed journal that provides a forum for customs professionals, academics, industry researchers and research students to contribute items of interest and share research and experiences to enhance its readers' understanding of all aspects of the roles and responsibilities of Customs. The Journal is published twice a year. The website is at: <http://worldcustomsjournal.org>

Guidelines for Contributors are included at the end of each issue. More detailed guidance about style is available on the Journal's website.

Correspondence and all items submitted for publication should be sent in Microsoft Word or RTF, as email attachments, to the Editor-in-Chief: [editor@worldcustomsjournal.org](mailto:editor@worldcustomsjournal.org)

ISSN: 1834-6707 (Print) 1834-6715 (Online)

Volume 14, Number 2

Published September 2020

© 2020 CCES, Charles Sturt University, Australia and ICTL, University of Münster, Germany

INCU ([www.incu.org](http://www.incu.org)) is an international not-for-profit association that aims to raise the academic standing of the customs profession through the development and promotion of educational programs, providing academic and applied research, and intellectual input to strategic decision-making.

**Copyright.** All rights reserved. Permission to use the content of the *World Customs Journal* must be obtained from the copyright owner. Please apply to the Editor-in-Chief.

**Disclaimer.** The views expressed in the *World Customs Journal* are those of individual contributors and are not necessarily those of the Editorial Board, INCU, the WCO or its individual membership, or the publishers.

---

# Contents

Editorial.....	iii
<b>SECTION 1 – PAPERS TO BE PRESENTED AT PICARD 2020.....</b>	<b>1</b>
<b>If algorithms dream of Customs, do customs officials dream of algorithms? A manifesto for data mobilisation in Customs</b>	
<i>Kunio Mikuriya and Thomas Cantens.....</i>	<i>3</i>
<b>Why the future Revised Kyoto Convention should contain comprehensive rules of customs debt</b>	
<i>Hans-Michael Wolfgang, Achim Rogmann and Kerstin Harden .....</i>	<i>23</i>
<b>Implementing an innovation strategy in WCO; responding to disruptive events</b>	
<i>Ricardo Treviño Chapa .....</i>	<i>39</i>
<b>Managing customs risk and compliance: an integrated approach</b>	
<i>David Widdowson.....</i>	<i>63</i>
<b>Re-examining border clearance in the age of e-commerce</b>	
<i>Bryce C. Blegen.....</i>	<i>81</i>
<b>The WCO’s impact to date and lessons learned: the road from Columbus to Competency</b>	
<i>David Hesketh .....</i>	<i>99</i>
<b>The World Customs Organization as a knowledge-based organisation</b>	
<i>Jenia Peteva .....</i>	<i>109</i>
<b>Machine learning for detection of trade in strategic goods: an approach to support future customs enforcement and outreach</b>	
<i>Christopher Nelson .....</i>	<i>119</i>
<b>The changing role of Customs: Customs aligning with supply chain and information management</b>	
<i>Frank Heijmann, Yao-Hua Tan, Boriana Rukanova and Albert Veenstra.....</i>	<i>131</i>
<b>How can Customs better leverage emerging AI technologies for more sustainable and smarter operations?</b>	
<i>Ismael Kafando .....</i>	<i>143</i>
<b>World Customs Organization and global trade: imprints and future paradigms</b>	
<i>MM Parthiban, T Samaya Murali and G Kanaga Subramanian.....</i>	<i>157</i>
<b>Effectiveness and efficiency of artificial intelligence in boosting customs performance: a case study of RECTS at Uganda Customs administration</b>	
<i>Kugonza Julius and Mugalula Christabel.....</i>	<i>177</i>
<b>How to connect the PICARD program to regional capacity building activities—from the perspective of the WCO Asia Pacific Region</b>	
<i>Tong Hua .....</i>	<i>193</i>

**Customs capacity building through Partnership in Customs Academic Research and Development (PICARD): achievements and future directions.**

*Mikhail Kashubsky and Juha Hintsa*..... 197

**SECTION 2 – REFERENCE MATERIAL** ..... 225

Guidelines for Contributors ..... 227

Editorial Board..... 228

## Editorial



This special edition of the World Customs Journal has been prepared by the International Network of Customs Universities (INCUI) in partnership with the World Customs Organization (WCO). Its publication was originally designed to coincide with PICARD<sup>1</sup> 2020, which was due to take place this month in Jamaica. However, the world as we know it has changed dramatically during the course of this year, and as a consequence the PICARD conference, like so many other meetings, will now be held virtually.<sup>2</sup>

The primary focus of this special edition of the Journal is the WCO itself, in recognition of the significant role it plays in providing support to the international customs and trade community. Some contributors examine the WCO's impact to date, lessons learned, and the practical influence that the organisation and its instruments have on the performance of its member administrations, the international trading community and society as a whole. Others address the present role and future direction of the WCO, in recognition of the changing nature of borders and the way in which border management and the customs mission have evolved since the organisation's inception.

Globalisation and changing social expectations have led to the emergence of new and sometimes conflicting national, regional and international priorities in areas as diverse as trade facilitation, supply chain security and environmental sustainability. At the same time, the international trading environment itself has changed dramatically, and continues to do so in the wake of the information revolution and the uncertainty of future technological advances.

The diversity of articles presented in this edition of the Journal reflects the broad remit of the WCO, to whom its member administrations—with a collective responsibility for managing more than 98 per cent of world trade—look for leadership, guidance and support, particularly in uncertain times—such as a once-in-a-century pandemic!

The Editorial Board would like to thank the WCO for its support in producing this special edition, and we look forward to meeting and debating with our contributors and readers 'virtually' at PICARD 2020.

A handwritten signature in blue ink, which appears to read 'D. Widdowson'. The signature is fluid and cursive, with a large initial 'D' and 'W'.

Professor David Widdowson AM  
Editor-in-Chief

1 Partnership in Customs Academic Research and Development

2 PICARD 2020 will be held as a web conference from 23 to 26 November





## *Section 1*

*Papers to be  
presented at  
PICARD 2020*





# If algorithms dream of Customs, do customs officials dream of algorithms? A manifesto for data mobilisation in Customs

*Kunio Mikuriya and Thomas Cantens*

## Abstract

Governance by data is a growing global trend, supported by strong national public policies whose foundation is open data, artificial intelligence and decision-making supported by algorithms. Despite this trend and some technical advances, Customs face obstacles in deploying ambitious data use policies. This article describes these challenges through recent experience in some Customs administrations and considers the technical and ethical issues specific to all law enforcement agencies in the context of customs missions, to open paths for research and propose policy recommendations for a better use of customs data.<sup>1</sup>

## 1. Background

Big Data technologies—however we name them, ‘algorithms’, ‘artificial intelligence’ (AI), ‘machine learning’ (ML)<sup>2</sup>—are more than simple ‘tools’. They are a *daily gesture*, to travel, choose, exchange, but also police, control or punish.<sup>3</sup> Machines no longer help us to manufacture but to choose, in the sense of deciding, predicting or anticipating. As a counterpart of the ease with which machines can make choices with more celerity and accuracy than we do, there exists a worry that something is slipping out of our hands. Technologies seem to dictate our conduct to us, they evaluate our choices and guide us by calculations with results being imposed on us as mathematical evidence, and whereby proof is increasingly distant and obscure to non-specialists, therefore less and less disputable.

Technologies tend more and more towards the empowerment of the machine. What do algorithms dream of? With this provocative question, Denis Cardon (2015), a sociologist, refers to a double metaphor: the limitless extension of the presence of machines in our lives, but also the ambiguous relationship that we maintain with these machines that we would like to always perform better but which threaten to surpass us. Cathy O’Neil (2016), a mathematician, speaks of ‘weapons of Math destruction’ to denounce that algorithms are affected by numerous biases that accelerate and amplify social inequalities.

The power of states and their bureaucracies that make an increasing use of data and algorithms is added to that of the machines. Governance by data logically reinforces governance by numbers (Supiot, 2015)—the ‘quantophrenia’ of the state (de Gaulejac, 1990)—since the 1970s. Combined with AI, this governance raises concerns and criticisms, mainly about the emergence of a state of generalised surveillance. While these concerns are legitimate, they nevertheless demonstrate a limited vision of interactions between the state and society.

Tax administration and trade governance are still little explored areas of data science research. However, Customs were pioneers in IT, all over the world, from the 1970s for a few rich countries and the 1980s for the so-called developing countries. Today, despite technological disparities, all customs administrations

have automated some if not all of their procedures.<sup>4</sup> Customs administrations are often the first to be computerised among all tax administrations due to the fact that border processing is largely standardised worldwide. Customs collects data everywhere in a massive way. In addition to data, the computational culture is well established in Customs. For more than 20 years, most customs administrations have incorporated the concept of risk analysis either as a process in their IT systems or as a necessity to do so.

Most of the research on the use of customs data has been technical. Customs targeting and, more broadly, the fight against fraud have become classic problems for engineers, econometricians, statisticians and data scientists through their use of clustering, classification algorithms, econometric techniques, mirror analysis, and the search for outliers (Cantens, 2015; Cariole et al., 2019; Chermiti, 2019; Choi, 2019; Grigoriou, 2019; Hua et al., 2006; Laporte, 2011; Xiao et al., 2016; Yaquin & Yuming, 2010; Zhou, 2019). The use of data to reform or fight against bad practices, without necessarily mobilising complex algorithms, has also shown its effectiveness (Cantens et al., 2010; Chalendard et al., 2019; Grigoriou et al., 2019; Kalinzije, 2018). Researchers have quickly established links between customs issues and areas where AI is already very advanced, such as image recognition, applied to non-intrusive scanning inspections (Jaccard et al., 2017; Kolokytha et al., 2017). The World Customs Organization (WCO) BACUDA platform (BAnd of CUsToms Data Analysts) has developed a series of studies on the use of ML for Customs fraud detection, online price data collection, ML for customs revenue prediction, and data visualisation.<sup>5</sup> Finally, new possibilities are opening up with the customs use of geolocated data.

Examples drawn from the use of data science in tax administrations may also inspire customs officials: the detection of fraud schemes based on fiscal measures through the use of biological models of co-evolution (Hemberg et al., 2016), or the combination of ML and analysis networks for the selection of controls.<sup>6</sup>

This article analyses the spread of governance-by-data within Customs. It builds on these technical advances and multiple experiences, including a seminar on reform by numbers organised by the WCO and the World Bank in 2012, two expert workshops on data analysis in 2019, three high-level seminars organised by the WCO in different regions (Asia–Pacific, Europe and the Middle East and North Africa) in 2018 and 2019, a workshop on geospatial data organised at the WCO secretariat in 2019, various missions and visits to customs administrations, and a survey launched in 2019 with responses obtained from 60 customs administrations.

The first section examines how a new type of governance, a governance-by-data, is emerging, spurred by an increasing number of states. Most customs administrations have not yet integrated this evolution. The second section examines technical challenges that may explain this situation and suggests ways to tackle these challenges in the customs environment. The last section is focused on the role of Customs, that is at the interface of the economic and the repressive state, in the new relations of governance between states, businesses and citizens. It also explores policy conditions, under which Customs will adapt itself to this changing environment.

Two preliminary observations are necessary. First, these technologies are not reserved for a select few rich countries. In 2018, a World Bank symposium on the role of Big Data in achieving the Millennium Development Goals illustrated the diversity of data usage by governments.<sup>7</sup> More generally, data technologies usually leapfrog in less rich countries: they adopt the latest technologies, according to their needs, without following the linear pace of technology adoption in rich countries.

Second, data is associated with mining metaphors. It would be the ‘new oil’ (Humby, 2006) or the object of a new ‘gold rush’. These metaphors are even a part of the technical language, since we speak of ‘data mining’. They convey a reality: data, like crude oil or gold, has value only after treatments and for a multitude of usages. It is also true that data raised the same economic craze as oil and gold centuries

before. However, the mining metaphor is misleading: data is not scarce. If it is an economic resource, then it is the most widespread resource in the world, and the most egalitarian one since everyone produces and owns data (even if this property is often transferred to others).

These two points are essential for the global customs community: there are no rich and poor countries when it comes to data; there is no government or administration that could not embark on an ambitious policy to use data; there is no customs administration that would not have data, ‘big’ or not, to the extent of its needs.

## 2. Governance-by-data

Numbers with nearly exponential growth regularly account for the influence of technologies in contemporary societies. Computer science is populated with laws<sup>8</sup> and estimates that show a steady increase in the capacities of machines and the production of data.<sup>9</sup> The AI 2019 report (Crawford et al., 2019) estimates the performance of machines according to standard tests, and the machines’ progress is rapid: more precision (90% image recognition in 2019 compared to 60% in 2016) and more celerity (training of algorithms in 88s against 3h) (Crawford et al., 2019, from p. 48). This quantitative growth of data and machine capabilities reflects a deeper change, the emergence of governance-by-data (Elkin-Koren & Gal, 2019).

### 2.1. The emergence

The transition from governance by numbers to governance by data (and numbers) is made possible due to the fulfillment of four conditions.

The first condition is ‘the emergence of probability’ (Hacking, 1975) in the 17th century, a shift from deterministic thinking to probabilistic thinking, in science and governance. This epistemological change means that, in matters of governance, decisions are taken based on their probable quantifiable effects. The quantification of uncertainty is a major feature of contemporary thought and governance.

The second condition is the technological evolution of AI itself and the development of datacentric methods. In the 1950s, the ‘smart’ machine was centered on rules, designed to operate in complete information environments. A chess game has no unknown rules, all the information about the game can be supplied to the machine. It is only since the 1970s that AI has been applied to the real-world situations where knowledge of the rules is imperfect (Piscoppo & Birattari, 2008). For example, it is impossible to provide the machine with all the rules for recognising the subject of an image. A new step, more recently, confronts the machine with an actor who hides his action: this is the case of fraud detection. The environment is not only incomplete, it contains information purposefully hidden in data. This latest development is fuelling governance control and surveillance functions.

The third condition is the availability of data. By leaving the chess game and its rules, and by tackling fraud (for instance), the machine leaves the symbolic environments for real environments. This transition requires the provision of data in all areas (Brooks, 1991). As such, we should speak of a *Big Use of data*, rather than *Big Data*, to mean that the raw material of intelligence (artificial or not) is the data and no longer the rules.

The will to legitimise governance by reason, and reason by calculation, has therefore been combined with the scientific possibility of quantifying—and mastering—uncertainty, and with the fact that uncertainty is more reduced when there is more data available. The whole scheme works on the last condition that a machine is capable of carrying out calculations whose magnitude exceeds human capacities. This is the fourth and final condition: computer science, development of graphics processing units for calculation, decrease of data storage costs, cloud computing and cluster techniques have enabled researchers, businesses and administrations to mobilise significant computing and storage resources at

affordable cost.

Data governance is based on decision-making with uncertainty. It is not intended to ensure that something is true or not, but to classify solutions according to the degree of uncertainty of their effects. This principle is well known to customs officials who are obliged to choose a container or a shipment from among thousands. The principle is also at work in trade governance. Through international rankings on the ease of crossing borders, the logistical capacities of countries, borders are increasingly ‘mathematised’ in the sense of becoming data and calculation objects (Cantens, 2018).

### 2.2. Recent national AI and data strategies

Many states have adopted national AI and data strategies. Governments have set up more or less centralised open data<sup>10</sup> services, as in the United States,<sup>11</sup> France<sup>12</sup> and South Korea.<sup>13</sup> In 2011, the ‘partnership for open government’ was created as a multilateral entity bringing together 79 member states as of today (Open Government Partnership, 2019). The Organisation for Economic Co-operation and Development (OECD, n.d.) has developed the OURdata index (Openness, Usefulness and Re-usability), measuring the quantity of open data made available by states, its usefulness and ability to be used by third parties. In addition, states build directories of free software intended to constitute a common base for all their institutions.<sup>14</sup>

Regarding AI, since the 1950s, the relationship between states and machines has been less linear, marked by the famous two ‘winters’ of AI, in the 1960s and the late 1980s (House of Lords, 2018). Since 2017, state investment seems more massive. Around 50 states have developed strategic or normative documents relating to AI or ‘digital’ government (Schiff et al., 2020). Among these, around thirty have established a national strategy (Merz, 2019). In 2018, the British government released an AI Sector Deal (UK Government, 2018). In 2019, after having followed a liberal approach for a long time, leaving the role of innovation to the market, the American government launched its AI initiative, asking national agencies outside the defence sector to invest in AI to support the public demand (US Government, 2019).

A dozen strategies encourage the development of AI projects in public institutions. Some countries do not have a specific AI strategy but have integrated it into global policies to transform society through technology, such as Japan (Government of Japan, 2015). Most international or transnational organisations like the World Economic Forum also produce recommendations for states to support the industrial development of AI (World Economic Forum, 2019). Other international actors, such as the European Space Agency, invest heavily in AI.<sup>15</sup>

Some AI strategies are fuelled by substantial funding, more than USD 1 billion, in South Korea, France, Taiwan and the United Kingdom (Dutton et al., 2018). Some countries have created specific entities for AI. For example, the UK has its National Office for Artificial Intelligence (UK Government, n.d.); Niger launched a National Agency for the Information Society whose director has the rank of a minister;<sup>16</sup> France has a public data service, managed by a specific public body, Etalab.<sup>17</sup>

The national strategies are threefold: encouraging the emergence of an industrial sector for the use of AI by the private sector and public administrations; strengthening research capacities; and launching partnerships with the private sector (OECD, 2019). Among government initiatives, the idea of pooling state data led to creating governmental data trusts in India (NITI, 2018).

The origin of these initiatives is politically driven by the wish to generate a more ‘open’ government, sharing with citizens its results through indicators and data sets (House of Lords 2018, pp. 36–37; Jetzek et al., 2019). However, the idea of citizen participation in public life, through data, must be understood with caution: it is not ‘ordinary’ citizens who will be able to mobilise public data, but rather analysts (Dawes et al., 2016).

If the initial objective of political transparency is still valid, states recently recognised that data has become a national asset, in particular public services' data (US Government, 2020). States are encouraging the rise of the data-driven economy, in particular with the use of public services' data for industrial innovation (UK Government, n.d.).

AI and data have thus become a very strategic domain. They are 'dual-use goods' for states: a means of strengthening their governance capacity and a new dimension of the economy which they must support, in a global race for innovation, given the remaining uncertain profitability of this sector for many companies. States need also a robust and diversified AI and data industrial sector in order not to face a situation of a global economy dominated by a reduced number of transnational actors with data collection and analysis capacities that exceed that of states.<sup>18</sup>

### 2.3. Some customs applications

Security and fraud detection are the most used applications of data technologies in Customs, since the technologies had already been developed for the intelligence services, police and the military. The introduction to this paper has referred to research articles on the use of ML for fraud detection, but few are deployed operationally, and few administrations currently share their results.

Customs in Hong Kong, China, the Netherlands, Japan and Brazil recently reported to the WCO (2019) how they use data and AI for fraud detection. During the WCO workshops on data analytics and geospatial data, France, the United Kingdom, New Zealand, and South Korea also shared their experiences in the areas of fraud detection and risk analysis. The European border agency, Frontex, uses a geographic information system to manage the external borders of the European Union (EU), which fuses data from different sensors and sources (ships, individuals, other databases) (Malinowski, 2019). The EU has also launched the EU IBorderCtrl project, tested in three countries, to detect illegal migrants at border controls using facial expressions (EU, 2020).

Some areas are still under-explored, such as the use of AI to help taxpayers to be compliant: in Australia, a chatbot answers questions<sup>19</sup> of customers; and the same type of tool is deployed in the United Kingdom (UK Government, 2017).

The provision of customs open data varies greatly from one country to another: from a simple list of seaports in one country, to transaction-level data on penalties by Canada. Most customs administrations do not publish transaction-level data but rather aggregate data or public information in an electronically reusable format. While this information was already made public, the novelty is its availability in a single point.<sup>20</sup> It may look like a small step, but one should not underestimate both the difficulty for the administration to concentrate its data in one web portal, and the ease of access to information that this system brings to users and researchers.

There are cooperation initiatives between Customs and researchers that are largely based on the sharing of transaction-level data. In 2011, the United Kingdom customs launched a *datalab* to make its data accessible to researchers.<sup>21</sup> The data is 'de-identified': each importer and exporter is assigned a specific identifier.

Too few administrations use their data to analyse, or to simulate fiscal policies or antifraud strategies. The United States tax administration recently launched a call for expressions of interest to simulate large-scale tax policies, based on the simulation of citizens' lives, taking the reference of the video game 'Sims City'.<sup>22</sup> Wier (2020) worked with South African customs transaction data to identify the tax impact of fraud and its links to tax policies. Niger customs use transaction-level data to measure the fiscal and economic impact of customs measures before proposing them in the finance law. This type of

simulation also strengthens the capacity of Customs to defend their proposals during discussions with their governments or partners like the International Monetary Fund and the World Bank, who are large consumers of data.

There remains a need to promote a wider use of customs data at a global level (Okazaki, 2018; Polner, 2018). No administration has yet appeared as data-driven or developed a comprehensive data policy. Two obstacles are common to all administrations.

The first is *scalability*, moving from a ‘pilot’ project on algorithms developed in a lab, to integrating the algorithms into an existing customs architecture. This industrialisation of research outcomes is often complex and must take into account many parameters, one of them being the existing customs IT system. In rich countries, there is a gap between the technologies underlying existing customs IT systems and the technologies used in data science for less than a decade.

The second obstacle is *profitability*, in particular for administrations responsible for generating public revenues. In the light of the sometimes boundless enthusiasm for AI and Big Data, we are all tempted to question the reality of high-tech projects. Are they profitable? Should we get into Big Data by crossing customs data with data available on the internet? The answer is positive for certain uses such as finding the value of goods through e-commerce sites. For offences involving prohibited or restricted products, real traffickers mostly do not openly stage themselves on social networks. Deploying AI to catch a passenger returning from a trip with more cigarettes than the maximum allowed is certainly not profitable. In addition, as a customs official recognised, before deploying AI to open data, customs data itself should already be fully mastered.

National AI and data strategies are broad, they are evidence that states are aware of the value of data. Their implementation in Customs, beyond the pilot projects, remains to be seen. There is, however, an emergency. The ‘adversaries’ of Customs may also use AI. A ‘legal tech’ is already being developed to help taxpayers in their litigation procedures: AI assists in predicting a probable outcome of the litigation; ‘e-discovery’ is used to automatically read large quantities of documents and select the most relevant ones (Deloitte, 2018; Engstrom & Gelbach, 2020; Klutz & Mulligan, 2019). There is no technical obstacle that prevents an importer from using customs data—if he illegally purchases it from a customs IT department—or his own operational data, to ‘optimise’ the gain of a fraud given the way he completes his declaration.

Given the enthusiasm around the use of data, the possibilities offered by AI, and massive investments that are underway or planned by governments, Customs will ‘do’ governance-by-data. The uncertainty related to the best conditions under which they will be involved in this evolution. These conditions, technical and political, are discussed in the next two sections.

### **3. Bias, interpretability: technical challenges common to law enforcement agencies**

As in any evolution, technologies raise questions about their integration into existing practices. Some of these questions are technical and well known: bias and interpretation of algorithm results. This section contextualises them in the customs environment, before proposing some research paths to overcome them.

#### **3.1 Bias**

Both technical and ethics literature are rich in studies on bias in algorithms (Dobbe et al., 2018), the amplification of biases (Lum & Isaac, 2016), and the near impossibility of preventing bias in the construction of some algorithms (Mittelstadt et al., 2016). It is the famous ‘garbage in, garbage out’ in statistics (Geiger et al., 2020) that is amplified by ML, or the ‘dirty data’ in the police, designating racist

or ethnic biases (Richardson et al. 2019a), or the pressure of performance indicators which incentivise supervisors to over-report or omit certain data.

In Customs, a cause of bias can be data that is poorly collected (a lack of difference between ‘origin’ and ‘provenance’ for example, or between the importer and the final owner, which will make some origins or importers invisible in the dataset) or data that is incomplete (information on the point of entry into the territory is not available for all offices and the state capital is mentioned instead of a concrete border post or a geographical location). Another example is that corruption can bias the data: certain fraudsters or kinds of fraud may never appear as such in data that is used to train the machine, or wrong values may be regularly accepted by Customs and will therefore be considered as regular by the machine.

The machine is neither racist nor corrupt, that is a definite but non-sufficient advantage. It is difficult if not impossible to separate ‘good’ data from biased data (Richardson et al., 2019b). Conversely, it is impossible to postulate an absence of bias. This is the ‘there is no free lunch’ theorem: you need prior knowledge that makes the learning conclusions relevant or not (Shalev-Shwartz & Ben-David, 2014).

If bias is unavoidable, it is not a fatality. For instance, predictive policing software includes ‘forgetting’ past data to regularly renew the samples (Shapiro, 2019). It may also add an element of uncertainty via randomisation, and by producing only one indication, ‘a place is at risk’ (without specifying either the degree of risk or if this risk is attributed by the randomisation process). By doing so, predictive policing software gives some room for action and initiative to police patrols and includes reporting tools to analyse police tactics in the field, their over-control of certain populations and their effectiveness. It is close to the logic of ‘performance contracts’ tested in Customs against corruption that only control the use of their discretionary powers by customs officers through transaction-level data analysis (Cantens et al., 2014).

### 3.2 Interpretability

To better understand the challenges of interpretability in Customs, here is a simple example. To predict whether a customs declaration is at risk, the traditional techniques were based on econometrics: we hypothesised on fraud factors, evaluated their importance within an econometric model, and calculated the risk associated with each new declaration. This approach was based on the modelling of the fraud factors that we considered fair and mathematically tested and verified. Today, these techniques are still used, but others have emerged, such as deep learning and neural networks, which can predict the probability of fraud of a declaration. However, with these new techniques, we are not always able to know how the machine comes to the result. The designers of the algorithm could explain its mechanisms, but they themselves could not reconstruct the ‘intellectual’ thread that led the machine to the result. They wouldn’t be able to do so because ... there’s no more thread. This type of technique is used by the European experimental system iBorderCtrl, which processes facial movements to detect impostors at borders (Crockett et al., 2018).

The interpretability of an algorithm is a parameter that sometimes comes into play when, from a range of algorithms, we have to choose the one that seems most appropriate. This is why decision trees are often adopted in Customs. As a reminder, the use of decision trees is a learning technique that optimises the combination of customs declaration fields to calculate risks of fraud. At each level of the tree, we check that the declaration meets a criterion and we thus go to the final ‘leaves’, which give us the probability of fraud. These algorithms therefore return us a readable result, as a combination of declaration fields and values, which we can simply translate into computer rules in the customs clearance system.

The way in which an algorithm achieves a result is not just a theoretical or technical question, it is also legal one. According to the European Union regulation 2016/679,<sup>23</sup> people must have access to the logic behind the automated processing, the data provided must be ‘readable’, which prohibits proprietary formats, and automated processing alone cannot form the basis of a decision. Profiling for tax purposes is

excluded from these constraints, but in all cases it will be necessary either to explain the basis on which the decision of the machine was made, or to advance arguments that are not drawn from the results of the machine.

Wachter et al. (2018) have shown the limits to the right of explanation in European Union regulations: it is limited to some cases, and the explanations may be too light or obscure. To justify that bias does not influence decisions, a solution advanced by Wachter et al. (2018) is to produce counterfactuals: render the decision for the existing situation A, but also provide a different decision that would have been made in a hypothetical situation B so that the user understands how the decision was made.

Finally, we should not over-interpret the machine's outcome: the machine does not predict customs fraud any more than it predicts crime for police. Predictive police software only predicts the crimes' possible locations (Ensign et al., 2017). Similarly, at Customs, it is by a semantic shift that we say that it predicts fraud. The machine is not trained on fraudulent declarations, it is trained on detected fraudulent declarations.

### 3.3 Inability to assess the extent of errors

In addition to the opacity of the algorithms, the machine is unable to evaluate its errors other than quantitatively.

One can imagine two algorithms for customs targeting. The first one detects commercial fraud with a better probability than the second one, but the false negatives (fraudulent declarations but not selected by the algorithm) of the first one are essentially illegal imports of weapons, while the false negatives of the second one are more diverse. Which algorithm to choose? Probably the second one even if it makes more mistakes, as they are less serious than those of the first one.

Any probability leads to a margin of error, but the algorithms remain incapable of anticipating the severity of the consequences of their errors.

This raises legal questions about human responsibility (Elish, 2019): who is responsible when the machine makes a mistake? How to estimate the degree of responsibility when the human in contact with the machine has only minimal control over it, and sometimes little knowledge of its functioning? These questions have crucial consequences in countries that severely punish corruption or loss of public revenue due to bad practices or officials' errors. In these countries, customs officials are already reluctant to rely on risk analysis systems because they fear being punished if undetected fraud leads to tax losses. The use of machines to fight fraud will lead to changes in the law regarding human responsibility.

### 3.4 Problem of the ML methodology applied in Customs

ML is probably the most modest and pragmatic approach to AI: it does not seek to imitate human intelligence or build a so-called 'strong' artificial intelligence. We must dwell a little on the methodological aspects. What do we do when we try to prove that the ML algorithm is good? Very broadly presented, a sample of declarations is split in two. All these are processed declarations, so we humans know which ones are fraudulent and which are not. With the first part of the sample, we train the machine to 'understand' what fraud is. With the second part, we test our trained machine to detect fraud. The result of the test is that we have four categories of declarations: 'true positives' ('true negatives') being fraudulent (non-fraudulent) declarations found as such by the machine, 'false positives', being non-fraudulent declarations considered as fraudulent by the machine, and 'false negatives' being fraudulent declarations considered as non-fraudulent by the machine. The algorithm is considered as 'good' if it detects a high rate of fraudulent declarations while directing in circuit control less declarations than the human.



It is necessary, here, to take note of customs specificity. In police, an offence can be declared and documented by victims, and not as a follow-up of a police intervention. Data on offences is therefore closer to the reality, while in Customs, there is no more data on fraud than the fraud discovered by customs officials (on the spot and *a posteriori*).

This raises a methodological problem, particularly related to convincing customs officials to use ML. In police, the outcomes of an algorithm ‘predicting’ offences can be compared to the police action, and it can be shown that the algorithm is performing ‘better’ than the police. This is not the case with current customs methods: the machines will only detect ‘almost as much’ fraud as customs officials because the detection method is based on discovered cases by customs officials. This problem is linked to the validation methods used for algorithms and has policy effects: how to convince customs officers to use a machine that detects less than them?

As in other domains, customs officials will be more capable than machines to face unpredictable situations. However, in Customs, it is, for now, the addition of two assertions— detecting almost as much and, above all, controlling less—that makes sense. This ‘control less’ corresponds well to the political doctrine of trade facilitation and the reduction of controls, but it will always come up against the *ethos* of the customs officer who wants to find more fraud and not find almost as much.

### 3.5 Some technical research paths

New experimental plans, particularly in ML, could improve the efficiency of the machine and its adoption by customs officials. These plans could carry out fully automated control periods versus completely non-automated periods, at random, a sort of randomly controlled trial. One can also imagine setting up an experimental plan on the *ex post* controls, on a sample of declarations which would all have been checked beforehand.

The algorithms themselves could offer experimental testing techniques: one must be able to test a control or patrol strategy against another or the current one. The machine should be able to help us predict the effects of an anti-fraud strategy before it is implemented. The aim is to relax the automaticity of the machine and recreate the conditions of choice for the officials.

We can also add a bit of chance. Randomisation is an important technique described in the police environment to make repressive actions less predictable by fraudsters and reduce bias (Shapiro, 2019). From a technical point of view, the interest of adding some randomisation in risk profiling is also to increase our knowledge of fraud. This echoes the customs officer’s flair. However, the problem becomes technical again. What do we define as ‘flair’, how can the machine reach it? The introduction of randomisation is a human decision and its amount should comply with a criterion of acceptability of control, a maximum inspection rate for example, rather than follow a scientific, calculated criterion of optimisation. How could the machine decide in what proportion it increases its rate of randomised controls, which would be a quantitatively blind decision? How to program the machine for a choice between a blind chance and quantification of the error, which goes against its *raison d’être*?

Solving the previous technical questions—bias, interpretability, the ability to assess the impact of an error, the way to evaluate an algorithm—will increase our trust in machines. However, this technical trust is not the most complex to achieve. Customs administrations should also address more policy-oriented questions.

## 4. What is the place for Customs in the new data ecosystems?

Customs is a part of ‘data ecosystems’<sup>24</sup> comprising citizens, who are both subjects of law and more or less voluntary producers of data about themselves, administrations, and transnational companies that have the capacity to collect data that is comparable to that of the states. The place of customs administrations in such ecosystems depends on the way they address three questions specific to law enforcement agencies and adapt them to the context of tax and trade governance: (i) the ethical dilemma between control and ‘privacy’, or ‘commercial secrecy’ in the case of Customs; (ii) the value given to the equality before the tax law, which is specific to customs and tax administrations; and (iii) the consolidation of public administrations’ position in environments based on innovation.

### 4.1 Surveillance and ethics

Within these ecosystems, state surveillance through algorithms is a growing concern for citizens (Crawford et al., 2019; Burrell, 2016; Lyon, 2014). Law enforcement and intelligence services are on the front line, but Customs are also concerned, for example through the Advance Passenger Information/ Passenger Name Record rules or the monitoring of social networks and online commercial websites. Part of the distrust comes from the fact that civil administrations often transplant tools initially developed in the military or intelligence domains (Brayne, 2017; see for instance Palantir products). This is the case with intelligence data collection and fusion tools,<sup>25</sup> but also with the ongoing ‘democratisation’ of geospatial analysis and satellite imagery.

Data technologies are therefore not that ‘disruptive’. They are a part of the continuous increase of the asymmetry of force and power between states and citizens, which has existed since the birth of states and the development of weapons and policing techniques.

However, three facts are new, transforming this simple asymmetry between states and citizens into ecosystems where relationships are more interdependent.

On the one hand, private companies are building surveillance capacities equivalent to those of states. Transnational companies follow the same logic as the intelligence services: to collect as much data as possible on their customers, without necessarily knowing *a priori* the specific objectives for which the data will be used. In addition to storing data on individual consumption, publicly expressed opinions, contact networks and movements, some of these companies also offer data hosting, calculation capacities and professional application services in the ‘cloud’. They are building surveillance platforms for economic purposes (Zuboff, 2015; Manohka, 2018), with the paradox that they are ultimately less controlled than the administrations themselves (Loo, 2019).

On the other hand, the fuel for surveillance—data—is produced by the people themselves. The concept of an ecosystem is relevant: to exercise their control, administrations will increasingly depend on data voluntarily produced by the citizens themselves.

Finally, states do not directly ask citizens to further cooperate in providing information. There is a growing integration of private and public data systems for security and surveillance purposes. There are, for example, private camera systems with facial recognition sold by large companies and offered to be connected to police departments (Haselton, 2019). In addition, public institutions collect individual data posted by social media companies,<sup>26</sup> and companies are increasingly encouraged to collect and share data with the state (Elkin-Koren & Gal, 2019).

Customs may be very tempted to develop ‘soft’ control: an extensive use of data, including that stored by companies, to impose less heavy control on those who are controlled, but at the expense of more secrecy, more intermediaries in the chain of control, and less control of the controllers.

In addition, we should already consider the medium-term consequences of a systemic data sharing between public institutions and private companies. It might cause growing mistrust on the part of users who could refuse to provide their data, or even worse, provide fake data.<sup>27</sup> As the exchange of data between government and businesses grows, citizens' trust is likely to decrease, the quality of the data may deteriorate, and the data collected by the private sector may become irrelevant for all actors for surveillance purposes, but also for innovation, which is another use of data by the private sector (Elkin-Koren & Gal, 2019).

Ethical issues related to AI are very present in the mainstream media, but, in AI conferences, ethics represents ultimately a very small share of the communications (Crawford et al., 2019, from p. 45). Within national strategy documents, ethical issues often feature prominently, which does not mean that concrete decisions are taken at the level of the administrations. These ethical issues are barely discussed in customs administrations, which stick to existing general legal limits but do not set up specific bodies to control and envision the ethical consequences of the use of data technologies.

In the absence of a joint effort on ethics, the risk is twofold at the global level. First, the extensive use of data by Customs may generate new legal obstacles to exchange information between customs administrations. Second, there may be a proliferation of national principles and standards, which would allow private companies to adopt market strategies, choosing the countries where the rules are not an obstacle to their uses of AI and data (Floridi & Cowls, 2019). Customs and tax administrations are already aware of this shopping strategy with tax regulations.

## **4.2 The value of equality before the tax law**

What is in balance with surveillance is the security of citizens, following a disputed and widespread rationale according to which 'more security implies more surveillance and more data'. One point is rarely put forward: the balance between surveillance and equality, especially equality before the tax law.

For example, in technical terms, this would mean ensuring that the machine does not deploy a discriminatory control strategy: the machine may assess that it is more profitable to systematise control over small importers than large ones, because the former are subject to more errors giving rise to minor sanctions. However, when detected in large numbers, these minor sanctions would generate more extra-revenue than the litigations on large importers whereby outcomes are more uncertain because investigations are more complex.

When the 2020 finance law authorised the French customs and tax administrations to automatically collect data on social networks, the body responsible for ensuring compliance with the French Constitution recognised that it was a violation of the right to privacy but that equality before the tax law was also a cardinal value of society and that, provided certain technical safeguards were in place, the equality before the tax law should prevail.

Citizen security is a state function, associated with a monopoly on violence, but taxation is another state monopoly and it is based on equality of citizens before tax. Although the balance between surveillance and security can be assessed at the individual level—'to what extent am I ready to be monitored more to be more secure?'—the balance between surveillance and taxation is more complex, for it is based on a collective assessment, as the tax is above all a relationship between the individual and society.

Customs should therefore not line up behind the police in the surveillance and security debate. Customs and tax administrations are bringing new fundamental questions: the balance between privacy and tax equality at the time when individual assets are extremely complex to assess by administrations (Cantens, 2018).

### 4.3 Customs responses for an innovative place in the new ecosystems

The first response is to share customs data with the outside world. It is more legitimate for states to request and collect data when they also release data themselves. The HMRC (Her Majesty's Revenue & Customs) 'lab' thus offers researchers an opportunity to access individual and transaction-level data under strict security conditions (de-identified data, secure room, no internet connection, checks of data extractions) (Almunia et al., 2019). Another option is to generate a sample of importers/exporters that is statistically representative of the population of economic actors and build a shareable and annually updated dataset (Burdick et al., 2019). Customs data, at the transaction level, has a very important value for commercial interests and economic policies.

Transaction-level data is important at the local level too. At the border, Customs can become a 'data hub' for all stakeholders since Customs centralise the data of logistics actors, brokers, importers and exporters. The administration can also play the role of an objective 'evaluator', quantifying the dysfunctions caused by all actors including Customs.

A second response is the connection to the community of programmers. Several American administrations have put their algorithms online, free of charge, notably in relation to passenger control. In December 2017, the US Department of Homeland Security offered financial prizes in the Passenger Screening Algorithm Challenge to improve the accuracy of algorithms that detect threats at the airports (Kaggle, 2017). Datasets have been made available to programmers for this challenge. In 2019, another challenge was launched to detect an actual exporter in customs documents (Burdick et al., 2019). Finally, in 2020, the WCO research unit, in cooperation with Korean academics, shared a risk analysis algorithm with the data science community (Sundong et al., in press). This transparency sometimes leads to co-development of governance. In the case of a health administration, an American citizen demonstrated that the administration's chosen algorithm was less efficient than his own.

The third response is the use and promotion of open source software. Open source software does not necessarily cost less when it comes to scaling up an algorithm in the IT customs system. The advantage is communicability. By adopting free tools of contemporary data science, Customs become part of global user communities, benefitting from solutions and scientific updates, and are not locked into proprietary systems. In addition to the possibility of exchanging more simply between customs administrations, the use of open source software fosters trust in general and increases the possibility for an administration to communicate details of its tools, including during litigations. As national key players in the fields of taxation, trade and security, Customs can play a leading role by pushing governments to adopt data science open source software as an administrative standard.

The fourth response is a human resources policy, which increases data literacy in general and dedicates resources to the training of customs officers. The worst-case scenario would be high-tech companies selling products to administrations with no technological culture that are only concerned with the perfection of enforcing the law. The increasing use of algorithms in the police and justice systems has resulted in a fear of deskilling among police, prosecutors and judges (Brayne & Christin, 2020).

The United Kingdom has created a campus managed by the Office of National Statistics and universities, proposing curricula in data science and public administration applications.<sup>28</sup> Distance learning courses are open to civil servants, thus forging a common culture. These courses are also open to the public, which is an opportunity for administrations to recruit graduates who will have been trained on public administration issues. South Korean Customs has implemented a long, joint training course for customs officials on data science tools, led by academics. These two initiatives among others are a part of the philosophy of data: what matters initially is not so much the mastery of a computer language or statistical technique, but the 'domain knowledge', the familiarity with the data. In all customs administrations, there are computer specialists, engineers, statisticians, investigators, front-line inspectors who gradually acquire 'practical knowledge', an empirical and intuitive intimacy with the data on which they work

daily. One has to be able to ‘walk’ through the data as one would walk in a landscape and look for order, trends, and anomalies. It is a common saying that eighty per cent of the time of the data analysis cycle is spent preparing and cleaning the data, but this is not wasted time, it is the time needed to be put *into* the data.

Training is not sufficient; the administrations must retain talented staff. The situation is similar to that which we experienced more than 20 years ago during the advent of the internet. It was difficult to recruit specialists in new communication technologies. Some customs administrations overcame this difficulty by offering a meaningful working environment for young graduates, in particular by offering them good infrastructure and complex technical challenges. For many data scientists, it will be motivating to work on issues related to the protection of society.

## 5. Conclusion and some policy recommendations

The incredible ambition of Big Data is the idea that we could make a decision based on a perfect argument, because we would have all the data relating to the problem. However, when achieving this stage of perfection, we must delegate the freedom to work on this data to machines. These new paradigms of science and governance generate new ‘data ecosystems’. Regardless of the terminology, technological developments have resulted in an increasingly close interweaving among states, citizens, and companies handling data on a global scale.

Today, the most advanced customs administrations have deployed techniques based on data analytics; nevertheless, none embraces, either strategically or technically, a wide range of the possibilities offered by data and data science. In addition, most customs administrations will find it difficult to explore alone expensive technologies that may not provide immediate results. This conclusion outlines some ideas that the rapid evolution of the data ecosystems should not make obsolete in the short term:

1. keeping a wide scope. More areas than only fraud deserve exploration and projects: revenue forecasting, border security based on geodata, optimisation of patrols in the field, topology of customs units according to trade routes, economic projections, performance measurement including fight against corruption;
2. working together at the global level to make data technology contribute to the strengthening of the customs community. Some projects could animate the community: produce common standard datasets to be used to assess the performance of algorithms, share algorithms and models to promote peer review among customs experts;
3. developing know-how on exploratory data analysis. Too many experts are immediately curious to apply ‘models’, while it is not the philosophy of the new data-centric approaches. Data comes first, it is necessary to develop, among specialists, the taste and the capacity to ‘walk in the data’; and
4. favouring free tools of data science and their appropriation for customs purposes. Proprietary software or commercial off-the-shelf software are designed at a given time and are state-of-the-art regarding the problems the administration wants to treat. Their format and functions force analysts to adopt particular thinking patterns. A maximum of freedom and flexibility should be given to analysts to create their own toolbox. With this in mind, some basic open software and languages are better than commercial software.

Looking back over the past years, we can be optimistic. When the WCO put mathematics on the PICARD conference agenda in 2015, to say that the participants expressed little enthusiasm would be an understatement. Five years later, in 2020, the Secretariat has launched a cloud computing platform with BACUDA, paving the way to explore the possibilities offered by data while maintaining an experimental approach. By developing its data literacy, the customs community brings new questions to the public

debate, such as the equality before the tax law, and supports innovative approaches to elaborate and assess public policies in fiscal and trade governance.

We do not need to dream of algorithms; they are already here. New ‘autumns’ for AI may come to be, but new winters are unlikely, particularly for data, since we cannot help producing data. The final words are, therefore, for those who still mistrust the emergence of governance-by-data. In societies where machines are *de facto* more involved in public administration, data may be our best collective safeguard. Machines are no more than fuelled by the data we all produce, be it administrations’, companies’ or individuals’ data. The same data can be mobilised to combat political arbitrariness and inequalities. As we all produce data, isn’t governing by data an opportunity to forge more transparent and collective policymaking, taking into account all data, therefore everyone’s data?

## References

- Almunia, M., Harju, J., Kotakorpi, K., Tukiainen, J., & Verho, J. (2019). Expanding access to administrative data: the case of tax authorities in Finland and the UK. *International Tax and Public Finance*, 26(3), 661–676.
- Andrews, L. (2019). Public administration, public leadership and the construction of public value in the age of the algorithm and ‘big data’. *Public Administration*, 97(2), 296–310.
- Brayne, S. (2017). Big data surveillance: The case of policing. *American Sociological Review*, 82(5), 977–1008.
- Brayne, S., & Christin, A. (2020). Technologies of crime prediction: The reception of algorithms in policing and criminal courts. *Social Problems* spaa004. <https://doi.org/10.1093/socpro/spaa004>.
- Brooks, R. (1991). Intelligence without reason. In *Proceedings of IJCAI’91*. <https://www.ijcai.org/Proceedings/91-1/Papers/089.pdf>
- Burdick, D., Krishnamurthy, R., & Raschid, L. (2019). DSMM’19: The 5th workshop on data science for macro-modeling with financial and economic datasets. *Proceedings of the 2019 International Conference on Management of Data* (pp. 2068–2069).
- Burrell, J. (2016). How the machine ‘thinks’: Understanding opacity in machine learning algorithms. *Big Data & Society*, 3(1), 1–12. <https://doi.org/10.1177%2F2053951715622512>
- Cadwalladr, C., & Graham-Harrison, E. (2018, March 17). Revealed: 50 million Facebook profiles harvested for Cambridge Analytica in major data breach. *The Guardian*. <https://www.theguardian.com/news/2018/mar/17/cambridge-analytica-facebook-influence-us-election>
- Canella, G. (2018). Racialized surveillance: Activist media and the policing of black bodies. *Communication Culture & Critique*, 11(3), 378–398.
- Cantens, T. (2015). Mirror analysis: Customs risk analysis and fraud detection. *Global Trade & Customs Journal*, 10, 207.
- Cantens, T. (2017). The Political Arithmetic of Borders: Towards an Enlightened Form of Criticism. *The AntiAtlas Journal*, 2017, No. 2.
- Cantens, T. (2018). Of taxation, instability, fraud and calculation. *Economy, Crime and Wrong in a Neoliberal Era*, 36, 116.
- Cantens, T., Ireland, R., & Revesz, P. (2014). *The why and how of performance measurement contracts*. World Customs Organization. [http://www.wcoomd.org/-/media/wco/public/global/pdf/topics/research/guide/wco\\_pmc-guide.pdf](http://www.wcoomd.org/-/media/wco/public/global/pdf/topics/research/guide/wco_pmc-guide.pdf)
- Cantens, T., Raballand, G., & Bilangna, S. (2010). Reforming Customs by measuring performance: a Cameroon case study. *World Customs Journal*, 4(2), 55-74.

- Cardon, D. (2015). A quoi rêvent les algorithmes. Nos vies à l'heure: Nos vies à l'heure des ... – Dominique Cardon – Google Livres. Editions du Seuil.
- Cariolle, J., Chalendard, C., Geourjon, A.-M., & Laporte, B. (2019). Measuring and improving the performance of customs valuation controls: An illustration with Gabon. *The World Economy*, 42(6), 1850–1872.
- Chalendard, C., Raballand, G., & Rakotoarisoa, A. (2019). The use of detailed statistical data in customs reforms: The case of Madagascar. *Development Policy Review*, 37(4), 546–563.
- Chermiti, B. (2019). Establishing risk and targeting profiles using data mining: Decision trees. *World Customs Journal*, 13(2), 39–58.
- Chesnais, J.-C. (1995). Nicholas Eberstadt. The tyranny of numbers. Mismeasurement and misrule. *Politique étrangère*, 60(4), 1059–1060.
- Chesterman, S. (2008). We can't spy... if we can't buy!': The privatization of intelligence and the limits of outsourcing 'inherently governmental functions'. *European Journal of International Law*, 19(5), 1055–1074.
- Chesterman, S. (2019). Artificial intelligence and the problem of autonomy. *Notre Dame Journal on Emerging Technologies*, 1, 220–250.
- Choi, Y. (2019). Identifying trade mis-invoicing through customs data analysis. *World Customs Journal*, 13(2), 59–76.
- Crawford, K., Dobbe, R., Dryer, T., Fried, G., Green, B., Kaziunas, E. . . Whittaker, M. (2019). *AI Now 2019 report*. AI Now Institute, New York University.
- Crockett, K., Stoklas, J., O'Shea, J., Krügel, T., & Khan, W. (2018). Adapted psychological profiling verses the right to an explainable decision. *IJCCI 2018 – Proceedings of the 10th International Joint Conference on Computational Intelligence* (p. 14). SCITEPRESS.
- Dawes, S., Vidasova, L., & Parkhimovich, O. (2016). Planning and designing open government data programs: An ecosystem approach. *Government Information Quarterly*, 33(1), 15–27.
- de Gaulejac, V. (1990). De la mesure en tout! Evaluation et développement social. *Les Annales de la Recherche Urbaine*. 47, pp. 117–122. Centre de Recherche d'Urbanisme.
- Deloitte. (2018). *16 artificial intelligence projects from Deloitte: Practical cases of applied AI*. <https://www2.deloitte.com/content/dam/Deloitte/nl/Documents/innovatie/deloitte-nl-innovatie-artificial-intelligence-16-practical-cases.pdf>
- Devins, C., Felin, T., Kauffman, S., & Koppl, R. (2017). The law and big data. *Cornell JL & Public Policy*, 27, 357.
- Didimo, W., Grilli, L., Liotta, G., Menconi, L., Montecchiani, F., & Pagliuca, D. (2020). Combining network visualization and data mining for tax risk assessment. *IEEE Access*, 8, 16073–16086.
- Dobbe, R., Dean, S., Gilbert, T., & Kohli, N. (2018). A broader view on bias in automated decision-making: Reflecting on epistemology and dynamics. *arXiv preprint arXiv:1807.00553*.
- Dutton, T., Barron, B., & Boskovic, G. (2018). *Building an IA world: Report on national and regional AI strategies*. CIFAR. [https://www.cifar.ca/docs/default-source/ai-society/buildinganaiworld\\_eng.pdf?sfvrsn=fb18d129\\_4](https://www.cifar.ca/docs/default-source/ai-society/buildinganaiworld_eng.pdf?sfvrsn=fb18d129_4)
- Elish, M. C. (2019). Moral crumple zones: Cautionary tales in human-robot interaction. *Engaging Science, Technology, and Society*, 5, 40–60.
- Elkin-Koren, N., & Gal, M. (2019). The chilling of governance-by-data on data markets. *University of Chicago Law Review*, 86, 403–431.
- Engstrom, D., & Gelbach, J. (2020). Legal tech, civil procedure, and the future of adversarialism. *University of Pennsylvania Law Review*. Forthcoming.

- Ensign, D., Friedler, S., Neville, S., Scheidegger, C., & Venkatasubramanian, S. (2017). Runaway feedback loops in predictive policing. *arXiv preprint arXiv:1706.09847*.
- European Commission (EC). (2018, July 18). *Antitrust: Commission fines Google €4.34 billion for illegal practices regarding Android mobile devices to strengthen dominance of Google's search engine*. Press release. [https://ec.europa.eu/commission/presscorner/detail/en/IP\\_18\\_4581](https://ec.europa.eu/commission/presscorner/detail/en/IP_18_4581)
- European Union (EU). (2020). *iBorderCtrl. The project*. <https://www.iborderctrl.eu/The-project>
- Floridi, L., & Cows, J. (2019). A unified framework of five principles for AI in society. *Harvard Data Science Review*, 1(1). <https://doi.org/10.1162/99608f92.8cd550d1>
- Geiger, R., Yu, K., Yang, Y., Dai, M., Qiu, J., Tang, R., & Huang, J. (2020). Garbage in, garbage out? Do machine learning application papers in social computing report where human-labeled training data comes from? *Fairness, Accountability and Transparency*. ACM.
- Government of Japan. (n.d.). *Society 5.0*. [https://www8.cao.go.jp/cstp/english/society5\\_0/index.html](https://www8.cao.go.jp/cstp/english/society5_0/index.html)
- Government of Japan. (2015). *5th Science and Technology Basic Plan - Society 5.0*
- Grigoriou, C. (2019). Revenue maximisation versus trade facilitation: the contribution of automated risk management. *World Customs Journal*, 13(2), 77–90.
- Grigoriou, C., Kalizinje, F., & Raballand, G. (2019). How helpful are mirror statistics for Customs reform? Lessons from a decade of operational use. *World Customs Journal*, 13(2), 105–114.
- Hacking, I. (1975). *The emergence of probability: A philosophical study of early ideas about probability, induction and statistical inference*. Cambridge University Press.
- Haselton, T. (2019, August 3). Everyone's talking about this Amazon app that lets police see camera footage – here's what it's like. *CNBC*. <https://www.cnn.com/2019/08/02/amazon-ring-neighbors-app-sends-video-to-police-departments.html>
- Hemberg, E., Rosen, J., Warner, G., Wijesinghe, S., & O'Reilly, U.-M. (2016). Detecting tax evasion: A co-evolutionary approach. *Artificial Intelligence and Law*, 24(2), 149–182.
- House of Lords. (2018). *AI in the UK: ready, willing and able?* Select Committee on Artificial Intelligence, Report of Session 2017–2019. <https://publications.parliament.uk/pa/ld201719/ldselect/ldai/100/100.pdf>
- Hsu, K.-W., Pathak, N., Srivastava, J., Tschida, G., & Bjorklund, E. (2015). Data mining based tax audit selection: A case study of a pilot project at the minnesota department of revenue. In K.-W. Hsu, N. Pathak, J. Srivastava, G. Tschida, & E. Bjorklund (Eds.), *Real world data mining applications*, (pp. 221–245). Springer.
- Hua, Z., Li, S., & Tao, Z. (2006). A rule-based risk decision-making approach and its application in China's customs inspection decision. *Journal of the Operational Research Society*, 57(11), 1313–1322.
- Humby, C. (2006). Data is the new oil. *Proceedings of the ANA Senior Marketer's Summit*. Evanston, IL, USA.
- ITU News. (2019, January 10). Smart villages: Empowering rural communities in 'Niger 2.0'. *ITU News*. <https://news.itu.int/smart-villages-empowering-rural-communities-in-niger-2-0/>
- Izant, C. (2017). Equal access to public communications data for social media surveillance software. *Harvard Journal of Law & Technology*, 31(1), 237–257.
- Jaccard, N., Rogers, T., Morton, E., & Griffin, L. (2017). Detection of concealed cars in complex cargo x-ray imagery using deep learning. *Journal of X-Ray Science and Technology*, 25(3), 323–339.
- Jetzek, T., Avital, M., & Bjorn-Andersen, N. (2019). The sustainable value of open government data. *Journal of the Association for Information Systems*, 20(6), Article 6.
- Kaggle. (2017). *Passenger Screening Algorithm Challenge*. <https://www.kaggle.com/c/passenger-screening-algorithm-challenge>



- Kalizinje, F. (2018). Combating customs revenue fraud in WCO East and Southern African Region: A mirror analysis through the lens of Malawi. *Global Trade and Customs Journal*, 13(5), 224–233.
- Kitchin, R. (2014). Big data, new epistemologies and paradigm shifts. *Big Data & Society*, 1(1), 1–12. <https://journals.sagepub.com/doi/pdf/10.1177/2053951714528481>
- Kluttz, D., & Mulligan, D. (2019). Automated decision support technologies and the legal profession. *Berkley Technology Law Journal*, 34, 853–889.
- Kolokytha, S., Flisch, A., Lüthi, T., Plamondon, M., Schwaninger, A., Vasser, W., Hardmeier, D., Costin, M., Vienne, C., Sukowski, F., Hassler, U., Dorion, I., Gadi, N., Maitrejean, S., Marciano, A., Canonica, A., Rochat, E., Koomen, G., & Slegt, M. (2017). Improving Customs' border control by creating a reference database of cargo inspection x-ray images. *Technology and Engineering Systems Journal*, 2(3), 60–66.
- Laporte, B. (2011). Risk management systems: Using data mining in developing countries' customs administrations. *World Customs Journal*, 5(1), 17–27.
- Loo, R. (2019). The missing regulatory state: Monitoring businesses in an age of the missing regulatory state: Monitoring businesses in an age of surveillance. *Vanderbilt Law Review*, 72(5), 1563–1631.
- Lord, J., & Culling, A. (2016). OR In HM Revenue & Customs. *Impact*, 2(2), 30–33.
- Lum, K., & Isaac, W. (2016). To predict and serve? *Significance*, 13(5), 14–19.
- Lyon, D. (2014). Surveillance, Snowden, and big data: Capacities, consequences, critique. *Big data & society*, 1(2), <https://doi.org/10.1177/2053951714541861>.
- MacMillan, D., & Dwoskin, E. (2019, August 23). The war inside Palantir: Data-mining firm's ties to ICE under attack by employees. *The Washington Post*. <https://www.washingtonpost.com/business/2019/08/22/war-inside-palantir-data-mining-firms-ties-ice-under-attack-by-employees/>
- Malinowski, P. (2019). Application of modern technology for migration management. *European Law Enforcement Research Bulletin* (4 SCE), 29–33.
- Manokha, I. (2018). Surveillance: The DNA of platform capital — The case of Cambridge Analytica put into perspective. *Theory and Event*, 21(4), 891–913.
- Merz, F. (2019). Europe and the global AI race. *CSS Analyses in Security Policy*, 247.
- Mittelstadt, B., Allo, P., Taddeo, M., Wachter, S., & Floridi, L. (2016). The ethics of algorithms: Mapping the debate. *Big Data & Society*. <https://doi.org/10.1177/2053951716679679>
- Moore, G. (1965). Cramming more components onto integrated circuits. *Electronics*, 38(8), 1–4.
- Moore, G. (1975). Progress in digital integrated electronics. *IEEE, IEDM Tech Digest*, 11–13.
- NITI Aayog. (2018). *National strategy for artificial intelligence #AIFORALL*. [https://niti.gov.in/writereaddata/files/document\\_publication/NationalStrategy-for-AI-Discussion-Paper.pdf](https://niti.gov.in/writereaddata/files/document_publication/NationalStrategy-for-AI-Discussion-Paper.pdf)
- The Organisation for Economic Co-operation and Development (OECD). (2019). *Artificial intelligence*. <https://www.oecd.org/going-digital/ai/>
- The Organisation for Economic Co-operation and Development (OECD). (n.d.). *Open government data*. <https://www.oecd.org/gov/digital-government/open-government-data.htm>
- O'Neil, C. (2016). *Weapons of math destruction: How big data increases inequality and threatens democracy*. Broadway Books.
- Okazaki, Y. (2018). *Unveiling the potential of blockchain for Customs*. WCO Research Paper No. 45.
- Open Government Partnership. (2019). *Democracy beyond the ballot box: OGP's 2019 annual report*. <https://www.opengovpartnership.org/>
- Oxford Insights. (2018). *Towards an AI strategy in Mexico: Harnessing the AI revolution*. <https://www.oxfordinsights.com/mexico>

- Paunov, C., Planes-Satorra, S., & Ravelli, G. (2019). *Review of national policy initiatives in support of digital and AI-driven innovation*. OECD Science, Technology and Industry Policy Papers, No. 79, OECD Publishing. <https://doi.org/10.1787/15491174-en>
- Peeters, R., & Schuilenburg, M. (2018). Machine justice: Governing security through the bureaucracy of algorithms. *Information Polity*, 23(3), 267–280.
- Piscopo, C., & Birattari, M. (2008). The metaphysical character of the criticisms raised against the use of probability for dealing with uncertainty in artificial intelligence. *Minds and Machines*, 18(2), 273–288.
- Polner, M. (2018). Harnessing the power of data for customs enforcement. *Global Trade and Customs Journal*, 13(4), 182–185.
- Richardson, R., Schultz, J., & Crawford, K. (2019a). Dirty data, bad predictions: How civil rights violations impact police data, predictive policing systems, and justice. *New York University Law Review*, 94, 192–233.
- Richardson, R., Schultz, J., & Southerland, V. (2019b). *New challenges to government use of algorithmic decision systems*. AI Now Institute.
- Schiff, D., Biddle, J., Borenstein, J., & Laas, K. (2020). What’s next for AI ethics, policy, and governance? A global overview. *Proceedings of the AAAI/ACM Conference on AI, Ethics, and Society*, (pp. 153–158).
- Shalev-Shwartz, S., & Ben-David, S. (2014). *Understanding machine learning: From theory to algorithms*. Cambridge University Press.
- Shapiro, A. (2019). Predictive policing for reform? Indeterminacy and intervention in big data policing. *Surveillance and Society*, 17(3/4), 456–472.
- Stanford. (2020). *Artificial intelligence index report*. HAI Stanford.
- Sundong K., Tsai, Y-C., Singh, K., Choi, K., Ibok, E., Li, C-T. & Cha, M. (in press). DATE: Dual Attentive Tree-aware Embedding for Customs Fraud Detection. To appear in *Proceedings of ACM SIGKDD International Conference on Knowledge Discovery and Data Mining (KDD)*. San Diego, CA, USA, August 23-27, 2020.
- Supiot, A. (2015). *La gouvernance par les nombres: cours au Collège de France, 2012–2014*. Institut d’études avancées de Nantes.
- UK Government. (2017). *Government response to wider call for evidence from the House of Lords Committee on AI*. <http://data.parliament.uk/writtenevidence/committeeevidence.svc/evidencedocument/artificial-intelligence-committee/artificial-intelligence/written/73250.html>
- UK Government. (2018). *Industrial strategy: Artificial intelligence sector deal*. <https://www.gov.uk/government/publications/artificial-intelligence-sector-deal>
- UK Government. (n.d.). *Office of Artificial Intelligence*. <https://www.gov.uk/government/organisations/office-for-artificial-intelligence>
- US Government. (2019). *Executive Order on AI*. <https://www.whitehouse.gov/ai/>
- US Government. (2020). *2020 Action Plan*. <https://strategy.data.gov/action-plan/>
- Vanhoeveld, J., Martens, D., & Peeters, B. (2019). Customs fraud detection. *Pattern Analysis and Applications*, 23, 1457–1477. <https://doi.org/10.1007/s10044-019-00852-w>
- Wachter, S., Mittelstadt, B., & Russell, C. (2018). Counterfactual explanations without opening the black box: automated decisions and the GDPR. *Harvard Journal of Law & Technology*, 31(2), 842–887.
- Waldrop, M. (2016). The chips are down for Moore’s Law. *Nature*, 530(7589), 144–147.
- Wier, L. (2020). Tax-motivated transfer mispricing in South Africa: Direct evidence using transaction data. *Journal of Public Economics*, 184, 104153.

- World Bank. (2018). *Using big data to achieve the SDGs*. <https://www.worldbank.org/en/news/feature/2018/04/27/using-big-data-to-achieve-the-sdgs>
- World Customs Organization (WCO). (2019). *Study report on disruptive technologies*. <http://www.wcoomd.org/en/topics/facilitation/instrument-and-tools/tools/disruptive-technologies.aspx>
- World Customs Organization (WCO). (2020, February 19). BACUDA: Supporting Customs with data analytics. *WCO News*. <https://mag.wcoomd.org/magazine/wco-news-91-february-2020/bacuda/>
- World Economic Forum. (2019). *A framework for developing a national artificial intelligence strategy*. [http://www3.weforum.org/docs/WEF\\_National\\_AI\\_Strategy.pdf](http://www3.weforum.org/docs/WEF_National_AI_Strategy.pdf)
- Wylie, C. (2019). *Mindf\*ck: Cambridge Analytica and the plot to break America*. Random House Publishing Group.
- Xiao, Z., Xiao, H., & Wang, Y. (2016). A risk decision-making approach to customs targeting. *Open Cybernetics and Systemics Journal*, 10, 250–262.
- Yaqin, W., & Yuming, S. (2010). Classification model based on association rules in customs risk management application. *Proceedings – 2010 International Conference on Intelligent System Design and Engineering Application, ISDEA 2010. 1*, pp. 436–439. IEEE Computer Society.
- Zhou, X. (2019). Data mining in customs risk detection with cost-sensitive classification. *World Customs Journal*, 13(2), 115–130.
- Zuboff, S. (2015). Big other: Surveillance capitalism and the prospects of an information civilization. *Journal of Information Technology*, 30, 75–89.
- Zuiderwijk, A., Janssen, M., & Davis, C. (2014). Innovation with open data: Essential elements of open data ecosystems. *Information Polity*, 19(1, 2), 17–33.

## Notes

- 1 This article is based on the keynote speech at the WCO PICARD Conference held in Skopje, North Macedonia on 22–24 October 2019, delivered by the Secretary General of the WCO. The authors thank Ricardo Treviño, Yeon-Soo Choi, Shingo Matsuda, Rachel McGauran, Michelle Medina, Hans Pieters and Mariya Polner for their helpful comments.
- 2 Addressing the distinctions among all these technologies is out of the scope of this paper, which relies on a simple distinction between, on the one hand, data—that are increasingly produced and made available—and on the other hand, machines that treat them.
- 3 The massive use of data paves the way to ‘personalised law’, the possibility to adapt the law to each individual given their records (Devins et al., 2017). For example, in the US, around 200 risk analysis tools are used in justice procedures to support decision-making (Peeters et al., 2018).
- 4 For instance, Niger customs that have scarce resources to control a vast territory has deployed an IT network in more than 90 per cent of the customs units.
- 5 See WCO (2020), introductory page.
- 6 Didimo et al. (2002) and the Mexican tax revenue agency experimented with ML to guide its control strategy; it estimated that AI provided comparable outcomes in three months than manual work in 18 months, *Towards an AI strategy in Mexico* (Oxford Insights, p. 21).
- 7 World Bank (2018); see also ‘smart villages’ in Niger (ITU News, 2019) and the development of rural exchanges in India (NITI Aayog, 2018).
- 8 Up until recently, there was the famous Moore’s law on the computer’s capacities doubling every two years. Now that this increase has slowed down, this relative stagnation is considered as an opportunity to develop new technologies that will provide even more celerity than before (Moore 1965, 1975; Waldrop 2016).
- 9 <https://res.cloudinary.com/yumyoshojin/image/upload/v1/pdf/future-data-2019.pdf> and <https://res.cloudinary.com/yumyoshojin/image/upload/v1/pdf/cloud-business-2020.pdf>
- 10 Public open data is data collected or generated by public administrations and released publicly, either to restricted third parties like researchers or to the public domain.
- 11 <https://www.data.gov/>
- 12 <http://etalab.gouv.fr>. Etalab is managing the development of the governance-by-data in France, fueling and managing different websites as a warehouse for open data, a repository of open source software, shared code, and a series of use cases. Twenty-one projects were launched after a call for projects for administrations.

- 13 <https://www.openfiscaldata.go.kr> (which is only a small part of all Korean open data websites).
- 14 See for instance <https://sill.etalab.gouv.fr/fr/software>, in France, and the US National Geospatial Agency initiative <https://home.gs.mil/developer>
- 15 See OECD for a selection of national and international initiatives <http://www.oecd.org/going-digital/ai/initiatives-worldwide/>
- 16 <http://www.ansi.ne//motdg>
- 17 <https://www.etalab.gouv.fr/>
- 18 The Cambridge Analytica case unveiled the possibility to use personal data for political purposes by private companies, as well as the fact that these companies were conducting such operations worldwide before the scandal (Cadwalladr & Graham-Harrison, 2018; Wylie, 2019). In a last case opposing European Union and Google, the company was fined for having ‘imposed restrictions on [...] manufacturers and mobile network operators to cement its dominant position in general internet search’ (European Commission, 2018).
- 19 Australian Government, Vision 2025. <https://www.dta.gov.au/digital-transformation-strategy>
- 20 See for instance <https://www.douane.gouv.fr/la-douane/opendata>
- 21 <https://www.gov.uk/guidance/imports-and-exports-datasets>
- 22 <https://beta.sam.gov/> The US IRS put data as one of their six strategic objectives for 2018–2022. Between 2007 and 2017, the number of IRS users has been multiplied by 23, and the amount of data by 100. <https://www.irs.gov/pub/irs-pdf/p3744.pdf>
- 23 Regulation (EU) 2016/679 of the European Parliament and of the Council of 27 April 2016 on the protection of natural persons with regard to the processing of personal data and on the free movement of such data.
- 24 The ‘data ecosystems’ terms are often used in literature to define the relationships between states, citizens, and businesses to circulate and use data. Data ecosystems are supposed to foster peoples’ participation in public affairs (Zuiderwijk et al. 2014).
- 25 See the example of ‘smart walls’, <https://www.wired.com/story/palmer-luckey-anduril-border-wall/>
- 26 For instance, French customs and Internal Tax administration have been allowed by the 2020 law of finance to experiment with data collection on social networks for 3 years (2020 law of finance, article 154).
- 27 Civil disobedience regarding data provision is easy to imagine. Some companies prefer that their employees declare that they want to withdraw from some projects related to police, migration or intelligence services, rather than having to face whistleblowers later on (MacMillan & Dwoskin, 2019).
- 28 <https://datasciencecampus.ons.gov.uk/>

### Kunio Mikuriya



Dr Kunio Mikuriya has been Secretary General of the World Customs Organization (WCO) since 1 January 2009. Prior to joining the WCO, he worked for Japan’s Ministry of Finance for 25 years. During his career with the Ministry, Dr Mikuriya occupied a variety of senior posts, which have given him broad experience and knowledge in Customs, trade, development, budget, and financial policies. Dr Mikuriya has a degree in law from the University of Tokyo and a PhD in international relations from the University of Kent.

### Thomas Cantens



Dr Thomas Cantens currently works as resident Advisor of the Director General of Niger Customs. Formerly, he was the head of the Research Unit at the World Customs Organization, Brussels. He is an Associate Researcher at the research centre on international development of the Auvergne University (CERDI, France). He is a French Customs officer and has served in investigation and intelligence in France and in three sub-Saharan Customs administrations. Having initially graduated as an engineer (POLYTECH Montpellier, France), he holds a PhD in social anthropology (EHESP, France) and a certificate in geospatial analysis (ENSG, France). He has published several works on customs reform in developing countries.

# Why the future Revised Kyoto Convention should contain comprehensive rules of customs debt

*Hans-Michael Wolfgang, Achim Rogmann and Kerstin Harden*

## Abstract

---

The Revised Kyoto Convention (RKC) is currently being reviewed as part of an ongoing review process. The aim of the comprehensive review is to enhance the current provisions and advance them in order to meet today's needs and challenges. It is the intention of the World Customs Organization (WCO) that the RKC remains the blueprint for modern and efficient customs procedures in the 21st century. This should also apply to customs debt issues since customs debt law constitutes a central aspect of all national customs legislation. The status quo of the RKC does not, however, correspond to the fundamental role of this decisive area in customs law.

Against this background, this article deals with the motivations, extent and intermediate results of the present review process. Moreover, it examines the advantages and challenges of a comprehensive and harmonised implementation of the Convention. In particular, it addresses the proposal of establishing a global standard, a model law, regarding customs debt issues for national customs legislation that would foster transparency, facilitation and predictability, while at the same time reducing randomness and complexity. The article provides an insight into the status quo of the current RKC provisions relating to customs debt and looks at some national legislation regarding these issues. It illustrates why it is necessary that a future RKC includes harmonised standards and/or recommended practices regarding the incurrence, payment and extinguishment of a customs debt and it also elaborates on the principles and concepts, such as the economic theory of customs, that should be reflected and included in a possible system of customs debt provisions.

---

## 1. The comprehensive review of the Revised Kyoto Convention

### 1.1 Background, proceeding and intermediate results

In June 2018, the WCO Policy Commission and Council decided that it was time to review the RKC and approved the setting up of a Working Group with three subgroups working intersessionally. The review is supposed to be comprehensive, covering both the structure and content of all provisions of the RKC, including the Body of the Convention, the General Annex (GA), the Specific Annexes (SAs) and the Guidelines.

The motivation for such an extensive review is that the RKC, which entered into force in 2006, should be adapted to meet today's needs and challenges. The Convention is supposed to remain a blueprint for modern and efficient customs procedures in the 21st century. Consequently, it has to be progressive and flexible enough to meet these requirements and expectations. For this reason, all provisions (standards, recommended standards etc.) as well as the structural system of the current version are mooted.

Against this background, a review process was started in September 2018. After having agreed on a general way of proceeding, the WCO called for proposals for improving or changing the RKC. To ensure an inclusive approach to the review, external stakeholders—such as other international organisations, regional organisations, industry associations, the private sector, development partners and academia—were encouraged to participate and engage. So far, some 170 proposals relating to 37 concepts have been submitted by members and external stakeholders. Most of these have also been presented, discussed and debated in the several meetings of the RKC Working Group. Moreover, challenges and benefits of implementation of the RKC have been continuously discussed in seven extensive meetings of the Working Group so far.

For the purposes of classification, and in order to handle the high amount of proposals, a tracking system has been established that categorises and ranks the different suggestions according to their level of maturity. Track 'D' and 'C' category proposals are not convincing or lack the necessary substantial input that is needed to understand and progress the suggestions. Proposals are placed in the 'B' category where there is no agreement among the members of the RKC Working Group and are thus put on hold pending provision of further information by the proponent. Finally, a proposal is placed in the 'A' category if the members agree on it and it is elaborated sufficiently to move forward in the review process.

After these intermediate results, all proposals and concepts that have been classified in or upgraded to the 'A' category will move on to the next stage of the review process and will be subject to more concrete measures. These steps will include legal drafts of the provisions and more in-depth discussions on the details. It is the aim of the WCO to complete the review and to adopt the new Convention in 2021. Due to the global outbreak of the coronavirus, meetings of the RKC Working Group have had to be postponed, which may lead to a modified schedule for completion of its work.

### **1.2 Advantages of an appropriate and harmonised implementation**

The instrument of the RKC has laid down the global standard for all modern Customs legislations since 1999 (WCO, 2008) covering, *inter alia*, customs obligations and controls, customs declarations and customs procedures. It aims to simplify international trade. This aim can most effectively be reached by advancing its harmonised and comprehensive implementation.

First of all, one has to remember why a reasonable implementation of the RKC is important and necessary. The main reason is based on global trade challenges, such as the growing importance of global value chains, the burgeoning corpus of bilateral and regional free trade agreements, digitalisation and the other significant technological developments of the past years (for information on trade challenges see Wolfgang & Rogmann, 2019). Moreover, there are a number of other socio-economic developments with significant effects on Customs and international trade, such as increasing populations, shifts in economic and political centres of power, the lack of sustainable economic development, the need to protect the environment, risks associated with international supply chains, and nationalisation tendencies or misgivings about globalisation.

Against the background of all these global challenges, an appropriate and harmonised implementation of the RKC results in more predictability and certainty of the law, a better and comprehensive harmonisation of customs procedures and processes and, consequently, it would result in even more compatibility among the different national legislations. This alone will lead to more trade facilitation and thus support the goals of the RKC.

In addition to these aspects, a reasonable and harmonised implementation of the RKC would be extremely efficient and beneficial to all member countries. At the level of the World Trade Organization (WTO), the Trade Facilitation Agreement (TFA) regulates many trade simplifications, which are already contained in the RKC (Wolffgang & Kafeero, 2014). If the TFA is implemented worldwide, the WTO predicts an average additional annual economic growth of 0.9 per cent for developing countries and 0.25 per cent for industrial nations. It has to be admitted that there are no statistics for the RKC, but a comprehensive implementation of the RKC could considerably exceed the estimates of the WTO since the provisions of the TFA are rather vague, whereas those of the RKC are far more specific (Wolffgang & Rogmann, 2019).

### **1.3 Challenges and issues**

The comprehensive implementation of the Convention holds many advantages but at the same time it confronts the WCO and its members with the challenge to cope with a legal structure not designed for simple transformation into national legislation. The main reasons for the difficulties regarding an appropriate implementation process result from the legal structure of the RKC itself and the need to enhance cooperation in customs practice.

#### **Legal structure of the RKC**

The current nature of the provisions of the RKC and their binding character do not satisfy the requirements that a blueprint for modern and efficient customs procedures in the 21st century, a model for national legislation, should show. The provisions should be made more binding in order to guarantee a more harmonised implementation followed by gains and advantages that all WCO countries could benefit from. The status quo is that the provisions of the RKC show shades and differences in their degree of obligation. The binding force of the provisions is different.<sup>1</sup> Even the legal components of the RKC have an unequal legal character.<sup>2</sup>

For instance, the members' freedom in deciding their commitment regarding the Specific Annexes or just some of its chapters and the possibility to make various reservations against the contents result in a fragmentation of law. So, the possibility of picking the provisions a member wants to be committed to also leads to a fragmentation of implementation since the content of this implementation differs from state to state, depending on the number of accepted Specific Annexes and recommended practices. Of course, this is already an improvement compared to the previous version of the RKC in 1973 and it is, according to international law, more binding. However, the fact that the Specific Annexes lack a necessary degree of commitment might obstruct and delay a reasonable and efficient implementation of the RKC as a whole.

At least from an academic perspective, a future RKC should be more mandatory than its current version, coming closer to a global model law for national customs legislation. This would greatly increase its advantages and result in a more appropriate and harmonised implementation. At the same time, a future convention must permit a certain degree of flexibility in order to satisfy the different members' stages of development.

It should be taken into consideration that national legislation follows developments and has to manage situations which are—in many cases—unpredictable and cannot be planned in advance.

So there must be appropriate solutions in the provisions.

A more binding character of the RKC could be achieved by principles that are already known under international law but nevertheless guarantee a certain degree of flexibility:

- More provisions or all provisions in the Specific Annexes should be binding.
- Members should not have the option to pick the provisions they want to be committed to or a member's reservations should be limited or not accepted without the consent of other members.
- The principle of reciprocity or mutual administrative assistance should apply: a contracting party should be obliged to render assistance to another one only when both parties have accepted the same annex.<sup>3</sup>

A compromise approach could be that different transitional periods of implementation for the member states are determined according to their stage of development. The difference and advantage over the status quo is that there would be specific timelines that may act firstly as indicative and later as definitive dates of implementation. These timelines could also be combined with other instruments of flexibility.<sup>4</sup> Admittedly, this would again, even though just temporarily, lead to a fragmentation of law.

Nations could even go a step further and consider combining the RKC with other instruments, such as the SAFE Framework of Standards to Secure and Facilitate Global Trade or other WCO standards, into a single code that is legally binding. As WCO standards are currently fragmented, a comprehensive instrument could prove very helpful and powerful and not only with regard to its implementation.

### **Customs-related cooperation**

All the current global trade challenges demand greater cooperation when it comes to Customs. This customs-related cooperation itself is a challenge, too. It includes not only customs administrations, companies or other players in the international trade but also international organisations like the WCO and their instruments as well as public and private sector stakeholders in the area of international trade, logistics, safety and security.<sup>5</sup> The WCO should direct and further enhance the goal of such a global partnership.

A harmonised implementation of the RKC could help to enhance cooperation that is needed to face the current and future global challenges. The WCO itself should respond to the challenges as proactively as possible and issue regulations and standards in a more mandatory manner. Consequently, the challenge for Customs lies in implementing the available legislative framework as effectively as possible. However, there must also be a rethink when it comes to the implementation of future customs rules. It is possible to increase the effectiveness and efficiency of the limited resources available to customs administrations by increasing partnerships between them and economic operators (i.e. more 'trust' in trusted traders and less interference in the trade supply chain).

## **2. Proposal for a global standard of customs debt rules**

The RKC aims to simplify and harmonise customs procedures. The past has shown that this aim has already been performed and worked well for many areas that are regulated in the Convention. The importance and necessity of a comprehensive review of the RKC for modern and efficient customs procedures as well as its desired harmonised implementation are obvious and have already been illustrated above.<sup>6</sup> These aspects of harmonisation and simplification should also apply to customs debt issues since customs debt law constitutes a central aspect of every national customs legislation. The current RKC does not reflect the need to deliver a standard for customs debt provisions so far. For this reason, global standards regarding customs debt issues should ideally form part of the future Convention in order to achieve a sufficient degree of harmonisation of customs procedures and practices.



## 2.1 Importance for Customs, customs procedures and rulings

Customs debt law is a central and decisive element in every import and—if applicable—export process. In this regard, it makes a great difference whether goods arriving or leaving a country are immediately subject to the incurrance of a customs debt or whether the customs clearance is paused or pending. The latter option incurs more operating expense for both the customs authorities and the economic operators. Furthermore, an appropriate customs debt law will help and support a state to levy the relevant customs duties. All this means that a comprehensive system of customs debt rules is indispensable for the efficient processing of the flow of commodities while at the same time ensuring the correct levying of customs duties.

Moreover, all customs procedures are closely connected to issues of and around the incurrance of a customs debt. At the end of every customs procedure the question about a possible customs debt is normally raised. For instance, in relation to the warehouse procedure, no customs debt incurs as long as the goods are placed under this regime. If the goods are removed from the warehouse they have to be either released for free circulation, with the consequence that a customs debt arises, or they are removed from the customs territory of the respective country with the consequence that no customs debt arises. This principle also applies to other customs procedures (such as transit, inward processing or temporary admission) that avoid the incurrance of a customs debt and thus customs duties. This also shows that the question of customs debt and payment of customs duties is an important factor and outcome before and after all customs procedures. Consequently, the circumstances under which a customs debt on import or export is incurred and other relevant factors in this context (such as time, place, possible debtors or extinguishment)<sup>7</sup> should be clarified, defined and set out in harmonised provisions.

Besides their importance for customs procedures, issues of customs debt law directly or indirectly affect other customs rulings. For instance, the time at which a customs debt is incurred is important for determining the customs value of goods or the relevant tariff rate and thus for the amount of the customs duties that have to be paid by the economic operator. Moreover, in some national legislations not only the customs value but also the customs debt, if such rules exist, are dependent or interlinked with the incurrance and assessment of other domestic duties and taxes, such as VAT.

All these different aspects of customs processes and their interdependence to the field of customs debt show the global importance of and the need for customs debt rules that provide more concrete guidance to national legislation.

## 2.2 Advantages of comprehensive rules on customs debt

Having illustrated the relevance of customs debt provisions in general, the next step is to show what kind of advantages comprehensive rules would entail. Besides the fact that a global standard would achieve a sufficient degree of harmonisation of customs procedures and practices among the different national legislations and lead to a better interoperability, such provisions will also lead to greater legal certainty for customs authorities and economic operators. Moreover, a comprehensive and coherent customs debt law will help to better levy customs duties as public revenues that some countries are reliant on.

In practice, the rules will enhance and optimise the transparency and predictability of law for all involved parties. Furthermore, newly designed provisions on customs debt issues will contribute to the facilitation of international trade by minimising ambiguities and complexity of (different) import and export formalities. All in all, they will foster a better cooperation between customs and traders. For nations highly dependent on the revenue generated by import and export duties, it is of high importance to have resilient rules on how and when duties can be levied.

## 2.3 Status quo ...

In order to achieve globally standardised customs processes, it is essential to establish harmonised provisions on customs debt issues that would otherwise form obstacles to trade. Rules governing aspects of customs debt are essential in the application of customs provisions and play a fundamental role. However, this important role is not adequately mirrored in the current RKC provisions. Remarkably, the existence and handling of such rules and related questions are not at all, not extensively or not sufficiently addressed in most national customs legislations. Accordingly, there is a global lack of comprehensive and essential rules and associated details to satisfy the important needs of customs debt management. This is surprising, since customs debt law constitutes a central aspect and should form a core element of every national customs legislation.

### ... in the RKC

The determination of the status quo regarding customs debt rules in the RKC is sobering. The current version of the Convention does not specify rules governing customs debt so far. Chapter 4 of the RKC's General Annex merely contains standards, leaving the discretion to define the following aspects to national legislation:

- the circumstances when liability to duties and taxes is incurred (Standard 4.1)
- the time period within which the applicable duties and taxes are assessed (Standard 4.2)
- the factors on which the assessment of duties and taxes is based and the conditions under which they are determined (Standard 4.3)
- the point in time to be taken into consideration for the purpose of determining the rates of duties and taxes (Standard 4.5)
- the methods that may be used to pay the duties and taxes (Standard 4.6)
- the person(s) responsible for the payment of duties and taxes (Standard 4.7)
- the due date and the place where payment is to be made (Standard 4.8). When national legislation specifies that the due date may be after the release of the goods, that date shall be at least 10 days after the release. No interest shall be charged for the period between the date of release and the due date (Standard 4.9)
- the period within which Customs may take legal action to collect duties and taxes not paid by the due date (Standard 4.10)
- the rate of interest chargeable on amounts of duties and taxes that have not been paid by the due date and the conditions of application of such interest (Standard 4.11)
- the specification of conditions under which deferred payment is allowed where such facility is provided for (Standard 4.15).

After this inventory-taking, one has to conclude that the RKC does not adequately address aspects related to customs debt and that there is a lack of comprehensive and necessary specifications.

A future RKC can fulfil its objective to harmonise customs procedures and practice only if it delivers detailed standards for these aspects of customs debt provisions. In order to achieve this, the existing general standards in Chapter 4 of the RKC should be revised and enhanced to the next level. They should be extended and filled with more specific content elaborating a system of provisions regarding the incurrence, payment and extinguishment of a customs debt. In this context, the already existing nonbinding General Annex Guidelines to Chapter 4 could also be incorporated or considered. The extent of these Guidelines itself shows that there is a need for standardised provisions.

### ... in different national customs legislations

Coming from the status quo of the RKC, it is also of interest whether and to what extent customs debt rules are present in national or regional customs legislation. For this purpose (and to get an impression about the status quo at national level), we will briefly elaborate on some examples.<sup>8</sup>

The European Union provides in its Unions Customs Code (UCC)<sup>9</sup> in Title III ‘Customs Debt and Guarantees’ different chapters and detailed sections concerning customs debt issues.<sup>10</sup> General customs debt issues such as the incurrence of a customs debt, the guarantee for a potential or existing customs debt, recovery, payment, repayment and remission of the amount of import or export duty and the extinguishment of a customs debt are laid down. In Chapter 1 ‘Incurrence of a customs debt’ customs debts on import (Art. 77–79 UCC) and customs debts on export (Art. 81–82 UCC) are distinguished. Moreover, the UCC differentiates between regular customs debts (Art. 77, 81 UCC) and customs debts in irregular cases through noncompliance (Art. 79, 82 UCC). Every provision on incurrence also governs the time at which the customs debt is incurred and specifies the possible debtors. The places where the customs debt is incurred are specified in Art. 87 UCC. The system is completed by Art. 124 UCC, which lists several cases in which a customs debt is extinguished.<sup>11</sup> Art. 125 UCC finally ensures the application of penalties for failure to comply with customs rules even though a customs debt that was incurred due to noncompliance has been extinguished. From this it can be concluded that the incurrence of a customs debt is not seen as a punitive instrument. This approach is supported by Art. 42 UCC, which demonstrates that penalties must be imposed as a separate instrument.

While the first example shows a comparably detailed system of provisions, other national customs legislations do not have a coherent system concerning customs debt aspects or they lack any such rules. For instance, the Chinese customs law does not currently provide particular rules for customs debt issues. The Customs Law of the People’s Republic of China<sup>12</sup> gives, however, some indications regarding the time of incurrence of a customs debt in Chapter V under the heading ‘Customs Duties’. An explicit time of incurrence of a customs debt is not defined. Art. 29 regulates that imported or exported goods are not released by the customs authorities until taxes and duties or a security have been paid. Art. 53 states that duties shall be collected on goods permitted to enter or leave the country. From these provisions it can be concluded that a customs debt in China incurs even before the goods have entered into the economic cycle of a country and that a customs debt only incurs if goods are allowed for import or export. Art. 54 governs which persons are obliged to pay the customs duties.

For India, the Supreme Court held that the liability to pay customs duties is not a common law liability. It arises by virtue of the provisions of the Customs Act only.<sup>13</sup> Despite this clear assignment to the legislator, the Indian Customs Act<sup>14</sup> is silent on the term ‘customs debt’, even if Section 2 contains a wide range of definitions, including those for the terms ‘duty’ and ‘assessment’. Moreover, searching for the terms ‘customs debt’ or ‘liability to duties’ does not lead to a result in the whole Customs Act. A conjoint reading of Sections 12(1) with Sections 2(18), 2(23) and 2(27) of the Customs Act clarifies that customs duty can be levied only on goods imported or exported beyond the territorial waters of India (Mukherjee, 2019, p. 141), leaving the question relating to the time of duty occurrence. Section 15(c) clarifies that payment of the duty is not dependent upon lodgement of a bill of entry without providing an express rule on the taxable event (Mukherjee, 2019, p. 146). Gaps left in the comprehensive statute law have been filled by case law. In general, the person liable to pay duty in the case of imports is the importer.<sup>15</sup> However, the clearing agent can also be made liable. In the case of *Union of India v. Shri Harkishandas Narottam Hospital*<sup>16</sup> it was held for confiscated goods that the possessor of the goods shall bear the liability to pay duty and that this liability does not shift to the person who either imported the goods or to a person from whose possession the goods were seized. Without doubt, core elements of customs debt law cannot be gathered from the Customs Act itself. A less opaque legislation could increase the trade facilitating effect of transparent and well-structured rules on customs debt.

In the Statutes of the Republic of Singapore Customs Act (Singapore Government, 2004) a search for special customs debt provisions is in vain. However, Part III ‘Levying of duty and tax’ governs, in Art. 10 of the Customs Act, the general levying of duties. The incurrence and the time of the incurrence of a customs debt on export or import are not contained in the rulings. Art 28 of the Customs Act, however, defines the time of importation when duty is imposed. Part XV of the Act lists offences against customs rules and procedures and defines penalties for these offences.

Looking at the Common Customs Law of the Gulf Cooperation Council (GCC, 2002), some provisions can be found with regard to customs debt issues in Section II, among the principles of the application of the customs tariff. Art. 9 of the Code states that imported goods are subject to the customs taxes (i.e. ‘duties’) specified in the customs tariff. This governs the incurrence of a customs debt. Regarding the time of the incurrence Art. 13 of the Code provides that the customs debt normally incurs at the date of registering the customs declaration with the customs offices. This is, according to Art. 14 of the Code, similar for goods that have previously been deposited in a warehouse.

The national customs legislation of Australia does not contain a coherent system of customs debt rules at this stage either. But in comparison to other national legislation, Art. 132AA of the Customs Act of 1901<sup>17</sup>, Part VIII ‘The Duties’ defines when an import duty must be paid. Besides the description of goods, the time by which the duty on goods must be paid is also specified. As part of the common law and as a typical characteristic of its legal tradition, the Australian law is also defined by case law. In this context, there can be found some judicial decisions that examine some of the issues that are not covered by the provisions of the Customs Act, such as the question of possible customs debtors in case of noncompliance with customs rules<sup>18</sup> or the question of liability for unpaid customs duties.<sup>19</sup>

Summing up, the overview of some national legislation on customs law has shown that, to a large extent, an insufficient degree of regulation in the field of customs debt law exists. Provisions are not, or not sufficiently, provided for or they are not coherent, are too diverse or are not explicit enough. They are rather hidden between rules regarding other fields of customs law or in separate taxation Acts. A more precise rule on WCO level in a new RKC would overcome this, lead to more harmonisation and will finally enforce the advantages of comprehensive customs debt provisions on a national level.

## 2.4 Principles to be reflected

The previous discussion has shown the need for action and that the provisions of the RKC should be revised and enhanced to the next level, which will have a binding effect on national customs legislations. The authors believe that it is essential for a modern and comprehensively reviewed RKC to consider and address the subject of customs debt. This is why a proposal for a legal framework as global standard for customs debt rules has been put forward. In general, the following principles should be reflected in the development and redesign of the provisions of a future RKC.

### **Incurrence of a customs debt according to the ‘economic theory of customs’**

The core aspect of the first general principle is to base the incurrence of a customs debt in the RKC only on objective, transparent and predictable criteria, which means according to the ‘*economic theory of customs*’. Under this subject heading, the theory is understood as a general concept according to which a customs debt is supposed to arise. A customs debt should only arise according to objective, transparent and predictable criteria and should not depend on arbitrary or subjective factors.

What criteria define the ‘economic theory of customs’? It is labelling the concept or the fundamental idea that only goods that positively and factually participate in the economic cycle of a customs territory and thus step into competition with domestic products are subject to the incurrence of a customs debt and the assessment of customs duties.<sup>20</sup> For goods that just transit the customs territory or that are part of a special customs procedure avoiding duties, a customs debt shall not (yet) be incurred.<sup>21</sup> The same applies to pure noncompliance with customs provisions. Otherwise, the incurrence of a customs debt would

have the character of a penalty in such cases, a concept that would not comply with the economic reasons that form the basis of the economic theory. Consequently, it should be considered that the incurrence of a customs debt must not be a sanction but a means of economic reasons. Noncompliance with customs provisions might result in sanctions specified by national legislation that do not comprise the incurrence of a customs debt. In short, a customs debt should be a means of economic reasons related to the factual participation of goods in an economic cycle of a customs territory and not a sanction or an arbitrary or subjective means to levy duties.

Moreover, it must be stated that the economic theory of customs, although it might not be labelled as such, is not a new concept that would be introduced into the future RKC. The concept of the economic theory of customs is a historic one and integral to the provisions concerning the customs procedures of the RKC of 1999<sup>22</sup> and its previous version of 1973. The concept is even reflected in the provisions of the International Convention relating to the Simplification of Customs Formalities—established by the League of Nations in 1923 (League of Nations, 1924–1925). This Convention is the first international convention in the field of customs and is a legal predecessor of the Kyoto Convention of 1973 (Asakura, p. 272). The economic theory of customs corresponds to the spirit and purpose of these provisions. Consequently, the general principles of this concept that have been explained above are already intrinsic to other RKC provisions and thus are already indirectly established and well-known at the WCO level.

In general, it seems to be necessary and appropriate that this theory or concept, which already forms the basis of the customs provisions, should be the basis for possible future standards or recommended practices of harmonised customs debt provisions. Mirrored to the case of export duties, the economic theory leads to the consequence that a customs debt on export can only occur when goods are leaving the economic cycle of a customs territory.

### **Import vs export customs debts**

As a second principle and in order to provide clearly defined rules, future customs debt provisions should distinguish between the incurrence of a customs debt on import and customs debt on export. This would be in line with the definition of import and export duties and taxes in Chapter 2 of the General Annex.

The concept of ‘customs debt’ should refer and be restricted to those import or export duties and taxes that incur in terms of Art. II GATT. This does not include national duties that secure a non-discrimination of domestic and foreign goods and not fees and charges commensurate with the costs and services rendered.

### **Regular vs irregular customs debts**

In addition to the aforementioned characteristics, rules should also distinguish between ‘regular’ customs debts and customs debts in ‘irregular cases’ on import or export. A regular case means the release for free circulation or temporary admission with only partial relief of import duties. Customs debts in ‘irregular cases’ would be, for example, smuggling, the unauthorised removal of goods from a customs warehouse or other defined cases of noncompliance with customs provisions.

This distinction allows the customs authorities to identify cases in which duties might have to be levied due to noncompliance. In such cases, a customs debt initially incurs because the goods might have entered the economic cycle of a customs territory. However, under certain circumstances, mistakes, negligence or noncompliance that demonstrably do not lead to a final and factual entry of the goods into the economic cycle might be qualified for non-occurrence or a later extinguishment of the customs debt. This means that the incurrence of irregular customs debts temporarily secures a state’s claim to customs duties. It is not meant to be a sanction since the economic operator may prove that their noncompliance had no significant effect on the correct operation of the customs procedure. Nevertheless, such cases of noncompliance might entail sanctions on national level—apart from the incurrence of a customs debt—that must be defined.

### **Treatment of prohibited and restricted goods**

According to the fourth principle, the RKC should clarify that customs debts on import and export are incurred even where they relate to goods that are subject to measures of prohibitions or restrictions, except in cases specified by national legislation. It would be of advantage to clarify these principles of customs debts incurrence because the prohibition of goods as such shall not exempt them from the general obligation to be subject to customs duties. It should be clarified that customs debt provisions, in principle, do not distinguish between legal and illegal transactions. Consequently, illegally imported goods cannot be exempted from the incurrence of a customs debt. Relevant for the incurrence of a customs debt on import is the factual entry and participation of the goods in the economic cycle of a customs territory of a country or customs union.<sup>23</sup> This is surely the case if goods have entered a customs territory and are later (by chance) discovered, confiscated or secured by the enforcement authorities.

However, there could be defined exceptions, rules of extinguishment of such a customs debt or cases specified by national legislation that follow the approach to the non-incurrence of a customs debt and thus no assessment of customs duties for goods (such as, for example, counterfeit money or narcotic drugs and psychotropic substances as banned by international conventions) that, according to their nature, are not suitable to participate in the (legal) economic cycle of a customs territory of a country at all. This consequence shall not prevent members from applying sanctions related to the unlawful import of goods into the customs territory.

Hence, the reason to clarify the occurrence of customs debts especially for prohibited or restricted goods is basically to ensure the consistency and coherence of the system of the incurrence of customs debts.

### **Time and place of incurrence**

The time and place at which the customs debt is incurred should be established for regular and irregular cases as well. This will be, on the one hand, of use for the assessment of customs duties. It should be stipulated that the amount of import or export duty shall be determined on the basis of the rules determining the duty that was applicable to the goods concerned at the time the customs debt was incurred or in specific cases for a certain time. This applies to the rules of assessment like tariff rate or customs value of the goods in question. On the other hand, defining the place of the incurrence might also be important and relevant when it comes to questions regarding the competence of customs authorities and their capacity to act.

### **Customs debtor(s)**

Another aspect that should be considered and reflected in future provisions of customs debt under the RKC are rules on the identity and liability of the possible customs debtor(s). Such rules or guidelines would again lead to more legal certainty and predictability for both the customs authorities and the economic operators. Especially for the customs authorities, such rules would facilitate the identification of the possible customs debtor(s) and their liability and thus the process of levying the duties and taxes.

The accurate, transparent and predictable identification of possible customs debtors is important since in individual cases there is often more than one person who may be liable for a customs debt. Moreover, it is possible that the number of possible customs debtor(s) differs from case to case according to the characteristics and nature of the incurred customs debt.<sup>24</sup>

In the case that several persons are liable for the payment of import or export duties and taxes, they shall be liable jointly and severally. This implies that customs authorities have a certain discretionary power and may, where appropriate, choose between the possible customs debtors.<sup>25</sup>

### **Extinguishment of customs debts**

Another principle that should be integrated into the RKC refers to rules on the extinguishment of customs debts. Such rules should allow for the interests of the debtor(s) and reflect the principle that goods which have demonstrably not entered the economic cycle of a customs territory are no longer subject to a customs debt.

The need to establish rules on the extinguishment of customs debt results from determined situations in which a customs debt no longer exists due to certain circumstances. For instance, a customs debt might be extinguished by payment or remission of the amount of import or export duty or after expiry of the limitation period. At the same time, provisions on the extinguishment of a customs debt can be used as an instrument for correcting unreasonable and unfair outcomes for economic operators since the incurrence of a customs debt itself should not be a sanction. In practice, such cases that could be resolved by the extinguishment of the customs debt could be for example:<sup>26</sup>

- Goods liable to import or export duty are confiscated or seized and simultaneously or subsequently confiscated
- Goods liable to import or export duty are destroyed under customs supervision or abandoned to the state
- The disappearance of the goods or the non-fulfilment of obligations arising from the customs legislation results from the total destruction or irretrievable loss of those goods as a result of the actual nature of the goods or unforeseeable circumstances or force majeure, or as a consequence of instruction by the customs authorities; for the purpose of this point, goods shall be considered as irretrievably lost when they have been rendered unusable by any person
- The customs debt was incurred pursuant noncompliance with customs provisions but
  - (a) the failure which led to the incurrence of a customs debt had no significant effect on the correct operation of the customs procedure concerned and did not constitute an attempt at deception
  - (b) all of the formalities necessary to regularise the situation of the goods are subsequently carried out
- The customs debt was incurred pursuant to noncompliance with customs provisions and evidence is provided to the satisfaction of the customs authorities that the goods have not been used or consumed and have been taken out of the customs territory.

### **Factors and timeframe of assessment**

More detailed provisions governing factors on which the assessment of customs and duties is based and the conditions under which they are determined should be provided. Rules on customs valuation (for *ad valorem* duties) should refer to the provisions of the WTO Agreement on Customs Valuation (WTO, 1994) or stipulate alternative methods for determining the value of the goods.

It would also be useful for a timeframe to be defined under which duties and taxes are assessed after incurrence (regular customs debt) or after customs authorities are aware that a customs debt is incurred (irregular customs debt). Furthermore, procedural rules on notification of the customs debt should be provided.

### **Timeframe for payment and administrative measures**

A timeframe should be defined for the period within which Customs shall and may take administrative measures to collect duties and taxes not paid by the due date. This could include all administrative actions taken by Customs to collect import and export duties (and related taxes), depending on national provisions for enforcing customs debt provisions. This might include commencement of court procedures if national administrative procedure law requires. The timeframe should also define the period of limitation after which Customs is precluded from commencing procedural measures to collect unpaid duties.

### **2.5 Adherence to and consideration of standards of other agreements**

In addition to the principles that have been discussed above, the future RKC should not fall short beyond the rules of other agreements in this field, such as the rules governed by the TFA (WTO, 2014; Wolfgang & Kafeero, 2014). For example, Article 7:2 TFA requires that each member shall, to the extent practicable, adopt or maintain procedures allowing the option of electronic payment for duties, taxes, fees and charges collected by Customs incurred upon importation and exportation. This provision delivers a more precise condition compared to Standard 7.1 of the RKC.

Article 7:3 TFA provides for separating the release of goods from the final determination of duties, taxes, fees and charges, which may require the lodgement of a guarantee. The RKC should reflect this need for separation and also comprehensive provisions on guarantees (security) to cover customs debts based on the existing provisions of Chapter 5 GA RKC.

Furthermore, Article 7:7.3 (d) TFA establishes the option of deferred payment of duties, taxes, fees and charges as a potential measure to grant enhanced trade facilitation for Authorized Operators.

## **3. Outlook and perspectives**

It is the intention of the WCO that the RKC remains the blueprint for modern and efficient customs procedures in the 21st century. To cope with political, legal and technical developments and changes that will shape the future of trade and the future of Customs, it is necessary to adapt and adjust to these different challenges. This might also require instruments on trade facilitation and supply chain security developed outside the RKC to be integrated into the RKC, keeping in mind that any future instrument should serve as a model for legislation in individual states to a much greater extent than it has been the case so far. To this end, the degree of regulation and its effect must be significantly increased, ideally, towards a legally binding international agreement which might even function as a global model law. In this context, an appropriate and harmonised implementation of the RKC presents another challenge to the WCO and its members. However, this task is, compared to the various advantages that go along with such a comprehensive implementation process, worth tackling consistently.

A future RKC could even better meet its objective of harmonising customs procedures and practices by delivering more detailed standards or recommended practices regarding customs debt provisions. Customs debt law is a central element of any national customs legislation, although this is not mirrored yet on all national levels. The status quo of the RKC provisions does not correspond to the fundamental role of this decisive area in customs law. Accordingly, it is important to advance, extend and specify the rulings in Chapter 4 of the Convention so that a system of provisions regarding customs debt is formed. This would simply be the next consequential step in harmonising customs processes. In this context, the consideration of the principles elaborated on above will, among other things, contribute to a harmonised good practice in customs, ensure better cooperation with customs authorities and facilitate customs processes in general, and thus lead to a considerable improvement in the transparency of customs rules with predictable enforcement.



Consequently, it is desirable and necessary to develop and establish a global standard or a model law on all relevant customs debt issues for adoption in national customs legislation. Concluding and summing up, a future RKC should include harmonised and more detailed provisions (to the extent possible, binding standards or at least recommended practices) regarding customs debt issues, particularly rules governing the incurrence, payment and extinguishment of a customs debt. They should provide guidance and achieve a sufficient degree of harmonisation of customs procedures and practices, while at the same time fostering transparency, legal certainty, trade facilitation and predictability, and reducing ambiguity and complexity. Sound provisions on customs debt can contribute to a comprehensive and future-proof convention.

## References

- Asakura, H. (2003). *World history of the customs and tariffs*. World Customs Organisation.
- Australian Government. (2013). *Customs Act 1901 (No. 6, 1901 as amended)*. <https://www.legislation.gov.au/Details/C2013C00381>
- European Union (EU). (2013). Regulation (EU) No 952/2013 of the European Parliament of the Council of 9 October 2013 laying down the Union Customs Code. *Official Journal of the European Union*. <https://eur-lex.europa.eu/legal-content/EN/TXT/PDF/?uri=CELEX:32013R0952&from=EN>
- General Administration of Customs, People's Republic of China. (n.d.) *Customs law of the People's Republic of China*. <http://english.customs.gov.cn/Statics/644dcaee-ca91-483a-86f4-bdc23695e3c3.html>
- Gulf Corporation Council (GCC). (2002). *Common customs law: Rules of implementation and explanatory notes*. Dubai Customs. <https://www.dubaicustoms.gov.ae/en/Publications/Documents/GCCCommonCustomsLawEnglish.pdf>
- Lamp, K. (1915). Zollpolitik und Zollrechtstechnik (Customs policy and law technology). *Zeitschrift für die gesamte Staatswissenschaft (Journal of Institutional and Theoretical Economics)*, 71(4), 505–555.
- Lamp, K. (1917). *Die Theorie des deutschen Zollrechts und der Entwurf einer neuen österreichischen Zollordnung (The theory of German customs law and the draft of a new Austrian customs order)*. Tubingen.
- League of Nations. (1924–1925). International Convention relating to the Simplification of Customs Formalities. *League of Nations Treaty series*, 30(775), 371–385. <https://treaties.un.org/doc/Publication/UNTS/LON/Volume%2030/v30.pdf>
- Lyons, T. (2018). *EU Customs Law*. 3rd ed. Oxford EU Law Library.
- Michaelis, G. (1981). Die besonderen Zollverfahren und ihre wirtschaftlichen Grundlagen - eine Übersicht. [‘Special customs procedures and their economic principles – an overview’]. *Zeitschrift für Zölle und Verbrauchsteuern [Journal for Customs and Excise]*, 3543–59.
- Mukerjee, T. P. (2019). *Commentary on The Customs Act, 1962 (Act No. 52 of 1962)*. 16th ed. Delhi Law House.
- Singapore Government. (2004). *Customs Act (Chapter 70)*. Singapore Statutes Online. <https://sso.agc.gov.sg/Act/CA1960>
- Witte, P., & Wolfgang, H-M. (2018). *Lehrbuch des Zollrechts der Europäischen Union. [Textbook on European Union customs law]*. (9th ed). NWB Publishing.
- Wolfgang, H-M. (2007). Emerging issues in European customs law. *World Customs Journal*, 1(1), 3–10.
- Wolfgang, H-M., & Harden, K. (2016). The new European customs law. *World Customs Journal*, 10(1), 3–16.

- Wolffgang, H-M., & Kafeero, E. (2014). Old wine in new skins: Analysis of the Trade Facilitation Agreement vis-à-vis the Revised Kyoto Convention. *World Customs Journal*, 8(2), 27–37.
- Wolffgang, H-M., & Rogmann, A. (2019). On the future of the WCO Revised Kyoto Convention. *WCO News* 88, 79.
- World Customs Organization (WCO). (1977, June 9). *International Convention on Mutual Administrative Assistance for the Prevention, Investigation and Repression of Customs Offences*. Nairobi. <http://www.wcoomd.org/-/media/wco/public/global/pdf/about-us/legal-instruments/conventions-and-agreements/nairobi/naireng1.pdf?la=en>
- World Customs Organization (WCO). (2008). *International Convention on the Simplification and Harmonization of Customs Procedures (as amended)*. Text of the Revised Kyoto Convention. WCO. [http://www.wcoomd.org/en/Topics/Facilitation/Instrument%20and%20Tools/Conventions/pf\\_revised\\_kyoto\\_conv/Kyoto\\_New](http://www.wcoomd.org/en/Topics/Facilitation/Instrument%20and%20Tools/Conventions/pf_revised_kyoto_conv/Kyoto_New)
- World Trade Organization (WTO). (1994). Agreement on Implementation of Article VII of the General Agreement on Tariffs and Trade 1994. [https://www.wto.org/english/docs\\_e/legal\\_e/20-val.pdf](https://www.wto.org/english/docs_e/legal_e/20-val.pdf)
- World Trade Organization (WTO). (2014). *Protocol Amending the Marrakesh Agreement Establishing the World Trade Organization*. <https://docs.wto.org/dol2fe/Pages/SS/directdoc.aspx?filename=q:/WT/L/940.pdf>

## Notes

- 1 For example, standards, transitional standards and recommended standards.
- 2 Cf. the binding General Annex and the nonbinding Specific Annexes of the RKC.
- 3 Cf. for this the Nairobi Convention of 1977, which has adopted this principle in its wording of the convention (WCO, 1977, p. 53).
- 4 For example, extension in time because of implementing problems, certain categories of provisions follow different timelines, recommendations and help such as technical assistance or support if a state lacks capacity to implement a provision. Note: These flexibilities are already established in the TFA.
- 5 Cf. WCO's coordinated cross border management (CBM) concept, WCO Research Paper No. 2, June 2009.
- 6 Cf. A. 'The comprehensive review of the Revised Kyoto Convention' of this article.
- 7 Cf. B. IV. 'Principles to be reflected' of this article.
- 8 Note: The information and remarks only relate to exemplary national legislations and intend to give a broad overview of the different degrees of regulations. They do not claim to be comprehensive.
- 9 Cf. Unions Customs Code (UCC), Regulation (EU) No 952/2013 of the European Parliament and of the Council of 9 October 2013 (European Union, 2013).
- 10 For more information about the customs debt system of the EU cf. for example, Lyons (2018, pp. 460 ff).
- 11 Cf. also Wolffgang and Harden (2016, pp. 6 ff.)
- 12 Customs Law of the People's Republic of China (General Administration of Customs, n.d.).
- 13 *Union of India v. A.V. Narasimhalu*, S.C.C. 658 (1 September 1969).
- 14 The Customs Act, 1962 (No. 52 of 1962) as amended up to Finance Act 2019-2020 (Act No. 23 of 2019).
- 15 *Collector of Customs Cochin v. Trivandrum Rubber Works Ltd.*, 1999 (106) E.L.T. 9 at p. 11.
- 16 W.P. No. 388 of 2005 (13 April 2005).
- 17 Australian Customs Act of 1901 (Australian Government, 2013).
- 18 *Zaps Transport (Aust) Pty Ltd*, Domenic Zappia & John Zappia (Taxation) [2017] AAT 202 (17 February 2017); File Number(s) 2016/1275, 2016/1276; 2015/5050.
- 19 *Studio Fashion (Aust) Pty Ltd* (General Administrative Decision) [2015] AATA 366 (28 May 2015); File Number 2014/2611.
- 20 Cf. Wolffgang (2007, p. 4); Witte and Wolffgang, (2018, p. 4 f); Michaelis (1981, p. 355); Lamp (1915, p. 530; 1917, p. 18).
- 21 Cf. the special procedures avoiding duties in the Specific Annexes (SA's) of the RKC such as customs warehouses and free zones (SA 'D'), transit (SA 'E'), processing (SA 'F'), temporary admission (SA 'G') or special procedures (SA 'J').
- 22 Cf. fn. 21.

- 23 Cf. B. IV. 1. 'Principles to be reflected' of this article regarding the thought and idea of the 'economic theory of customs'.
- 24 For instance, customs debt on import vs customs debt on export or customs debts in regular vs customs debts in irregular cases.
- 25 Relevant criteria in such cases could be for example the ability to pay of one customs debtor compared to another or the degree of default in case of an irregular customs debt.
- 26 The following examples refer to some of the elements and cases listed in of Art. 124 (1) UCC.

### Hans-Michael Wolffgang



Professor Dr Hans-Michael Wolffgang is Professor of Law and Director of the Institute of Customs and International Trade Law (ICTL) at the University of Münster, Germany ([www-customs.de](http://www-customs.de)). Besides his academic activities he is co-founder of the AWB Tax Consultancy and AWB Legal Services Partnership ([www.awb-international.de](http://www.awb-international.de)), which specialises in customs law, export control law, VAT law and excise tax law.

Hans-Michael Wolffgang is also a member of various advisory bodies on a voluntary basis. They include working groups of the Federal Chamber of Tax Consultants, the European Commission and the World Customs Organisation. He is the author and editor of a number of publications on customs and international trade law, including the *World Customs Journal*.

### Achim Rogmann



Professor Dr Achim Rogmann LLM is Professor of Law at the Brunswick European Law School (BELS) at Ostfalia University of Applied Sciences in Wolfenbüttel, Germany. He is also Adjunct Professor at Murdoch University School of Law in Perth, Western Australia, and advisor to different governments. Achim Rogmann has published extensively on customs and world trade law.

### Kerstin Harden



Kerstin Harden is a senior researcher at the Institute of Customs and International Trade Law (ICTL) at the University of Münster, Germany. She is a lawyer (German State Examination) and holds a bachelor's degree in Politics and Law and also graduated in Communication Science and English.



# Implementing an innovation strategy in WCO; responding to disruptive events

*Ricardo Treviño Chapa*

## Abstract

---

Innovation is how organisations develop solutions to meet new challenges. The task involves recombining existing and new elements and capabilities to serve a new objective, frequently in new and evolving contexts. While recognising and acknowledging the work done by the World Customs Organization (WCO) in setting international standards, fostering international cooperation, and delivering capacity building, this article argues that new contexts and new opportunities frequently arise from crisis scenarios. The context for international organisations has been evolving in recent years, and COVID-19 could be an accelerator of these changes. The WCO, like many other international organisations, faces new challenges in an environment of uncertainty, and the way to stay relevant is through innovation. This article proposes a set of practical tools and steps towards implementing innovation processes in the WCO that can result in the creation of value for its Members and the Secretariat.

---

## COVID-19 global impact and Customs response

COVID-19 is a health crisis that has forced governments across the world to completely shut down many productive sectors. Travel has practically ground to a halt, and trade and mobility have been deeply impacted. This is one of the worst health emergencies of our times and, although its economic impact still cannot be fully measured at the time of writing, it will be greater than that of any other previous crisis on record. Constraints and confinement measures taken by governments have been essential in slowing down the spread of the disease and in reducing the number of lives lost, but have resulted in profound economic consequences.

The scope and the duration of the COVID-19 outbreak remains unknown, but according to the Organisation for Economic Co-operation and Development (OECD 2020, p. 12) ‘The global economy is now experiencing the deepest recession since the Great Depression in the 1930s, with GDP declines of more than 20 per cent in many countries during shutdowns and a surge in unemployment’.<sup>1</sup> The World Trade Organization (WTO) forecasts world merchandise trade will decrease between 13 per cent and 32 per cent in 2020 due to the COVID-19 pandemic.<sup>2</sup>

The post-COVID-19 economy will depend on the decisions that economic actors and governments take in the months following the start of the pandemic. Maintaining trade flows as much as possible has been crucial in providing access to essential food and medical items and in limiting negative economic impacts.

Governments, business, and society have understood the importance of finding the means to continue operating throughout the pandemic and this has accelerated existing trends such as teleworking, e-commerce and automation. In the cross-border trade and customs arena this is reflected in the need

to continue the international flow of goods by strengthening global value chains, seeking paperless and automated customs systems, and promoting coordinated border management and international Customs-to-Customs cooperation.

The pandemic has not only accelerated some existing trends, it has also cast out any doubt about the importance of international cooperation and coordination as the only way to overcome a global crisis such as the one the world is currently facing. COVID-19 has shown that no country can fight alone against this crisis, giving multilateralism another opportunity to rise as the system to be pursued by governments and the way of interacting in their international relationships.

During the pandemic, many countries unilaterally opted to restrict exports of essential goods and medical supplies.<sup>3</sup> Although these measures may, in the short-term, have provided some benefits to the countries implementing them, by securing the supply of essential goods and medical equipment and thus reducing the spread of the disease, in the medium and long-term, these measures undermined the global fight against the spread of the virus.

Countries realised that, by imposing such restrictions, other countries would respond with reciprocal measures, which in the end would result in a worsening of the crisis by limiting access to essential goods. In some cases, restriction measures were imposed on imports of goods from places that were being heavily impacted by the disease, which also impacted global value chains. In the long run, key actors, and decision-makers, must make cross-border trade and the smooth flow of legal goods a priority in the strategy to combat the negative effects of the pandemic.

Global crises require global answers and, despite recent voices raising concerns about the usefulness of multilateralism, traditionally international organisations have been successful in providing appropriate platforms to shape and coordinate global actions. In the face of the COVID-19 challenge, countries, and governments again turned to international organisations to ensure a certain level of consistency and harmonisation in the approach taken towards the pandemic.

The revindication of multilateralism will not be easy; the process of opening again seems slow and is presenting more uncertainties than assurances, and economic perspectives also remain uncertain. As countries have started to get the health emergency under control, they have begun to lift their lockdowns, as we have seen initially in China and Europe, but recently we have also seen the number of new COVID-19 cases begin to increase. Restrictive policies must gradually be lifted; however, some countries will keep their international borders closed for some time trying to avoid a second wave of spread.

Moreover, the lack of tangible results in long-disputed matters within the United Nations (UN), together with criticism regarding the World Health Organization's actions during the pandemic and the recent crisis within World Trade Organization operational bodies, makes the future of multilateralism even more complex. The World Customs Organization, as part of the multilateralism system, has had, and will continue to have, a key role in providing stakeholders with post-pandemic answers.

International organisations need to *innovate* to deliver practical, functional, and tangible results. In many cases, this means that they need to reinvent themselves by introducing new strategies that allow them to provide value to their members. The WCO is no exception and needs to further increase its shift from theory to action, and from being reactive to being proactive. Crises, such as COVID-19, come with many threats, but it is our responsibility to also identify opportunities.

## WCO response to COVID-19

Throughout the crisis, international organisations played a major role in supporting and guiding governments and stakeholders. During the pandemic, the WCO took the lead and was one of the first international organisations to react to the emergency by quickly setting up a dedicated web page containing important communications and updates on COVID-19.<sup>4</sup> Among others, the WCO has published information regarding the use of related WCO tools, and has also provided a Harmonized System (HS) Classification reference document on COVID-19 medical supplies<sup>5</sup> to help countries in their fight against the spread of the virus. Members have also been asked to provide information on challenges and best practices to prevent the spread of the infection and to facilitate the flow of essential goods, and a depository of this information has been published<sup>6</sup> for the public to consult.

The WCO Secretariat immediately began liaising with the WHO to properly inform WCO Members about the situation, enabling them to be involved in national response strategies. To send coherent messages to businesses and ensure a coordinated approach to border management, close collaboration was also strengthened with other international organisations, such as the WTO, the International Maritime Organization (IMO), the International Chamber of Commerce (ICC), the International Road Union (IRU), and the Universal Postal Union (UPU), among others. This was especially highlighted by the development of a COVID-19 Trade Facilitation Repository,<sup>7</sup> together with the WTO, the United Nations Conference on Trade and Development (UNCTAD), the Commonwealth Small States Office (CSSO), the Global Alliance for Trade Facilitation (GATF), the International Air Transport Association (IATA) and the International Trade Centre (ITC), a platform that consolidates the initiatives on trade facilitation adopted by organisations and stakeholders, once again demonstrating that global challenges are better addressed through globally coordinated responses.

Collaboration with different stakeholders has been a fundamental part of the strategy followed by the WCO. Collaboration with its Private Sector Consultative Group (PSCG) has been enriching. During the pandemic, the Secretary-General and the Deputy Secretary General met with the PSCG on a weekly basis to hear and understand the private sector perspective and the impact of the different cross-border measures that had been taken, thus allowing the Secretariat to propose actions in response to these impacts.

Regardless of the global solidarity and benevolence shown in times of crisis, criminals often try to benefit from these situations. Customs administrations reported and publicised many seizures of counterfeit critical medical supplies, such as face masks and hand sanitisers. The WCO launched the Intellectual Property Rights (IPR) CENcomm Group as a means of permanent and real-time exchange of relevant information to fight these criminal activities. The customs community responded in this manner to expectations related to its essential security role, preventing suspicious and potentially harmful goods from entering the legal market.

Regarding its function to provide technical assistance, guidance, and leadership to Member administrations, the WCO is enhancing its delivery model of remote/virtual capacity-building where possible as part of a blended approach, together with face-to-face initiatives once travel is allowed.

The crisis has not yet ended, but some lessons can already be learned. Customs administrations reacted in different ways to the challenges of the pandemic. There was no single globally coordinated answer, but some of the measures implemented were successful in achieving the continuity of flows of essential goods. If there had been a more coordinated effort based on a plan devised in advance, the impact may have been smaller. A plan that considers the effective flow of essential goods through facilitation measures and exchange of information among customs administrations, together with provisions to strengthen supply chains and risk management, could be in place. Furthermore, if these trade facilitation

measures are extended beyond the COVID-19 crisis, they may have global impacts on recovery efforts. As such, the WCO should seek to maintain the political willingness and commitment of countries to implement permanent reforms.

So far, the WCO has done a great job in developing international standards, delivering capacity building, and serving as a vehicle for Customs-to-Customs cooperation; however, the context is changing. COVID-19 has accelerated this change by bringing higher levels of economic, social, and political uncertainty. Other international organisations (some with greater political influence) are turning to the customs field for opportunities to grasp benefits. Members are asking for more products and services, while resources are not increasing. Customs administrations are often not leading, or participating in, the process of developing national strategies because Customs' role lacks visibility in the higher spheres of public bureaucracies; generally speaking, societies are not familiar with customs duties and responsibilities, and customs officers are often regarded as the 'bad guys'.

Despite everything, another aspect highlighted by COVID-19 is the importance of Customs and its role in legal trade facilitation. This opens an opportunity to introduce new methods and ideas. To benefit from such opportunities, customs administrations need to strengthen their collaboration and the *WCO needs to innovate and produce additional value for its Members*.

### Reasons to innovate

As stated, crises like the one the world is facing in 2020 have a significant impact on social and economic life. This is usually in the form of disruption of several processes or paradigms that create opportunities. History suggests that organisations that invest in innovation throughout a crisis outperform peers during the recovery; Bar Am et al. (2020) observed that organisations that maintained their innovation focus throughout the 2009 financial crisis emerged stronger, outperforming the market average by more than 30 per cent, and continued to deliver accelerated growth over the subsequent years.

Through surveys and interviews, Bar Am et al. (2020) found that in many cases the natural response to the current crisis was to deprioritise innovation and concentrate more on shoring up core business, pursuing known opportunities, conserving cash and minimizing risk while waiting for times of more clarity and less uncertainty. They defined these measures as a limited response to a crisis, and highlighted other urgent actions such as:

1. adapting the core to meet shifting customer needs
2. identifying and quickly addressing new opportunities being created by the changing landscape
3. re-evaluating the innovation initiative portfolio and ensuring resources are allocated appropriately
4. building the foundation for post-crisis growth to remain competitive in the recovery period.

Businesses and institutions may not be able to continue performing as well as they have in the past by just replicating the same actions. The future we encounter may significantly differ from the present and past. This applies to international organisations as well. In the case of the WCO, shifts in Members' needs, the use of technology, other international organisations entering the 'customs market', and ever-changing political and economic contexts, among other risk factors, present new opportunities. Innovating is a move towards grasping these opportunities.

There are many definitions of innovation; it is not just a new idea, a new product or service, or a new technology. An idea itself is not innovation, rather innovation needs to be understood as a process. Usually ideas are incomplete, they need to be built upon with complementary procedures and interaction with



different social contexts. Innovation can be seen as a set of routines or procedures that an organisation carries out to create and collect aggregated value (Pisano, 2015).

It is commonly said that the number of registered patents is considered a good way to measure innovation; however, the fact of having patented a product or service does not mean it is useful. Jackson (2011) used a case study based on mousetraps to illustrate the gap between ideas and impact. The case study showed that more than 4,400 patents for better mousetraps had been awarded in the US, but less than 30 were commercially successful.

The question that needs to be asked is: why innovate? The answer is clear: the reason behind innovation is the creation of value.

According to Ventresca (2020), an organisation innovates for one of the following three reasons, or a combination of them:

1. Competition: in the case of international organisations, for a long time the prevailing approach was that there was no competition. There was an assumption that each international organisation had clear boundaries within its sector. This created a very stable environment in which international organisations could develop their business models and serve members.

It can be argued that this assumption no longer holds, creating a dynamic environment that is constantly changing and in which there are threats of new entrants to the customs arena. While the WCO is the only international organisation 100 per cent focused on customs matters, it is now facing competition from other organisations such as the World Bank, the International Monetary Fund (IMF), UNCTAD, the United Nations Office on Drugs and Crime (UNODC), the WTO, and the OECD, among others. Innovation will allow the WCO to gain the competitive advantage needed to succeed in this restless environment.

2. New business models: technology has recently become a strong source of innovation, especially by developing new business models. It is a particularly important part in most innovation processes; however, is not the only factor. Technology by itself does not create value; it must be considered together with other social interactions and external inputs. The WCO needs to reconfigure its business model to better leverage the use of technology.

The use of data analytics for risk assessment or other decision-making procedures, or the use of videoconferencing to deliver training, are just some examples of available technologies that can be better used within WCO processes.

3. New ways of creating value: the appearance of new platforms is forcing many economic actors to rethink their processes to create value. A platform is defined as a common hub that creates a new system to coordinate the way services are delivered, extracting some of this value for itself (Teece, 2017). Examples such as Amazon, Airbnb or Uber are examples of such platforms that coordinate services, provide customers with experiences, and manage relations with regulators.

The WCO could create its own platform to coordinate services provided to Members on the one hand, and to manage relations with stakeholders, such as other border agencies, on the other. A platform that orchestrates services provided by many international organisations could be another interesting initiative in the future.

Whatever the reason to innovate, the goal is to create value. What worked yesterday may no longer work tomorrow. A new idea could be the beginning of innovation but is not 'innovation'. Rather, innovation refers to the process of developing ideas, managing how to create value through these ideas, and then capturing the value created.

The WCO needs to determine how to define value from a customs perspective for its Members and for

the organisation itself. Predetermined conceptions of value can evolve over time and the development of standards, fostering of cooperation and delivery of capacity-building functions need to adapt to these changes to consistently align with the creation of value that Members are seeking. Value for the WCO should be understood as the way to assist and guide Members towards a harmonised customs environment that positively impacts in global economic development, protection of society and fair revenue collection systems.

## Innovation strategy

Historically, the world has never undergone quite so much change as it is now experiencing. There have been long periods of a stable economic context. This ecosystem has allowed international organisations to focus on exploiting their existing capabilities. Maximising the value created by their existing resources and pursuing operational efficiencies is known as ‘exploit mode’ (March (1991) and Ventresca (2020)).

With a constantly evolving environment, exploiting current resources is not a successful long-term strategy. International organisations need to identify opportunities for future success, i.e. ‘explore mode’ (March (1991) and Ventresca (2020)).

The combination of the time and resources that organisations should spend on each mode is something that needs to be discussed and agreed with Members. How much of our present efforts should be directed towards obtaining current value, and how much should be focused on identifying and planning for new sources of value? The resulting equilibrium is called the ‘exploit-explore ratio’, as illustrated in Figure 1.

Figure 1: The exploit-explore ratio at any point in time

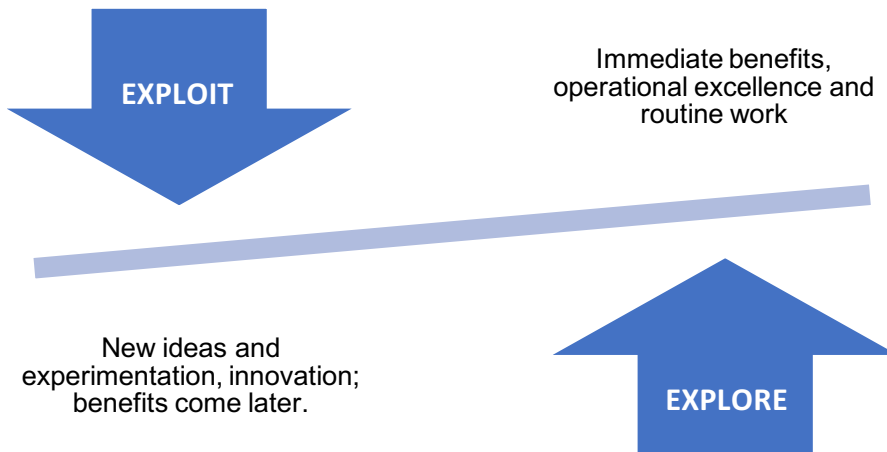

Source: Adapted from The Oxford Strategic Innovation Programme (Ventresca, 2020)

In the case of the WCO, the current Strategic Plan 2019–2022 presents a complete shift from the previous versions in how the WCO is carrying out its processes.<sup>8</sup> With the application of the Balanced Scorecard Methodology, the identification of strategic processes within one of the strategy’s dimensions acknowledges the importance given to the exploit mode as shown in Figure 2.

Figure 2: The WCO's strategic map 2019–2022

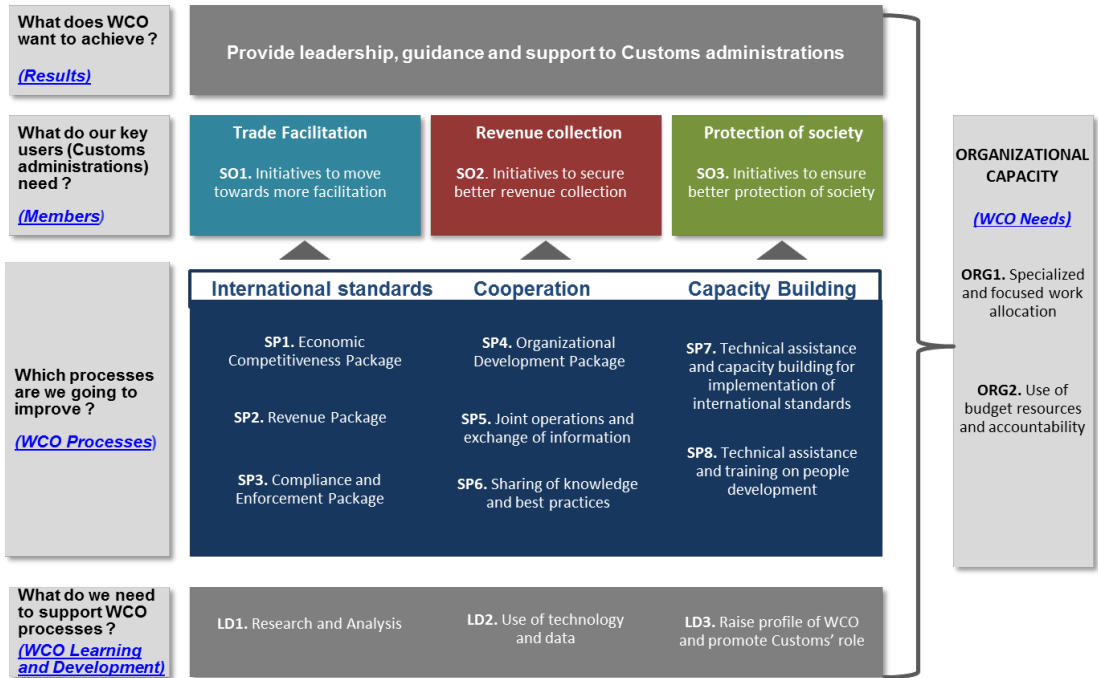

Source: World Customs Organization 2019, *Strategic Plan 2019–2022*.<sup>9</sup>

## The WCO's strategic map 2019–2022

At the same time, the WCO's Strategic Map takes into consideration the 'explore mode' when talking about organisational needs to be developed to improve such processes.

To engage in the explore mode, existing processes need to be discarded and new processes need to be put in place (Pisano, 2015). The new procedures must give room to developing ideas and opportunities. This needs to be embedded in the core of the organisation, together with a culture that embraces risk-taking with a purpose. Although a new and more inclusive process was implemented through the realisation of six regional consultations, the WCO's Strategic Plan still needs to be aligned with the environmental scan and appropriate action plans. There is clarity in the Internal Processes perspective, which would mean that the exploit mode is being prioritised (this is in line with the Strategic Plan cost allocation), but concrete actions and processes need to be implemented to ensure the objectives in the Learning and Development (L&D) perspective are met.

During these consultations, Members decided to place the use of technology, the need for research and analysis, and raising the profile of the WCO and promoting Customs' role, in the L&D perspective, which means these are the areas in which the WCO needs to put in place new processes and invest resources in line with the explore mode.

An important change in WCO Strategic Planning is the introduction of managing it as a continuous process. This is relevant because Members and the Secretariat need to understand that it is natural to have a strategy that is evolving, considering internal or external changes. Throughout the current crisis this has been clearer than ever since priorities are changing, the context is constantly changing, and the way of approaching different challenges is also changing. The WCO's Strategic Planning Cycle

provides the much-needed flexibility for the strategy and, together with the new monitoring tool on the implementation of the Strategic Plan,<sup>10</sup> creates enough space to adapt the strategy (Figure 3). This flexibility is also key in developing an innovation culture within the organization.

Figure 3: Strategic planning cycle



Source: World Customs Organization 2019, *Strategic Plan 2019–2022*.<sup>11</sup>

The ‘explore mode’ needs to implement innovation processes that focus on trying to identify new opportunities to create value by developing the use of new technologies, drawing up new research papers and analysis, and creating new ways of promoting the role of Customs. All these will occur in a new dynamic post-COVID-19 context which will demand a different and specific set of skills and organisational capabilities.

The aim is to reach the right balance between the ‘exploit’ and ‘explore’ modes and to create enough value today by perfecting the operation of the organisation, but to also have enough resources to devote to experimenting with new ideas and developing services that create value in emerging trends. This could be achieved by a better linkage between the Strategic Plan and the WCO’s Environmental Scan.<sup>12</sup>

Junni et al. (2015) propose a mix of structure and culture within an organisation to build capacity for innovation. They present a framework that organisations can use to balance their exploit-explore ratio considering three main categories:

1. Human resource management. Human resource practices should support the organisation’s capability to do both: exploit and explore. Policies should be in place to motivate staff to pursue innovative behaviours and management to promote leadership by measuring their performance associated with innovative practices.
2. Organisational structure. The structure of the organisation needs to facilitate the exploit and explore activities in the right way by separating its different units according to their goals and functions.
3. The organisation’s culture should promote shared values and sustain social networks to enable collaboration and exploration tasks.

In the first category, the WCO needs to work on a solid human resources policy. A range of processes needs to be underscored so that talent, attention and expertise can be shaped adequately through standardised hiring and selection processes, a well-established reward system, coherent, updated and clear job designs, and the arrangement of teams with complementary skills.

In the structural category, the WCO's structure needs to define which activities are linked and how information should flow between the different units, who makes decisions and on what terms, and who is accountable to whom and in what manner. Evidence suggests that features such as collaboration, decentralised decision-making and intrinsic incentive schemes are key in promoting innovation.

Changing an organisation's structure or processes alone will not change how people interact within it or how different routines can be linked. This requires a deep change in the culture of the organisation. Culture needs to reinforce the commitment to experimenting, exploring and learning new ways of doing things. Features such as failure tolerance, experimentation, open communication and non-hierarchical or flat structures often promote innovative cultures.

## **Types of innovation**

Organisations are established in a way that allows them to do what they excel at. Best practices and the routines that accompany them form part of an organisation's structure and strategy. In other words, organisations are built around routines, and these routines are built into sets of tasks and activities that are difficult to change. Usually, innovation goes against these existing successful routines.

Innovation is built upon procedures and routines which fit best within the strategy of the organisation. Depending on the type of innovation that the organisation is seeking, changes and adjustments need to be made to the strategy. Teece (1986) summarises the types of innovation as:

1. **Product and service innovation:** this is the most common type of innovation. Usually it is about exploiting current capabilities or procedures by increasing the volume of production or finding cost efficiencies. This type of innovation usually produces an immediate and short-lived impact and is better implemented when markets and ecosystems are stable.
2. **Business model innovation:** this type of innovation has become more frequent since the launch of the Internet. It focuses on creating new activities, creating a link between existing activities, or changing areas that perform certain tasks with the purpose of outperforming competitors. The creation of digital platforms is currently a common tool of business model innovation.
3. **System-level innovation:** this type of innovation considers a broader sectorial or societal reordering. It usually starts in an individual process and in how it interacts with other processes, or in other words, a part of the system that influences other parts of the system.

An example of innovation for the WCO at the product-service level would be to find efficiencies in the process of developing standards and guidelines or including a new component that could add value for Members when delivering capacity building or technical assistance. This would be in line with exploiting the current resources and capabilities through operational efficiencies.

As a business model innovation, the WCO could explore new ways of doing things and creating additional value in its current deliverables. An example that could help illustrate this is migrating from the current traditional face-to-face method of delivering capacity building to online delivery. This uses the opportunities created by the available technology in the market. Online meetings and the use of videoconferencing solutions is another way to innovate at the business model level and is something that has been implemented due to COVID-19. A platform to share information that results in value to Members is another way of innovating.

Regarding system-level innovation, the WCO could think of an innovative process that disrupts the environment in which international organisations operate. This could involve creating value in new ways not seen before, for instance, by implementing specific activities to assist Members, or carrying out actions that will impact the system in which customs administrations work.

Systemic innovation might better enable a consistent impact but usually is regarded as a more radical change and faces stronger cultural resistance; however, it can be obtained as a result of other innovations at the product or service and/ or business model levels that can work as enablers. Moving innovation from one type to another could be regarded as more of a linear progression than a radical change, smoothing the organisation's adaptation process.

### Organising for innovation

Innovation does not just happen; it is something an organisation must work for. Innovation is complex and needs to be placed at the core of an organisation, together with processes that structure and encourage it.

De Jong et al. (2015) performed a multi-year study comprising interviews, workshops and surveys involving over 2,500 executives and more than 300 companies in a broad set of sectors and countries, and found that eight essential attributes were present, fully or partially, in every case that presented a higher performance due to innovation. They summarised these eight attributes as follows:

1. **Aspire.** Accept innovation to grow or stay relevant and establish targets to reflect this.
2. **Choose.** Invest enough time and resources in a measured risk portfolio of initiatives.
3. **Discover.** Find insights into what matters to stakeholders and understand the impact of these changing needs. This attribute could also be called 'rediscover' since the environment is frequently changing.
4. **Evolve.** Create robust and scalable new business models that provide sustainability and resilience to the organisation.
5. **Accelerate.** Outperform competition with faster and more effective ways of identifying, implementing, and capturing value.
6. **Scale.** Launch innovations in relevant ways to stakeholders, in the right volume and at the right time.
7. **Extend.** Create and capitalise on alliances and partnerships. Create new external networks that provide additional value to the organisation's outcomes.
8. **Mobilise.** People within the organisation must be motivated, compensated and organised to innovate repeatedly.

The study shows that a comprehensive system or set of routines based on these eight essential attributes has a strong positive correlation between innovation performance and economic performance. Mastering at least five out of these eight attributes already demonstrates this result, which is improved even more when at least seven attributes are implemented.

An assessment of these attributes within the WCO reveals the following, as outlined in Figure 4.

Figure 4: Assessing the attributes within the context of the WCO

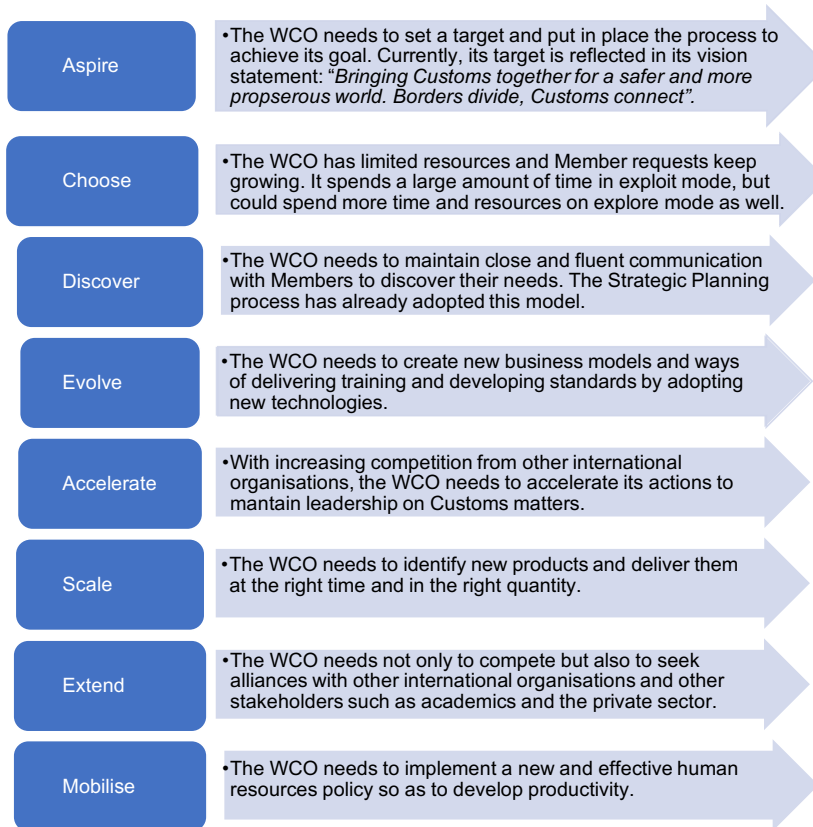

The ways in which organisations structure and allocate their activities and resources are important when they are striving to innovate. It is not uncommon to see innovation run counter to an organisation's successful practices. As we saw before, it is desirable to find a balance in the exploit-explore modes to be successful. Tushman et al. (1996) define this balance as organisational ambidexterity which is defined as the ability to simultaneously pursue both incremental and discontinuous innovation, hosting multiple contradictory structures, processes, and cultures within the same organisation.

Meyer (2014) presents an extensive literature review on the matter and proposes to analyse four levels that help measure an organisation's capacity to create and innovate: Organisation, Management, Staff, and Environment (OMSE). I will refer to these four levels as the OMSE framework which can be used as a toolkit to build capacity for innovation. The four levels of the OMSE can then be associated with 110 main categories and can help examine its components and interactions in relation to innovation and can help assess the eight essential attributes mentioned above. At the four-level dimension, the OMSE framework refers to the following:

- Organisation: this refers to how the strategy and plans are formulated to pursue innovation. The goals established in the mission and vision statements as well as other overriding factors such as convictions and values.

- **Management:** This refers to the structure of the organisation and the capabilities that this arrangement provides. Processes and activities interact to encourage the innovation process; specific processes that help generate ideas, develop them, assess them, and implement them in a way that expands their value. The type of leadership and management that allows for creativity and the granting of resources.
- **Staff:** this considers people's diversity and inclusion. It incorporates the different roles and backgrounds of employees. This is directly impacted by the organisation's recruitment and selection policy, as well as the way people are managed.
- **Environment:** this refers to the organisation's culture and its shared values and social norms within the organisation. It refers to how communication is promoted, the risk-taking culture and how the climate in the work environment is perceived.

The way in which these four elements are designed and reinforce each other enables an organisation to build its capacity to innovate. Applying the OMSE framework to optimise the way the WCO approaches these elements is another way of helping identify actions that can lead to innovation (Figure 5).

Figure 5: OMSE Framework applied to the WCO

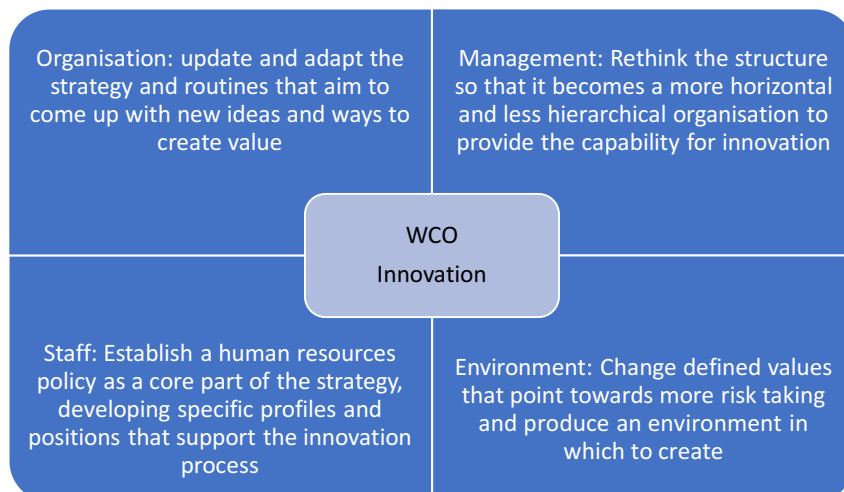

## The innovation process

There are different ways of organising for innovation, taking as a basis the OMSE framework and the eight essential attributes. The way an organisation structures its processes and resources might impact on innovation, by either promoting and supporting it, or blocking it.

A decision needs to be taken on how to shape the innovation process, and how to merge it with the ongoing activities and existing resources. This decision needs to be reflected in the Strategic Plan.

An innovation strategy should determine what types of innovation should be pursued. It should also align activities in relation to core innovation goals and the key competitive advantage that the company is trying to gain. A vital element in this strategy is the relationship between creating and capturing new value.



Value creation can be defined as the degree to which final users believe they have gained value from a product or service. Value capture refers to the reward or profit that the organisation gets back from the final user (Verdin & Tackx, 2015). In other words, the more the WCO provides value to its Members, the more they will trust and engage with the organisation.

Well-established organisations can capture value for a long period without being innovative or creating new value because they have been leaders in a specific market and have been maximising their operational resources. However, in a dynamic and unsettled environment, such as a post-crisis situation, competition increases, and this value is almost certainly impacted negatively. As a result, organisations face a scenario that requires a deep strategic transformation towards innovation and value creation.

When the external context changes, the products or services provided by an organisation may no longer be relevant. For a long-term solution, organisations need to find ways to innovate and sustainably create value. Despite the desire to find new ways of creating values, many institutions fail. Besides following and aligning the right elements in the organisation (based on the OMSE framework or the eight essential attributes presented before), according to Pisano (2015) leadership needs to also consider:

1. What type of value from innovation is being pursued? This could be either economic or social benefit, for instance.
2. How will value be captured from innovation? What will be the competitive advantage that could differentiate the organisation from the rest?
3. What kind of innovation will create and capture value: product or service, business model or systems innovation?
4. How should resources be allocated to the different goals identified?

The answer to these questions needs to come from the strategy. One way to approach these dilemmas is to use the innovation strategy map (Table 1) which categorises innovation in the following three areas (Pisano, 2015):

1. degree of innovation (routine or radical)
2. locus of innovation (component or architectural)
3. source of value (core innovation or complementary assets).

Table 1: The WCO current innovation strategy map

<b>WCO current innovation strategy map</b>	
<b>Degree of Innovation</b>	Currently more focused on routine innovations. Working groups are trying to find improvements in existing products, for example RKC <sup>13</sup> Comprehensive Review, HS Review and SAFE Framework of Standards update, among others.
<b>Locus of Innovation</b>	We can find more innovation in components or parts of the process delivered by the WCO than in architectural matters. Discussion is starting on updating rules of procedure and other governance issues, but it appears difficult to make radical changes to founding instruments.
<b>Source of Innovation</b>	Lately more focused on complementary assets, for example, the WCO has been directing efforts towards complementing the implementation and use of the WTO's TFA. <sup>14</sup>

An organisation can find a balance between each of these categories. The WCO is not necessarily always focused on routine, component, and complementary innovation; at certain times and in certain processes it can interact as well with radical, architectural and core innovation. However, the above analysis currently seems to be the most representative one.

This is no surprise since the priorities established by the Members in the 2019–2022 Strategic Plan reflect the organisation’s current routines, processes, and tasks.

Any change to the strategy would require the WCO to reconfigure the roles, business systems and relationships that value creation is based on. The challenge lies in how to align the innovation strategy with the elements of the OMSE Framework and how to organise value-creation activities in ways to support such a strategy.

This challenge can be addressed by implementing the innovation value chain. In common strategy-based perspectives, the competitive advantage of any organisation is conceptualised under the value-chain model. The main imperative is to make sure that the organisation is delivering value at the correct process along the chain. Hansen and Birkinshaw (2007) introduce the innovation value chain to align innovation with the strategy by introducing the concepts of value creation and value capture.

The innovation value chain is inspired by the traditional strategy-based concept of value chains. The traditional value chain divides the activities of an institution into support activities (research, human resources, technology and other) and primary activities (those directly involved in the physical development and distribution of a product or service such as operations, logistics, sales, and other). Both sets of activities produce value and should be organised in a way that optimises competitive advantage (Porter, 2001, pp. 50–66).

As mentioned, an innovative organisation is not just one that has good ideas or invents new things. An innovative organisation is one with the capacity to create and capture new value, and this requires alignment between the organisation’s innovation strategy and its innovation process or innovation value chain.

The innovation value chain requires organisations to meet the dual strategic imperatives of value creation and value capture by describing three integrated processes in innovation:

1. generating new ideas
2. converting good ideas into value-generating outcomes (value creation)
3. deriving benefits from new products or services, business models or systems (value capture).

These three processes are separate but interdependent. If they do not recognise this interconnection, organisations may never capture the full value or impact of innovation. To establish an innovation value chain, the WCO could follow the steps illustrated in Figure 6.

Figure 6: Steps towards an innovation value chain

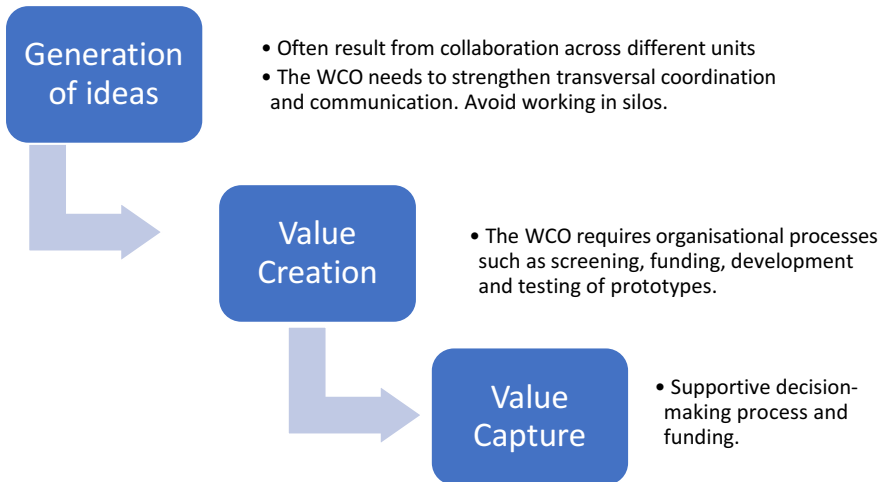

Source: Created by the author and adapted from Hansen and Birkinshaw (2007)

Leadership commitment and understanding of the innovation cycle is vital in all three stages. In terms of organisational structure, a division of labour that is set up for the work that the WCO has historically done is not necessarily going to be effective in moving new ideas through the value chain to facilitate innovation in the organisation under the new conditions following COVID-19.

The design of the division of labour needs to allow the WCO to innovate consistently and routinely. It should reflect the strategic imperatives of the organisation and could even be based on a distributed regional system.

The organisation should be open to discussing old ideas and connecting them with new ways, places, and combinations to implement them. All these activities must be framed under an innovation system that enables the practical implementation of a strategically aligned innovation value chain. The system must be understood as a set of processes and structures that prescribe how the WCO searches for ideas and creates and captures value.

## Implementation of innovation

Introducing innovation and change can be incredibly tough, but it can also be equally rewarding in bringing together like-minded people and turning today's ideas into tomorrow's reality.

Different models exist to implement or operationalise an innovation strategy and innovation value chain. Three approaches can be assessed to determine which one would be the more suitable for the WCO depending on its Members' decision: Stage-Gate Systems, Agile Models, and Open Innovation Models, as follows:

1. **Stage-Gate Systems:** these divide the innovation process into different work tasks, from idea generation to implementation and post-implementation (Cooper, 1990). Stage-Gate Systems divide the process into stages, and each stage is more costly, risky, and resource-intensive than the previous one. In this type of system, each work stage is followed by a 'gate' or quality control activity. At each stage, a certain component of innovative work is added and at each gate a review is performed. If this is not passed, the next stage cannot start.

2. Agile Model: essentially, this is a more flexible, iterative, and interactive process that follows six steps (Rigby et al., 2016):
  - a. A small, cross-functional, and self-managed team is created with a team leader
  - b. The team develops ideas and leadership ranks in terms of financial feasibility and value to stakeholders
  - c. The team breaks up the top-priority tasks and works on these over short periods of time
  - d. The team convenes daily to resolve problems and report progress
  - e. Products are tested, feedback is implemented immediately
  - f. Once each priority is complete, the next one is tackled.
3. Open Innovation: this method represents a shift away from the traditionally closed and closely guarded innovation process. It involves a transfer of expertise, skills, and knowledge beyond the organisation itself (Chesbrough, 2003).

Some of the implications and conditions that need to be considered when deciding the approach to take towards implementing the innovation value chain are shown in Table 2.

*Table 2: Implications and conditions to consider when implementing innovation*

<b>Approach</b>	<b>Implications</b>	<b>Strength</b>	<b>Weakness</b>
<b>Stage-Gate Systems</b>	Organisation is divided into project teams and senior managers are required to act as gatekeepers for all projects.	A rational approach based on incremental improvements and evidence-based decision-making. Minimises risk. Useful in incremental or component innovation.	Useful in predictable innovation scenarios, not for coping with uncertainty and the current fast-paced conditions. Not much flexibility.
<b>Agile Model</b>	Cross-functional team totally dedicated to the innovation process. Strong leadership with an understanding of the innovation process is needed.	Allows creativity and responses to new information. Accelerates the process of innovation by performing tests after each short sprint. Works best for complex problems in turbulent environments.	A very self-directed process which limits the participation of people outside the small group. External context is not always considered. Needs frequent testing of improvement, access to final users.
<b>Open Innovation</b>	Develop capabilities to engage with external information and sources of insight. Collaborate with external people and other institutions.	Takes into consideration the external context and can base its core work on independent research units. When a trend or threat is poorly understood by the internal structures, this approach allows organisations to notice signs of forthcoming changes.	Could involve more complex governance arrangements such as joint ventures, Memorandum of Understanding (MoU) or other type of agreement that can make the process slow and limited.

To consider which type of innovation approach is better for the WCO, the WCO Council would need to discuss in detail each approach's strengths and weaknesses, and the organisational implications. Each of these alternatives requires organisational reforms and has funding implications that need to be analysed.

## Drivers of innovation

Innovation is a complex process, driven by different influences and sources. Several models are used to determine what drives innovation in an organisation.

Innovation is commonly linked with technology solutions, but it can also be driven by several other different factors. According to Schumpeter (1942) innovation leads to gales of 'creative destruction', as innovation causes incumbent ways of doing things (supply chains, governance forms, technologies of capabilities) to become obsolete and supplants them with new ways, developments, capabilities and structures. This model works at a broad level where new technologies and associated complementary activities create and destroy existing structures.

According to Geroski (2003), the supply of innovative offerings drives the evolution of new markets. He argues that supply drives new markets and that demand is initially inchoate or without a form; hence, demand in new markets awaits a dominant design with specific features and attributes. This is known as the supply-push innovation model.

Geroski (2003) also introduces the demand-pull model. This model begins with the assumption of demand from existing customers. In this case, final users can specify demand beyond their current experience of a product or service offering and thus play an important role in driving innovation.

As mentioned before, technology is another common driver of innovation. A way of understanding the dynamics of technology that shape innovation is through S-curves (Foster, 1986). Tushman et al. (1996) state that there is a pattern that describes evolution of innovation and organisational growth. S-curves can be used to describe this pattern as the performance of an innovation or a technology over time combined with Anderson and Tushman's (1990) four eras: Discontinuity, Ferment, Dominant Design, and Incremental Improvement. Basically, the four eras suggest that when a new technology or innovation emerges, there is a period of ferment which is mainly characterised by low performance and limited access. After this, a dominant design emerges which is followed by incremental changes that improve its attributes and efficiencies. Finally, a new product arises which produces an era of discontinuity and starts the cycle again. This trend can be reflected in an S-curve (Figure 7).

Figure 7: Performance over time of an established product compared to a new one

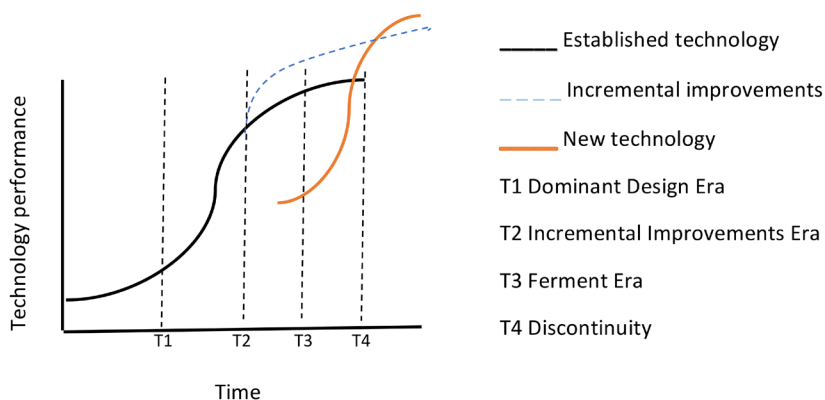

Source: Created by the author and adapted from Anderson and Tushman (1990)

Figure 7 shows how, if an established product or service remains in a state of exploit mode (incremental improvements), a new entrant will eventually overtake its performance space. However, if the established product or service focuses on the explore mode, it is possible to outperform the new entrant.

It is important to consider that, while technology can have an important role in innovation, innovation itself does not rely on technological advances. Disruption too often overvalues the role of technology; however, technology alone cannot achieve anything. Technology provides opportunities which can have an impact depending on how they are used, and on the building of sociotechnical systems.

Another common driver of innovation is the final user. The user-driven innovation model is also a recent approach. This model puts the end user at the centre of innovation. The process of designing and creating new services and products starts from a clear understanding of the user's needs. In this model it is important to put in place mechanisms that help the organisation predict what the end user will need in the future.

The WCO could take a combined approach. Since its relationship with final users (Members) is close, they need to be placed at the centre of innovation processes. Members are usually engaged during the whole process of developing standards or creating new structures so they can heavily influence the process in both the supply-push and the demand-pull models. On the other hand, the Secretariat also has a privileged perspective on matters around the world, and its staff is usually extremely prepared to engage in innovation processes independently.

The use of technology is key in an innovation process in which the WCO might engage in the future; however, this is not the only component of innovation. Value from innovation is created by combining organisational competencies, technologies, and Member inputs. The WCO's Single Window tool is a clear example of a well-established platform that creates value to Members and gives customs administrations a leading role when implemented and it is now in many countries going through incremental changes. According to the performance over time of an established product, the Single Window might soon face the threat of new entrants; thus, Members and the Secretariat need to work together to create a new ecosystem to improve the WCO's creation and capture of value.

## Leadership and innovation

As stated before, for innovation to be successful and part of the core functions of an organisation, leadership must strongly support and understand the process. Leadership is not only found in top management; it is also found in other groups and possibly in the culture of the organisation itself.

According to Bolman and Deal (2017), there are three ways in which we can conceptualise organisations and the way they work. These are linked to the way they implement leadership and the way innovation can be engaged. The three main concepts are:

1. Structural or design view. The key is to design the right practices and processes in a routine. It works almost automatically, and the results of innovation are trusted in this way of performing. It is based on rationality and practice.
2. Contested arenas. These are organisations with certain unwritten rules, where resources and relationships are a key factor of leadership. This is a more political model that considers groups of people and coalitions that can agree or disagree in many matters but in the end are productive.
3. Cultural view. Organisations are places where meaning is made, where people perceive and make sense of things. Identity, roles, and organisational culture are key factors to consider.

These three views can provide important insights to help determine an action plan that considers critical activities to get things done and to implement innovation in the WCO.

The design view can provide insights into how the hierarchy is working and the nature of the decision process. This is the most common way to look at an organisation.

Contested arenas add to the classic design view. In terms of a contested arenas view, it would be helpful to determine: who is the dominant coalition? What are the key resources? How are internal conflicts being solved in a regular way?

Finally, if we take the third view, in cultural terms we should determine what the dominant meanings are within the organisation. How do we interpret things and what is the nature of the organisation: 'We are all customs officers, so we think in terms of Customs.' This is the dominant logic of the view of how we do things in the WCO, and it is important to understand it. It is important to consider that across Members we can find differentiated customs functions, spanning from security to facilitation of trade-focused approaches. These differences might orient the organisation's culture and shed light on the way people interpret their role as well as the type of leadership needed to carry out innovation strategies.

For each of these views, Bolman and Deal (2017) state that a characteristic set of leadership and managerial skills is needed, as shown in Table 3:

*Table 3: The type of leadership needed in different concepts of organisations*

<b>Concept of organisation</b>	<b>Type of leadership</b>
<b>Structural or Design</b>	Leaders are the architect. The leadership builds the infrastructure, creates rules, determines hierarchy, and evaluates the decision process.
<b>Contested arenas</b>	Leaders are basically brokers. The leadership works among people and different coalitions, builds new coalitions, and negotiates ideas. The leadership works out the rules of the game and changes them when necessary.
<b>Cultural</b>	Leaders have a more inspirational role. A leader is considered a wise person, someone who stands between the everyday tasks of the organisation and the wider, transcendent values.

## Conclusion

The COVID-19 crisis is challenging the world. Governments and international organisations are no exception. The WCO has a clear mandate to assist, guide and provide leadership and, as part of this multilateral system, needs to find new ways of serving its Members.

Customs has been at the forefront of the response of governments to this crisis. Supporting global value chains by securing the flow of essential goods, while fighting and detecting illegal operations, has been fundamental in overcoming the crisis. The WCO has been at the forefront of this effort and has provided its Members and the global community with relevant information and a set of best practices and recommendations that have helped relieve the impact of the pandemic.

Nevertheless, there is more that can be done, and the future is uncertain. The 'new normal' is still to be defined and the WCO not only needs to adapt to the new reality but, in some cases, needs to lead it. One way of doing this is by implementing an innovation strategy.

There are many challenges ahead of us: as explained, organisations set routines to repeat what they do best, and changing these processes is costly and time-consuming. This confronts us with the challenge of overcoming inertia, to convince employees and Members that a new way can be established.

How can we inject the organisation with sufficient innovation to add value for customs administrations?

This paper follows a methodical approach to innovation in the WCO that should start with the definition of the next 2022–2025 Environmental Scan and Strategic Plan.

The strategy must answer why we want to innovate and how we want to focus our resources to reach the proper balance between the exploit and explore ratio.

The strategy needs to determine within its priorities what type of innovation we want to pursue: service, business model or system? It also needs to perform an assessment of the capabilities we currently have and what we are lacking, and to establish concrete actions to acquire them if needed. By using the OMSE framework, we can align the structure of the organisation to the desired objectives set out in the strategy.

The Strategic Plan 2022–2025 needs to be better linked with the Environmental Scan to better identify current trends, opportunities, and threats, and establish concrete actions with concrete deliverables for customs administrations. In other words, the Strategic Plan should not only consider how we can be better in what we are currently doing, but also establish a clear innovation strategy map which identifies the degree, locus, and source of innovation. Members and the Secretariat need to follow a coordinated planning approach which considers innovation strategies that can help in crisis management and business continuity scenarios.

Once the Strategic Plan has been agreed by WCO Members, through the consultation process, an innovation value chain needs to be put in place. This innovation value chain should seek to generate good ideas, create value for Members through the implementation of these ideas, and capture value for the WCO itself through more engagement and trust from its Members.

The innovation value chain must be implemented through either a stage-gate system, an agile model, or an open innovation model. Potentially, this requires discussion of an internal reform and the reallocation of working areas to achieve more transversal collaboration and to avoid working in silos.

Discussion is needed of how the Secretariat's unilateral efforts can be incorporated, together with Members' synergies and contributions from other stakeholders. Engagement with stakeholders can be a central part of the strategy towards a more cooperative one. This approach might help overcome the risk of falling into a competition logic and instead finding strategic alliances that can help WCO differentiate and become more visible. Leadership throughout the process is important and a specific set of skills will be truly relevant for the process to succeed.

The ultimate reason for innovating is to create new forms of value. Some initial ideas of how to create value that could be adopted by the WCO are to:

- a) engage, adopt, and recombine technologies and procedures
- b) strengthen Member engagement through communication, coordination, and inclusiveness
- c) seek alliances or partnerships with other international organisations
- d) connect and experiment with other stakeholders
- e) engage and promote regulatory change.

Value is created only when ideas are implemented, and the outcomes of innovation are measurable. New sources and concepts of value arise frequently, for instance, millennials and Generation Z consider concepts such as environmental matters, cyber security, and happiness to be higher priorities than they were for previous generations. A strategy that places people and employees in the centre, seeking sustainability linked to the UN's Sustainable Development Goals could be attempted. The WCO needs to anticipate these trends and start a process of adopting these new forms of value at the same time as it engages in current global discussions.



The use of IT solutions is common in innovation processes. Digital economies are transforming life through better services, and by solving structural problems. By digitising services, governments can meet public expectations and become more efficient. The WCO can foster automation and the modernisation of customs procedures using new technologies. Many other international organisations may also be thinking this. In this competitive environment, the usual process of collecting best practices and developing guidelines could work, but will this work model be sustainable? Is the WCO ready to compete with other international organisations that have greater political influence? The answer is probably not for long. The customs community is facing challenging times and, to overcome them, we need to innovate and raise Customs' awareness by keeping the WCO relevant.

## References

- Anderson, P., & Tushman, M. (1990). Technological discontinuities and dominant designs: a cyclical model of technological change. *Administrative Science Quarterly*, 35(4), 604–635.
- Bar Am, J., Furstenthal, L., Jorge, F., & Roth, E. (2020). *Innovation in a crisis: Why it is more critical than ever*. McKinsey Insights. <https://www.mckinsey.com/business-functions/strategy-and-corporate-finance/our-insights/innovation-in-a-crisis-why-it-is-more-critical-than-ever?cid=eml-app>
- Bolman, L.G., & Deal, T.E. (2017). *Reframing organisations: artistry, choice, and leadership* (6th ed.). Jossey-Bass.
- Chesbrough, H.W. (2003). *Open innovation: the new imperative for creating and profiting from technology*. Harvard Business School Press.
- Cooper, R.G. (1990). Stage-Gate systems: a new tool for managing new products. *Business Horizons*, 33(3), 44–54.
- Corbett, A. (2018, June 26). The myth of the intrapreneur. *Harvard Business Review*. <https://hbr.org/2018/06/the-myth-of-the-intrapreneur>
- De Jong, M., Marston, N., & Roth, E. (2015). *The eight essentials of innovation*. McKinsey Quarterly. [online] McKinsey & Company. <https://www.mckinsey.com/business-functions/strategy-and-corporate-finance/our-insights/the-eight-essentials-of-innovation>
- Foster, R.N. (1986). Working the S-curve: assessing technological threats. *Research Management*, 29(4), 17–20. <https://doi.org/10.1080/00345334.1986.11756976>
- Geroski, P. (2003). *The evolution of new markets*. Oxford University Press.
- Hansen, M.T., & Birkinshaw, J. (2007, June). The innovation value chain. *Harvard Business Review*.
- Jackson, N. (2011). *Mousetraps: a symbol of the American entrepreneurial spirit*. The Atlantic. <https://www.theatlantic.com/technology/archive/2011/03/mousetraps-a-symbol-of-the-american-entrepreneurial-spirit/70573/>
- Junni, P., Sarala, R. M., Tarba, S. Y., Liu, Y. & Cooper, C. L. (2015). Guest editors' introduction: the role of human resources and organisational factors in ambidexterity. *Human Resource Management*, 54(1), 1–28.
- March, J.G. (1991). Exploration and exploitation in organisational learning. *Organisation Science*, 2(1), 71–87.
- Meyer, J. U. (2014). Strengthening Innovation Capacity through Different Types of Innovation Cultures. *Technology Innovation Management Review*, 4(12), 6–16. <http://doi.org/10.22215/timreview/853>
- Organisation for Economic Co-operation and Development (2020), *OECD Economic Outlook*, Volume 2020, Issue 1, OECD Publishing, Paris. <https://doi.org/10.1787/0d1d1e2e-en>
- Pisano, G.P. (2015, June). You need an innovation strategy. *Harvard Business Review*.

- Porter, M. (2001). The value chain and competitive advantage. In D. Barnes (Ed.), *Understanding business processes*. Routledge.
- Rigby, D., Berez, S., Caimi, G., & Noble, A. (2016). *Agile innovation*. <https://www.bain.com/insights/agile-innovation/>
- Schumpeter, J. (1942). *Capitalism, Socialism, and Democracy*. Harper & Bros.
- Teece, D.J. (1986). Profiting from technological innovation: implications for integration, collaboration, licensing and public policy. *Research Policy*, 15(6), 285–305.
- Teece, D.J. (2017.) Dynamic capabilities and (digital) platform lifecycles. *Advances in Strategic Management*, 37, 211–255.
- Tushman, M.L., & O'Reilly, C.A. (1996). Ambidextrous Organizations: Managing Evolutionary and Revolutionary Change. *California Management Review*, 38(4), 8–30.
- Tushman, M.L., Lakhani, K.R., & Lifshitz-Assaf, H. (2012). Open innovation and organisation design. *Journal of Organization Design*, 1(1), 24–27.
- Tushman, M.L., & O'Reilly, C.A. (2013.) Organizational ambidexterity: past, present, and future. *Academy of Management Perspectives* 27(4), 324–338.
- Ventresca, M. (2020). *Lecture Notes: Oxford Strategic Innovation Programme*. Saïd Business School, University of Oxford.
- Verdin, P., & Tackx, K. (2015). *Are you creating or capturing value? A dynamic framework for sustainable strategy* (M-RCBG Associate Working Paper Series No. 36). Harvard Kennedy School.
- World Customs Organization (WCO). (2019). *Strategic Plan 2019–2022*. <http://www.wcoomd.org/-/media/wco/public/global/pdf/about-us/administrative-documents/wco-strategic-plan-2019-2022.pdf?db=web>
- World Customs Organization (WCO). (2020) *COVID-19 – WCO Updates*. <http://www.wcoomd.org/en/topics/facilitation/activities-and-programmes/natural-disaster/coronavirus.aspx>
- World Trade Organization (WTO). (2020, April 8). *Trade Statistics and Outlook: Trade set to plunge as COVID-19 pandemic upends global economy* [Press Release 855]. [http://www.wto.org/english/news\\_e/pres20\\_e/pr855\\_e.htm](http://www.wto.org/english/news_e/pres20_e/pr855_e.htm)

## Notes

- 1 OECD (2020). OECD Economic Outlook. Volume 2020 Issue 1. OECD Publishing: Paris, p. 12.
- 2 [www.wto.org/english/news\\_e/pres20\\_e/pr855\\_e.htm](http://www.wto.org/english/news_e/pres20_e/pr855_e.htm)
- 3 [www.wcoomd.org/en/topics/facilitation/activities-and-programmes/natural-disaster/list-of-countries-coronavirus.aspx](http://www.wcoomd.org/en/topics/facilitation/activities-and-programmes/natural-disaster/list-of-countries-coronavirus.aspx)
- 4 [www.wcoomd.org/en/topics/facilitation/activities-and-programmes/natural-disaster/coronavirus.aspx](http://www.wcoomd.org/en/topics/facilitation/activities-and-programmes/natural-disaster/coronavirus.aspx)
- 5 [http://www.wcoomd.org/-/media/wco/public/global/pdf/topics/nomenclature/covid\\_19/hs-classification-reference\\_edition-3\\_en.pdf?la=en](http://www.wcoomd.org/-/media/wco/public/global/pdf/topics/nomenclature/covid_19/hs-classification-reference_edition-3_en.pdf?la=en)
- 6 [http://www.wcoomd.org/-/media/wco/public/global/pdf/topics/facilitation/activities-and-programmes/natural-disaster/covid\\_19/covid\\_19-categorization-of-member-input\\_may-29-2020\\_edition-4\\_en.pdf?la=en](http://www.wcoomd.org/-/media/wco/public/global/pdf/topics/facilitation/activities-and-programmes/natural-disaster/covid_19/covid_19-categorization-of-member-input_may-29-2020_edition-4_en.pdf?la=en)
- 7 [www.tfafacility.org/covid19-trade-facilitation](http://www.tfafacility.org/covid19-trade-facilitation)
- 8 [www.wcoomd.org/-/media/wco/public/global/pdf/about-us/administrative-documents/wco-strategic-plan-2019-2022pdf?db=web](http://www.wcoomd.org/-/media/wco/public/global/pdf/about-us/administrative-documents/wco-strategic-plan-2019-2022pdf?db=web)
- 9 [www.wcoomd.org/-/media/wco/public/global/pdf/about-us/administrative-documents/wco-strategic-plan-2019-2022pdf?db=web](http://www.wcoomd.org/-/media/wco/public/global/pdf/about-us/administrative-documents/wco-strategic-plan-2019-2022pdf?db=web)
- 10 The new monitoring tool is reserved for Member access only.
- 11 [www.wcoomd.org/-/media/wco/public/global/pdf/about-us/administrative-documents/wco-strategic-plan-2019-2022pdf?db=web](http://www.wcoomd.org/-/media/wco/public/global/pdf/about-us/administrative-documents/wco-strategic-plan-2019-2022pdf?db=web)
- 12 <http://www.wcoomd.org/-/media/wco/public/global/pdf/about-us/wco-in-brief/environmental-scan.pdf?db=web>
- 13 Revised Kyoto Convention
- 14 Trade Facilitation Agreement

### Ricardo Treviño Chapa



Ricardo Treviño Chapa has 20 years of experience in the public sector. He served as Mexico's Director General of Customs and after being elected by the WCO Council, in 2018 he took over the position of Deputy Secretary General. He led the change on the methodology and definition of the Organization's current Strategic Plan and is currently monitoring its implementation. He is in charge of updating the WCO environmental scan every year and will start the process of aligning and linking this scan to the next Strategic Plan including its strategic goals, priorities and deliverables.



# Managing customs risk and compliance: an integrated approach

*David Widdowson*

## Abstract

---

This article introduces a contemporary framework for managing compliance in the customs context that fully integrates the principal elements of customs risk and compliance management. In doing so, it explores the manifold resources that have been developed by the World Customs Organization (WCO) and other parties that may be used by administrations to support implementation of the framework.

The integrated model draws together the author's contribution to the literature over several years and provides practitioners with a logical and inclusive methodology for managing compliance at a strategic or operational level.

---

## 1. Introduction

The role of Customs, like any law enforcement agency, is to ensure compliance with the law; and while this responsibility has remained unchanged for centuries, the manner in which Customs performs its role has changed dramatically over the course of the past three decades.

Customs represents the regulatory touch point for internationally traded goods, and in a rapidly changing world of new and emerging technologies and heightened commercial imperatives, social and political expectations no longer accept the traditional regulatory approach of intervention for intervention's sake. Rather, the current catch-cry is intervention by exception—intervention when there is a legitimate need to do so—intervention based on identified risk.<sup>1</sup>

Although most customs administrations now espouse a policy of intervention by exception, there is routinely a lack of congruence between organisational policy and operational practice. One reason for this is the absence of a clear procedural linkage between two key elements of customs control—the management of risk and the management of regulatory compliance.

Numerous researchers have developed risk management and compliance management models in the regulatory context (for example, Ayres & Braithwaite, 1992; Sparrow, 2000; Widdowson, 2003, 2005 & 2012; Widdowson & Holloway, 2011; Wilcox-Daugherty, 2018; and WCO, 2014 & n.d.), many of which tend to focus on enforcement activities. However, an operational framework that explicitly integrates the two processes has not to this point been developed.

Sparrow (2000), when examining compliance management from a broader perspective, advocates the adoption of an integrated compliance strategy that specifically addresses identified risks. In doing so, he highlights the tendency for law enforcement agencies to rely solely on enforcement actions in their response to identified non-compliance, whereas an integrated compliance strategy provides regulators with a broad range of alternatives to enforcement in such situations.

This 'enforcement culture' is prevalent among customs auditors, many of whom assume that their objective is to detect errors in a company's regulatory dealings, rather than to assess the degree to which a company is complying with the relevant statutory requirements. What these auditors fail to realise

is that such an assessment, regardless of the result, assists in determining where future compliance resources should be directed.

A corollary to this is that an auditor's finding of compliance is as good a 'result' as a finding of non-compliance. This is often overlooked, since a finding of non-compliance generally brings with it a tangible revenue return to government, whereas the identification of a compliant trader does not (Widdowson, 2010). In a similar vein, Sparrow (2000) notes that an integrated compliance strategy allows the agency to identify the mitigation of risks as an equally legitimate accomplishment as enforcement action.

Furthermore, the international standard on risk management requires the risk management process to form an essential part of organisational decision-making and to be integrated into the structure, operations and processes of an organisation (ISO, 2018). This makes perfect sense, as fully integrating the risk and compliance management processes abates the likelihood of adopting suboptimal risk mitigation strategies to address identified cases of non-compliance.

The adoption of an integrated framework will provide compliance staff with a logical process for applying the principles of risk management in their day-to-day activities and, while recognising that compliance management is an intricate amalgam of art and science, the framework provides the necessary infrastructure for the delivery of an effective compliance program.

## 2. Risk management standard

ISO 31000 is the acknowledged international standard for managing risk. It provides a common approach to managing all forms of risk and is neither industry nor sector specific (ISO, 2018). Its first iteration was published in 2009 (ISO, 2009), but its origins lie in a standard that had been in use since 1995, that is, AS/NZS 4360 (Standards Australia/Standards New Zealand, 1995). This standard was developed by a small group of organisations that saw the need for a formal approach to the management of risk in a variety of settings.

At that time, the Australian Customs Service, a founding member of this group, was specifically seeking to adopt a risk management model that would support its trade compliance role and ensure that its efforts and resources were focused on areas of highest risk.<sup>2</sup> Recognising the potential application of AS/NZS 4360 in the broader customs community, the World Customs Organization (WCO) subsequently incorporated the Standard in its Risk Management Guide (WCO, 2003), which was the forerunner to its current Risk Management Compendium (WCO, n.d.).

The Standard was also incorporated into the Revised Kyoto Convention (RKC)<sup>3</sup> (WCO, 1999), which is widely regarded as the blueprint for contemporary and efficient customs operations. It is a requirement that parties to the Convention:

- limit customs control to that necessary to ensure compliance with the law (Standard 6.2)
- use risk management in the application of customs control (Standard 6.3)
- use risk analysis to determine which persons and which goods, including means of transport, should be examined and the extent of the examination (Standard 6.4)
- adopt a compliance measurement strategy to support risk management (Standard 6.5).

The World Trade Organization (WTO) Agreement on Trade Facilitation (WTO, 2014) also requires members to apply the principles of risk management in relation to customs control in order to avoid discriminatory practices, to focus regulatory resources on high risk consignments, and to expedite the release of low risk consignments (WTO, 2014, Article 7.4).

Note that, following the revision of AS/NZS 4360 in 2004, the joint Australia/New Zealand committee decided to promote the development of an international standard on risk management, based on its efforts to date. The resultant standard, ISO 31000 provides direction on how risk-based decision-making may be integrated into an organisation's governance, leadership, strategy, operations and culture.

### 3. Integrated Compliance Management Framework

This article introduces a contemporary approach that integrates the principal elements of customs risk and compliance management into a single operating framework. In doing so, it explores the manifold resources that have been developed by the WCO and other parties that may be used by administrations to support implementation of the framework. The integrated model (Figure 1) provides practitioners with a logical and systematic methodology for managing compliance in the customs context.

Figure 1: Integrated Compliance Management Framework

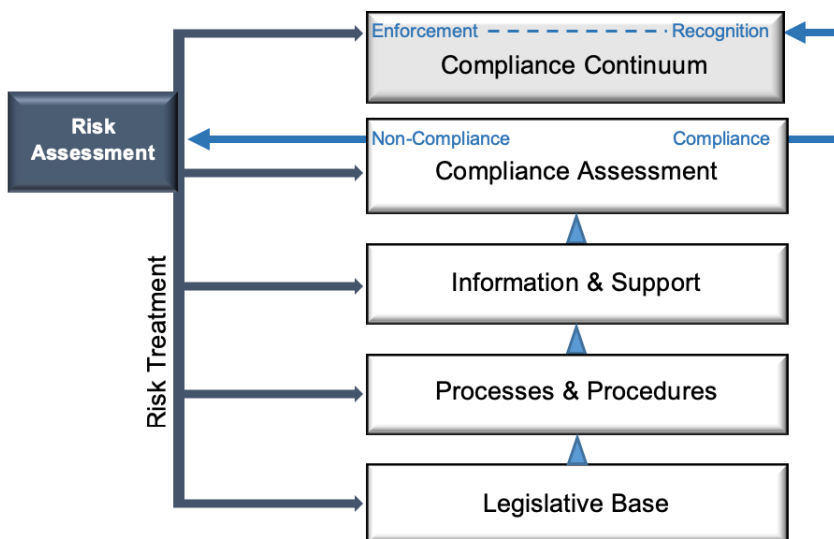

Source: Author

The framework incorporates the key aspects of an effective risk-based compliance management strategy, including:

- the law that is to be enforced
- processes and procedures that regulate the way in which the law is applied
- services to support the community's ability to comply with the law
- methods of assessing compliance with the law
- processes for assessing risks of non-compliance with the law
- techniques to mitigate identified risks
- strategies to address the continuum of compliance behaviour.

In essence, the framework is based on the legislation and associated processes and procedures which represent the regulatory requirements for which Customs has administrative responsibility. This includes all aspects of their direct regulatory responsibilities, including the import, export and transit of goods, as well as any matters that are administered on behalf of other agencies, such as health, agriculture, taxation, environment, statistics and in some cases, immigration. In order to ensure compliance with such requirements, there is firstly a need to make certain that members of the trading community are aware of their rights and responsibilities, by providing them with the necessary information and support to comply.

It is then necessary to assess levels of compliance through the use of various techniques such as data screening, documentary checks, non-intrusive inspection, audit and investigation, the result of which will be the identification of either compliance or non-compliance. Where non-compliance is identified, the reason for non-compliance must be established by assessing the relevant risk, leading to the identification of appropriate risk mitigation strategies, which may involve revisiting the legislative base, processes and procedures, information and support, or compliance assessment techniques, or may require some form of enforcement action. In situations where compliance is identified, the appropriate response is to actively recognise the compliant behaviour.

In practice, the level of compliance identified will form part of a continuum from criminal behaviour and fraud through to voluntary compliance. The relevant response will therefore depend on the trader's position on the compliance continuum. Enforcement strategies for identified non-compliers include warnings, penalties and other sanctions, while recognition strategies for compliers include increased levels of self-assessment, reduced regulatory scrutiny, and increased levels of facilitation.

### 3.1 Legislative base

In the broadest sense, the risk to be managed by any government agency is the risk to the achievement of its fundamental objective, that is, the risk of non-compliance with the laws for which it has administrative responsibility. Not surprisingly then, the starting point for the compliance management framework is the administration's legislative base, which may be very broad or quite limited, depending on the context in which the framework is being applied. For example, an administration's overall trade compliance strategy will need to encompass all associated statutory and regulatory provisions, whereas the focus of a particular customs audit is likely to be far more narrowly defined.

Regulations, often referred to as secondary or subordinate legislation, are regarded as extensions of a country's statutes, providing a greater degree of detail than would be practical to include in the primary legislation. For example, whereas primary legislation would allow duty-free goods to be sold to travellers, secondary legislation may require the duty-free shop operator to sight an approved travel document before selling the goods. In this model, both levels of regulation are included in the legislative base.

The RKC, which is designed to simplify and harmonise customs procedures on a global basis, provides a wealth of information on all aspects of customs law, both in terms of what should be included in national legislation and how it should be administered. It is also designed to facilitate legitimate trade and to ensure appropriate standards of customs control. In recognition of the fact that the focus of customs authorities is enforcement of their domestic laws, it is a requirement that member states incorporate the RKC's various conditions, formalities, practices and procedures in their national legislation (RKC Standard 1.2). Importantly, Standard 1.2 also specifies that such regulatory requirements should be as simple as possible.



The Harmonized System Convention<sup>4</sup> (WCO, 1986) is another important instrument that has been developed by the WCO to achieve international uniformity in the classification of goods. The Harmonized System (HS), which forms the basis of the tariff legislation in over 200 countries and economies, is relevant to a range of customs functions, including tariff classification, international trade statistics, rules of origin and tariff concessions.

The WCO SAFE Framework of Standards<sup>5</sup> (WCO, 2018) is also a significant policy document that builds on the provisions of the RKC by providing more specific guidance on customs policies and procedures to secure and facilitate cross-border trade. Over 170 countries have expressed their intention to implement the provisions by incorporating them into their national regulatory requirements.

The provisions of the WTO Agreement on Trade Facilitation complement those of the RKC and the SAFE Framework through their focus on particular policies and procedures that support the facilitation of international trade. These include areas such as publication and availability of information, advance rulings, customs formalities, release and clearance of goods, and border agency cooperation. It is a requirement for member states to implement these provisions through their national legislation, and to date over 120 countries have notified their intention to do so.

There are of course many other sources of international law which form the basis of national customs legislation, including the numerous instruments that form part of the United Nations treaty collection and those administered by the WTO—notably the GATT<sup>6</sup> and the Agreement Establishing the World Trade Organization,<sup>7</sup> the latter including other important elements of customs law such as the Agreement on Trade Facilitation, the TRIPS Agreement,<sup>8</sup> and the Valuation Agreement,<sup>9</sup> among others.

### **3.2 Processes and procedures**

Regulatory processes and procedures provide further clarity and detail about how a particular law is administered and enforced. For example, in the previous section we noted that while primary legislation allows duty-free goods to be sold to travellers, secondary legislation may require an approved travel document to be sighted prior to such a sale. What constitutes an ‘approved travel document’ may then be further defined in administrative guidelines, which may stipulate, for example, an overseas ticket or boarding pass and valid passport.

Such guidelines, directives, operating instructions, procedural statements and the like therefore support the application of legislative provisions by specifying details such as information that must be provided to the authorities, the manner and timeframe in which it should be provided, the way in which compliance may be demonstrated, and the systems and procedures that are deemed to satisfy legal provisions. They put the meat on the legislative bones by providing the degree of detail that may not be appropriate to include in the statutes or regulations, particularly in relation to matters that may be subject to regular review.

The manner in which such processes and procedures may be determined often allows the administration a degree of flexibility in terms of the way in which laws are enforced. For example, the legislation may require traders to obtain a permit in order to import certain commodities. However, Customs may have the discretion to administer this provision in a number of different ways, depending on the perceived level of risk. Trusted traders may, for example, be granted a permit that allows unlimited importation for a period of time, whereas higher risk traders may be required to obtain permits on a shipment-by-shipment basis.

Importantly, as noted in the preamble to the RKC, customs procedures and practices should be applied in a predictable, consistent and transparent manner.

The resources available to support administrations in the design, implementation, maintenance and refinement of their processes and procedures are extensive. The best place to start is the RKC, specifically the guidelines to the General Annex and the Specific Annexes. The General Annex Guidelines cover a broad range of procedures such as clearance, duties and taxes, security, customs control, use of information technology, rulings and appeals, while the Specific Annex Guidelines address the arrival of goods, importation, exportation, warehouses and free zones, transit, processing, temporary admission, offences, special procedures, and origin.

As an example, Standard 4 of Specific Annex D requires Customs to develop requirements for the establishment and use of customs warehouses, and the associated guidelines identify particular controls that should apply, such as those related to physical security, supervision and accounting, as well as matters that should be considered when determining any specific requirements that should apply to individual premises.

The WCO SAFE Package<sup>10</sup> provides comprehensive guidance on practical aspects of the SAFE Framework including guidelines on integrated supply chain management, non-intrusive inspection of cargo, advance cargo initiatives, Authorised Economic Operator (AEO)<sup>11</sup> programs including validation guides and mutual recognition, together with a collection of best practice examples from member administrations.

Specific resources relating to the classification, valuation and origin of goods can be found in the WCO's Revenue Package,<sup>12</sup> which provides useful guidance on matters such as verification of preferential origin, origin certification, customs infrastructure for tariff classification, valuation and origin and technical guidelines on advance rulings.

There are many other potential sources of guidance on legal processes and procedures. All international organisations produce resolutions, decisions, declarations, recommendations, guidelines, operating directions and the like in relation to the implementation of particular treaties, conventions and standards.

### 3.3 Information and support

No matter how clear and predictable the law and its associated processes and procedures may be, it must be appropriately publicised if members of the trading community are to properly understand their legal rights and responsibilities. Put simply, if they don't know what the rules are, how can they be expected to comply? Providing clear information and relevant support to those who are being regulated is therefore an essential element of effective compliance management. In this regard, the regulated community goes beyond traders, and includes brokers, freight forwarders, carriers, port operators, warehouse operators and other service providers.

The manner in which regulatory requirements are publicised will vary depending on the circumstances, but a logical starting point is to provide comprehensive information on the administration's website. This should include, as a minimum, the legislation itself; details of any rulings, decisions and determinations that help inform the way in which the law is interpreted; a clear overview of relevant processes and procedures; administrative guidelines and explanatory material such as factsheets that serve to clarify such processes; and details of where further information may be obtained, including available learning packages.

An important principle of good compliance management is that, unless there are sound legal reasons to do so, the public should not be denied access to any information that is available to the administration itself. The WCO, when first introducing its Revenue Package (WCO, 2011), addressed the need for member administrations to access all applicable materials included in the package to ensure that all relevant revenue collection requirements were being met. At the same time it noted:

It is equally important that commercial operators have access to the unrestricted information produced by the WCO and other bodies, which can assist an importer in meeting its obligations to Customs in respect of declaring and paying the correct Customs duty and to be aware of its rights and expectations (WCO, 2011, p. 1).

Similarly, a guiding principle of the RKC is that its rules and practices should be transparent and accessible to anyone who may be dealing with Customs, and that interested parties should be provided with all necessary information regarding customs laws, regulations, administrative guidelines, procedures and practices.<sup>13</sup> Further, while holding the declarant responsible for the accuracy of a goods declaration (Standard 3.8), the RKC requires that all relevant information concerning customs law is readily available to any interested person (Standard 9.1). The associated guidelines make it clear that the scope of such information is extremely broad:

Such information would include the tariff classification of goods, rates of duty and taxes, valuation of goods for Customs purposes, information relating to exemptions, prohibitions and restrictions, Customs administrative arrangements and requirements, and any other pertinent information which will be of interest to the relevant interested parties (RKC General Annex Guidelines, Ch. 9, Standard 9.1).

Guidance relating to the more technical aspects of customs administration include the HS Explanatory Notes, Compendium of Classification Opinions, Harmonized System Database, HS Classification Handbook, Classification decisions taken by the HS Committee, Instruments of the WTO Valuation Committee and the advisory opinions, commentaries, case studies and explanatory notes of the Technical Committee on Customs Valuation.

On a more general note, the RKC addresses the need for information to be of high quality, accurate, relevant, clear, current and readily available; and provides examples of ways in which such information may be made available directly to interested parties as well as through more structured trade consultation processes.<sup>14</sup> In this regard, the Convention requires that Customs establish consultative, cooperative relationships with the international trading community in order to achieve effective operating methods that comply with relevant regulatory requirements (RKC Standard 1.3).

Other relevant standards include the requirement that, when asked for information relating to specific matters of law, Customs should respond quickly and accurately (Standard 9.4), and provide any additional advice that is considered to be of relevance to the request (Standard 9.5). Further, in relation to decisions and rulings, the Convention requires that these be notified in writing if so requested (Standard 9.8) and that if requested—and there is sufficient information to do so—such rulings should be binding in nature.

The WTO Agreement on Trade Facilitation (WTO, 2014) also provides useful guidance on the level of information and support that is expected of regulatory agencies. This includes, but is not limited to, prompt publication of information on legal requirements in a readily accessible manner; providing details of regulatory requirements, processes and procedures on the Internet; establishing enquiry points such as help desks; issuing advance rulings; and establishing appeal and review procedures. Note that, in terms of the appeal process, the RKC preamble identifies a requirement to provide easily accessible processes of administrative and judicial review to affected parties, while Standard 10.2 requires that those who are directly affected by a decision or omission of Customs should have a right of appeal.

### 3.4 Compliance assessment

Customs has a responsibility to enforce the law, and to do so it is necessary to firstly determine whether those who are being regulated are complying with the law. The powers that are available to officers to undertake this task are generally quite extensive. Like the laws they are assigned to enforce, the powers of officers must themselves be based in legislation, supported by formal processes and procedures, and promulgated to ensure that the public is fully aware of the administration's legal authority. (WCO, 2011, pp. 1–2).

The various methods of assessing compliance all form part of the system of customs control, which is addressed in Chapter 6 of the RKC. The Convention specifies that all internationally traded goods shall be subject to customs control (Standard 6.1)<sup>15</sup> and provides that such control shall be limited to that necessary to ensure compliance with the law (Standard 6.2), and that it should be applied using the principles of risk management (Standards 6.3 and 6.4). Consequently, there is a clear expectation that the various methods of compliance assessment should be applied in a way that provides legitimate trade and travel with an appropriate level of facilitation, and while physical intervention is appropriate in certain circumstances, such methods should only be used when there is a legitimate risk-based reason to do so.

The arsenal of controls that is available to Customs includes data screening and verification (generally prior to arrival); profiling and targeting; documentary checks; non-intrusive inspection; physical examination of the goods, including verification checks and analysis; leverage exercises;<sup>16</sup> pre- and post-clearance audit activity, including desk and physical audits; and investigations.

Analysing the results of a prudential audit is another legitimate method of assessing compliance. Such audits are undertaken by a third party at the request of a regulated entity to obtain an independent assessment of their level of compliance with statutory or other requirements. Prudential audit results may be taken into account by the regulator when assessing the risks associated with the particular entity, thereby complementing rather than replacing other forms of assessment. Accordingly, a prudential audit cannot be regarded as a mechanism for avoiding a customs audit.

In relation to audit procedures, the RKC asserts the need for these to be consistent with a country's generally accepted accounting principles (GAAP),<sup>17</sup> and highlights the value of the systems-based audit approach (commonly referred to as post-clearance audit, or PCA) that involves an evaluation of a trader's commercial systems and procedures. The Convention describes PCA as 'an effective tool for Customs control because it provides a clear and comprehensive picture of the transactions relevant to Customs as reflected in the books and records of international traders'.<sup>18</sup>

Regardless of which methods of compliance assessment are selected, they should be applied in a way that enables the administration to identify both compliant and non-compliant behaviour. As noted previously, it is just as important to identify those who are complying with regulatory requirements as it is to identify those who are not. By determining that certain members of the trading community are compliant, that is, 'low risk', the administration is able to focus its attention on those for which the risk has yet to be assessed. The WCO's AEO program, which embodies the principles of risk management, encourages administrations to actively identify low risk members of the international trading community for this reason.

Bersin (2012) uses a 'needle in the haystack' analogy to describe this principle, noting that one way to find the needle is to reduce the size of the haystack by differentiating between high and low risk consignments. It is the identification of compliant traders that enables the haystack to be shrunk in this way. Note, however, that the successful application of this strategy requires the administration to accept that a finding of compliance by the audit team is a legitimate and useful operational outcome.

The RKC provides valuable guidance on compliance assessment techniques including, but not limited to, documentary examination; physical examination and search; the identification of goods; and audit-based controls, including post-clearance audit. It also provides guidance on the necessary supporting infrastructure, including management, procedures and human resource development. In addition, the Convention provides extensive guidance on the use of information and communications technology (ICT) to support customs control.<sup>19</sup>

Other useful guidance on compliance assessment can be found in the WCO Voluntary Compliance Framework (WCO, 2014), which includes reference to the compliance frameworks of its member administrations. The WCO SAFE Package also includes comprehensive guidance in the context of AEO validations, including detailed validation procedures and information on best practices.<sup>20</sup> The WCO Revenue Package is another useful source of information, particularly in relation to its PCA Guidelines and Diagnostic Tool on PCA and infrastructure, as is the World Bank's post-clearance audit reference and implementation guide (Widdowson & Preece, 2013).

The result of any compliance assessment activity is the identification of either compliance or non-compliance. The way in which these two outcomes are addressed under the integrated framework is discussed in the following sections.

### 3.4.1 Findings of non-compliance

The traditional four-step approach to compliance management is to audit a company, find an error, penalise the company and leave. This achieves little in terms of improving future levels of compliance within the trading community, and is indicative of Sparrow's (2000) enforcement culture.

An effective compliance management strategy goes much further than this, by firstly seeking to find the cause of non-compliance and then identifying ways of preventing its recurrence. This is achieved through the application of the risk management process, the key elements of which are shown in Figure 2.

Figure 2: Risk management process

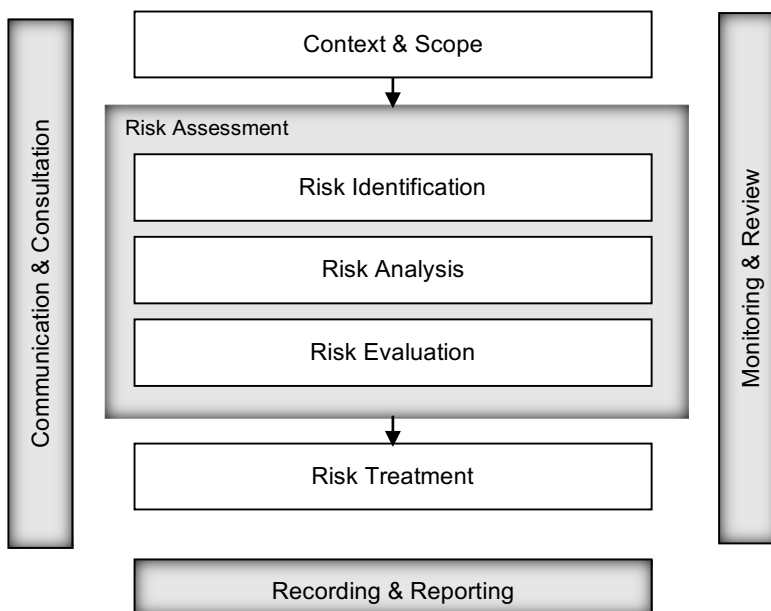

Source: Modified from ISO 31000 (ISO, 2018)

### Context

The context and scope of the risk that is being managed is already defined by the context and scope of the audit (or other compliance assessment activity) itself. For example, the audit may be focusing on a trader's compliance with customs requirements in general, or with particular aspects of the regulations such as those relating to transit, export or warehousing activities.

### Risk identification

Risk identification, which is the first step of the risk assessment process, essentially involves answering two questions:

- What could happen that may have an impact on the agency's objectives?
- How and why could it happen?

The first question helps to clarify the nature of risk while the second provides valuable information about potential causes. Note, however, that the error identified during the course of the audit (or other compliance assessment activity) has already answered the first of these questions. The next task is to determine how and why the error has occurred. For example, the company may have made an inadvertent error, its procedures may be flawed, there may be a general misconception within the industry sector about the customs treatment of certain goods, or indeed the error may have resulted from an intentional act. On the other hand, the legislation may be unclear or the administrative requirements may be ambiguous.

### Risk analysis and evaluation

The next step is to analyse the risk by considering two discrete elements—the likelihood of the risk occurring, and the impact if it does in fact occur. The impact or consequence of a risk occurring is relatively easy to quantify in the context of revenue compliance, whereas in other situations there is generally a need to make qualitative assessments—for example, failure to obtain import or export permits.

Determining the likelihood of a risk occurring depends on two factors—those which Customs can control, and those which it cannot. Thus, when considering the likelihood of a risk occurring, it is important to take into account the existing customs controls that are designed to minimise the likelihood of non-compliance. When examining these factors in a criminal context, the effectiveness of existing controls is often referred to as 'vulnerability', whereas the factors over which Customs has little or no control are referred to as the 'capability' and 'intent' of the criminal organisation. In the intelligence community, the assessment of capability and intent is generally referred to as a threat assessment.

What constitutes a control regime essentially refers to the legislative, physical and information-related processes that are in place to minimise the likelihood of non-compliance. For example, when a truck crosses a border, it is required to do so at a specified location and certain formalities must be completed before the driver, the truck and its cargo are authorised to proceed. Similarly, a traveller arriving at an airport is not free to exit via the nearest gate but must follow clearly defined physical and documentary procedures before being authorised to leave the airport. In the absence of such requirements, it would be impossible to exercise any semblance of regulatory control (Widdowson, 2012).

Both the likelihood and impact of a risk are taken into account when determining the overall level of risk that has been identified. This then leads to the risk evaluation stage, which involves determining whether a risk is acceptable or unacceptable, and how the unacceptable risks are to be prioritised.

## **Risk treatment**

Having identified the risks that require mitigation, the next step is to identify effective strategies that, in future, will eliminate or minimise the likelihood of the risk recurring, its potential impact, or both. In this regard, the appropriate mitigation strategy will depend on how or why the risk occurred. It may, for example, be necessary to address systemic problems within the company, or there may be a need to review the administration's published guidelines, or perhaps formal clarification of the law through binding rulings may be the most appropriate solution.<sup>21</sup> As such, one or more stages of the Integrated Compliance Management Framework will need to be reviewed.

If, for example, errors are occurring due to the complexity of the law, it may well be necessary to redraft the relevant legislation and/or the associated regulatory processes and procedures. While ignorance of the law may be no excuse, a poorly constructed, unpublicised or ambiguous regulatory framework can often explain instances of non-compliance. The need to amend the law may also arise as a result of the introduction of new government policies, and may well occur with very little warning, as was the case with the recent pandemic-driven measures to regulate cross-border trade in personal protective equipment (PPE) and other essential items. A further example is the global review of legislative provisions to adequately address new and emerging trends in international trade, such as e-commerce and blockchain technology.

The provision of information and support also represent valid risk mitigation strategies in situations where the reason for non-compliance is deemed to be a lack of knowledge, understanding, clarity or certainty on the part of the regulated community. Traders cannot be expected to comply with regulatory requirements in the absence of timely and open access to information that fully informs them of their legal rights and responsibilities.

In this context, an analysis of the errors detected as a result of compliance assessment activities may indicate the need for existing published advice to be revised, clarified or expanded; or for new guidelines or explanatory material to be promulgated. Such analysis may also demonstrate the need for the administration to enhance its use of formal decisions and rulings in respect of certain goods or activities. Equally, the results of the assessment may point to systemic flaws in the trader's systems or procedures, for which a compliance improvement plan can be developed.

Analysis of compliance assessment results may further indicate that detected errors may not be restricted to the entity that was the subject of the audit or other activity, and that other members of the trading community may be making similar errors. In such instances, it will be necessary to develop a compliance assessment plan that is designed to identify the extent of the problem. For example, the issue may be confined to a particular industry sector, or may have wider effect.

Note also that the way in which compliance assessment activities are conducted may lead to a failure to properly detect instances of non-compliance. For example, officers involved in such activities may not have the necessary knowledge, skills and competencies; there may be insufficient compliance resources, including equipment and technology; the range of available compliance assessment options may be restrictive; intelligence support may be ineffective; ICT systems may be inadequate; and operational procedures may be deficient. Equally, the compliance assessment activities may be ineffective due to poor management, including the lack of an effective national compliance management strategy upon which operational activities may be based. Consequently, ways of addressing shortcomings of this nature should also be considered when developing risk mitigation strategies.

Finally, it should be recognised that, while some non-compliers may genuinely make 'honest mistakes', others will deliberately attempt to circumvent the law regardless of how much information and support is provided, in which case enforcement strategies are required. Indeed, while the majority of traders and service providers will seek to meet their legal obligations, others will do so only in response to direct

enforcement activity, which essentially represents another form of risk treatment. Such activities are necessary to achieve compliance among those members of the trading community in whose lexicon the term ‘voluntary compliance’ does not exist.

Ayres and Braithwaite (1992) present a model known as the ‘Enforcement Pyramid’ which has been used as the basis of national customs enforcement strategies for many years. The purpose of their research was to determine the form of sanction that would achieve the highest level of improvement in compliance in different circumstances. The model provides a spectrum of compliance management options that range from persuasion, through to warning letters, civil penalties, criminal penalties, licence suspension, and finally licence revocation.

The WCO Customs Risk Management Compendium contains a wealth of practical information that will assist administrations to assess risk and identify effective risk mitigation strategies. The compendium includes guidance on developing an organisational framework for managing risk; embedding risk management in the organisational culture; risk assessment, profiling and targeting; risk indicators; and guidelines for intelligence analysis.

Other useful resources include the World Bank’s Risk-Based Compliance Management Guide,<sup>22</sup> the WCO Enforcement Guidelines; WCO Strategic Trade Control Enforcement Implementation Guide; WCO Commercial Fraud Manual; WCO Guidelines on the development and use of a National Valuation Database as a Risk Assessment Tool; the WCO Mirror Analysis Guide, which includes case studies; and the WCO Good Practices Guide, including case studies relating to informal trade.<sup>23</sup>

### 3.4.2 Findings of compliance

As previously noted, a finding of compliance by the audit team is a legitimate and useful operational outcome. This is because, for every instance of compliance that is identified, the population of potential non-compliers reduces. The question then becomes, how should compliant traders be treated from a regulatory perspective?

It is now widely accepted that traders who are able to demonstrate high levels of compliance require a lower level of scrutiny than those with a history of poor compliance, or those about which little is known (Widdowson, 2010, p. 25). However, there is also an increasing realisation that compliant behaviour should not only be recognised through a reduction in regulatory scrutiny, but through various forms of positive reinforcement. Indeed, the WCO SAFE Framework formally recognises the need to provide benefits to compliant companies in the context of its AEO concept. According to the WCO:

Authorized Economic Operators will reap benefits, such as faster processing of goods by Customs, e.g. through reduced examination rates... These processes will ensure that AEOs see a benefit to their investment in good security systems and practices, including reduced risk-targeting assessments and inspections, and expedited processing of their goods. (WCO, 2018, p. 5).

The WCO further specifies that such benefits should be clear, tangible and documented in order to provide members of the trading community with an incentive to seek AEO status, and to justify the costs incurred in achieving such status (WCO, 2018, Annex IV/2). As such, the WCO provides a formal link between a trader’s low risk rating and the provision of regulatory benefits.

As noted by Widdowson (1998, p. 99), such an approach had previously been adopted by individual customs administrations, describing it as ‘a more effective approach to compliance management which not only recognises the need to balance enforcement with assistance, but further recognises the benefits of providing industry with incentives to comply. In other words, more carrot and less stick’. However, it was the introduction of the first iteration of the WCO SAFE Framework in 2005 that legitimised the practice at the international level, thereby reinforcing the need to ensure that an appropriate balance exists between incentives for compliance and sanctions for non-compliance.



The WCO provides a comprehensive list of potential AEO benefits that its members should consider when developing their national programs (WCO, 2018, Annex IV). These include measures that are designed to expedite cargo release, reduce transit time, lower storage costs, facilitate post-release processes, and to provide support during periods of trade disruption or elevated threat levels. In addition, the WCO identifies benefits that may apply under mutual recognition arrangements<sup>24</sup> and specific benefits that may apply to different sectors of the industry, such as exporters, importers, warehouse operators, manufacturers, customs brokers, logistics operators, and other service providers.

Article 7 of the WTO Trade Facilitation Agreement requires members to provide trade facilitation measures for authorised operators in a manner similar to the AEO concept, although the level of guidance provided is minimal. Without referencing the WCO SAFE Framework, the WTO also encourages members to develop authorised operator schemes on the basis of international standards, even though the SAFE Framework is widely acknowledged to be the only international standard of its type.

### 3.5 Compliance continuum

The concept of a compliance continuum recognises the fact that some members of the regulated community will always seek to comply, while others have no intention to do so. These two ‘compliance behaviours’ sit at opposite ends of the compliance continuum (see Figure 3). Those who willingly comply represent the lowest risk, and those who are deliberately non-compliant represent the highest risk.

Figure 3: Compliance continuum

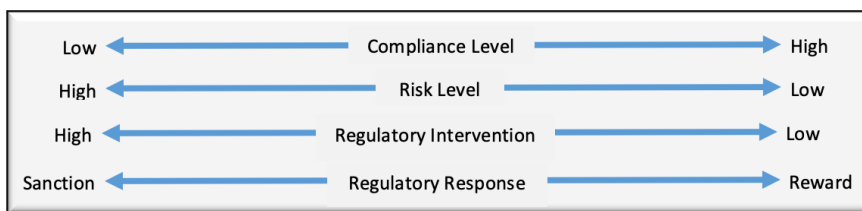

Source: Author

The appropriate regulatory response will depend on where the regulated entity sits on the continuum, and will range from the highest level of penalty to the highest status of AEO. Most members of the international trading community will fall between these two extremes, and the more compliant they become, the less punitive the regulatory response will be.

Ayres and Braithwaite (1992) contend that the softer regulatory approaches are likely to be employed most frequently by regulatory authorities and that, as the severity of the sanction increases, the incidence of usage is likely to decrease. Ayres and Braithwaite (1992) further argue that, as the enforcement strategy available to the regulatory agency increases in its severity, the agency is likely to be more effective in achieving compliance and is less likely to be required to resort to tough enforcement actions. In other words, as the size of the stick increases, the need to use it decreases. They further contend that self-regulation (or self-assessment) is a legitimate compliance management strategy for regulators to employ in situations where certain members of the regulated community are deemed to be relatively trustworthy, that is, pose a relatively low risk of non-compliance. Under such an arrangement, these parties are permitted to undertake their own assessment of their compliance with the relevant regulations, on the understanding that such assessment may be subjected to some form of government verification.

Different models are in use to map compliance strategies against a compliance continuum, several of which are included in the WCO's Voluntary Compliance Framework. In the Canadian model, for example, the compliance strategy for those who are 'willingly compliant' is one of facilitated voluntary

compliance, whereas for those who are ‘purposely non-compliant’, the response is one of enforced compliance. Similarly, in the New Zealand model, for ‘people who are willing to do the right thing’, the administration will make it easy for them to comply, whereas the full force of the law will be applied to ‘people who decide not to comply’. Regulatory strategies between the two extremes come into play as compliance levels change.

The Australian model, which also maps compliance behaviour against regulatory responses, goes further by identifying the types of regulatory interventions that are considered appropriate to address certain types of compliance behaviours. For example, at the low risk end of the continuum the administration adopts a ‘self-regulation’ approach, using a monitoring program to oversee compliance behaviour, whereas at the other extreme an ‘enforced regulation’ approach is adopted, which involves investigation and prosecution. For those traders who are seeking to comply but not yet compliant, a strategy of ‘assisted self-regulation’ is employed, which includes a range of support services including education and advice.

Models that illustrate the compliance continuum generally depict the distribution of compliance behaviours as a straight line, as represented by the broken line in Figure 4. However, it is likely to be more appropriately represented by a skewed distribution curve, as represented by the solid line, in which the compliance levels of the majority of regulated entities are relatively high.<sup>25</sup>

Figure 4: Compliance continuum distribution curve

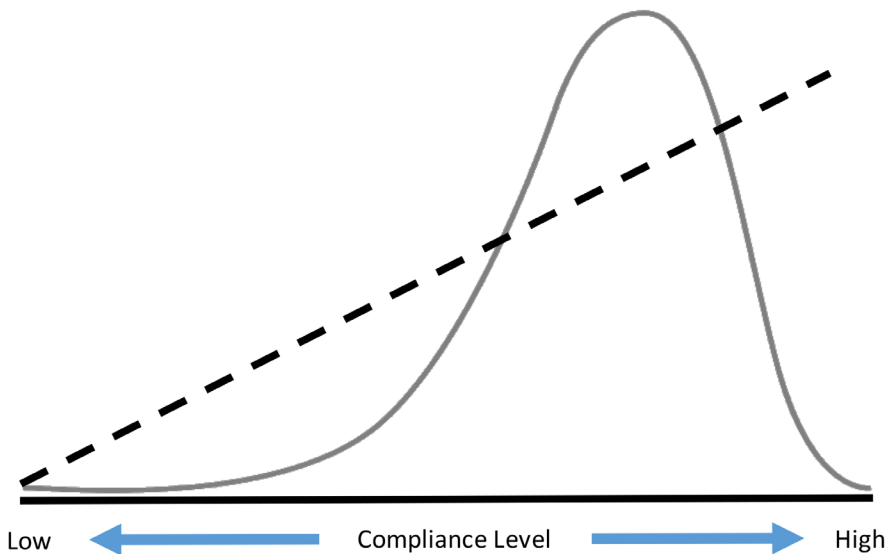

Source: Author

## 4. Conclusion

Several models have been developed to assist customs administrations manage compliance in a more structured and systematic way. At the same time, formal methodologies for managing risk have been established, based on what have now become international standards. However, an operational framework that explicitly integrates the two processes has not to this point been devised.

The absence of a clear procedural linkage between the management of risk and the management of regulatory compliance, both of which are critical to the achievement of effective customs control, has not only caused confusion in the application of the discrete methodologies, but has also resulted in a lack of congruence between regulatory policy and what actually occurs in practice.

The Integrated Compliance Management Framework presented in this article draws together the author's contribution to the literature over several years. It introduces a contemporary method of managing compliance in the customs context that fully integrates the principal elements of customs risk and compliance management, thereby providing practitioners with a logical and inclusive methodology for managing compliance at a strategic or operational level. In doing so, it identifies the manifold resources that are available to facilitate implementation of the framework, in particular those developed by the WCO.

## References

- Australian Attorney-General's Department, Office of General Counsel. (1993). *Review of the Australian Customs Service 1993: The turning point*. Australian Government Publishing Service.
- Ayres, I., & Braithwaite, J. (1992). *Responsive regulation: Transcending the deregulation debate*. Oxford University Press.
- Bersin, A. (2012). Lines and flows: The beginning and end of borders. *Brooklyn Journal of International Law*, 37(2), 389–406.
- International Organization for Standardization. (ISO). (2009). *Risk management—Principles and guidelines* (ISO Standard No. 31000:2009).
- International Organization for Standardization (ISO). (2018). *Risk management—Guidelines* (ISO Standard No. 31000:2018).
- Sparrow, M. (2000). *The regulatory craft—Controlling risks, solving problems, and managing compliance*. The Brookings Institution.
- Standards Australia/Standards New Zealand (AS/NZS). (1995). *Risk management* (AS/NZS Standard No. 4360:1995).
- Widdowson, D. (1998). Managing compliance: More carrot, less stick. In C. Evans & A. Greenbaum (Eds.), *Tax Administration: Facing the challenges of the future* (pp. 99–104). Prospect.
- Widdowson, D. (2003). *Intervention by exception: A study of risk management by customs authorities in the international trading environment*. [Doctoral thesis, University of Canberra].
- Widdowson, D. (2005). Managing risk in the customs context. In L. De Wulf & J. B. Sokol, *Customs modernization handbook* (pp. 91–99). The World Bank.
- Widdowson, D. (2010). Risk management: Key enablers. *WCO News*, 62, 25–27.
- Widdowson, D., & Holloway, S. (2011). Core border management disciplines: Risk based compliance management. In Mclinden, G., Fanta, E., Widdowson, D., & Doyle, T. (Eds.) *Border management modernization* (pp. 95–113). World Bank.

- Widdowson, D. (2012). *Risk-based compliance management – Making it work in border management agencies*. The World Bank.
- Widdowson, D., & Preece, R. (2013). *Post clearance audit: Reference and implementation guide*. The World Bank.
- Widdowson, D., Blegen, B., Kashubsky, M., & Grainger, A. (2014) Review of accredited operator schemes: An Australian study. *World Customs Journal*, 8(1), 17–34.
- Wilcox-Daugherty, L. (2018). *Customs modernization handbook: Applying risk management in the cargo processing environment*. USAID.
- World Customs Organization (WCO). (1986). *International Convention on the Harmonized Commodity Description and Coding System (with annex), as amended by the Protocol of Amendment of 24 June 1986*.
- World Customs Organization (WCO). (1999). *International Convention on the simplification and harmonisation of customs procedures (as amended), June 26, 1999*.
- World Customs Organization (WCO). (2003). *Risk Management Guide*. WCO.
- World Customs Organization (WCO). (2011) *Revenue Package Information Note*. WCO.
- World Customs Organization (WCO). (2014). *Voluntary Compliance Framework*. WCO
- World Customs Organization (WCO). (2018). *WCO SAFE Framework of Standards*. WCO.
- World Customs Organization (WCO). (n.d.). *WCO customs risk management compendium*. WCO.
- World Trade Organization (WTO). (1994). *WTO Agreement: Marrakesh Agreement establishing the World Trade Organization, Apr. 15, 1994*.
- World Trade Organization (WTO). (2014). *Protocol amending the Marrakesh Agreement establishing the World Trade Organization (Agreement on trade facilitation), Nov. 27, 2014*.

## Notes

- 1 Intervention by exception is a term which the author first coined in the 1980s to describe a regulatory compliance strategy that is based on the principles of risk management. It later became the title of his doctoral thesis (Widdowson, 2003)
- 2 This followed a major review of the organisation—see Australian Attorney-General's Department, Office of General Counsel (1993)
- 3 The Convention on the Simplification and Harmonization of Customs Procedures (as amended), which entered into force in 2006
- 4 International Convention on the Harmonized Commodity Description and Coding System (with annex), as amended by the Protocol of Amendment of 24 June 1986
- 5 The SAFE Framework of Standards to Secure and Facilitate Global Trade was originally adopted at the June 2005 WCO Council Sessions, and has been updated several times since, the latest edition being published in 2018
- 6 General Agreement on Tariffs and Trade
- 7 Agreement establishing the World Trade Organization 1994, also known as the Marrakesh Agreement or WTO Agreement (WTO, 1994)
- 8 Agreement on Trade-Related Aspects of Intellectual Property Rights
- 9 Agreement on Implementation of Article VII of GATT
- 10 The WCO SAFE Package includes the SAFE Framework itself (WCO, 2018), and a range of instruments and guidelines such as Customs Guidelines on Integrated Supply Chain Management, NII Guidelines, Threats and Technology Solutions, Advance Cargo Information (ACI) Implementation Guidance, a number of AEO guidance documents, Strategy Guide for AEO Mutual Recognition, Coordinated Border Management Compendium, Single Window Compendium, Trade Recovery Guidelines, and best practice guides
- 11 An Authorised Economic Operator (AEO) is a member of the international trading community that is deemed to represent a low Customs risk and for whom greater levels of facilitation should be accorded (see Widdowson et al., 2014)
- 12 The WCO Revenue Package is a comprehensive collection of tools and instruments relevant to revenue collection including formal instruments and conventions, guidance notes and training material
- 13 See, for example, the Preamble to the RKC
- 14 General Annex Guidelines, Chapter 9, Standard 9.1
- 15 RKC Standard 6.1 provides that all goods, including means of transport, which enter or leave the Customs territory, regardless of whether they are liable to duties and taxes, shall be subject to Customs control
- 16 A leverage exercise is designed to achieve maximum compliance impact with minimum effort. For example, based on a particular finding of non-compliance in one company, Customs may contact other companies involved in similar activities, asking them to review their records and make voluntary adjustments for any errors found. Penalties are generally waived if adjustments are of a voluntary nature
- 17 See the Guidelines to RKC Standard 6.6
- 18 See the Guidelines to RKC Standard 6.10
- 19 See RKC General Annex Chapter 7 and associated Guidelines
- 20 The WCO Customs AEO Validator Guide, which forms part of the SAFE Package, is particularly useful
- 21 See, for example, Widdowson (1998)
- 22 Widdowson (2012)
- 23 These are available either through the WCO website, [www.wcoomd.org](http://www.wcoomd.org), or directly from the WCO
- 24 Where two countries have a Mutual Recognition Agreement (MRA) in place, an entity's AEO status is to be recognised by the customs administrations of both economies
- 25 Based on preliminary research findings of the author

**David Widdowson**



Professor David Widdowson is Chief Executive Officer of the Centre for Customs and Excise Studies at Charles Sturt University, Australia. He is President of the International Network of Customs Universities, a member of the WCO's PICARD Advisory Group and Scientific Board, and a founding director of the Trusted Trade Alliance. David holds a PhD in Public Sector Management and has over 40 years' experience in international trade regulation, including 21 years with the Australian Customs Service. In 2019 he was appointed as a Member of the Order of Australia for significant service to higher education in the field of international trade and customs.

# Re-examining border clearance in the age of e-commerce

*Bryce C. Blegen*

## Abstract

---

Traditional customs clearance processes for goods arriving in ports or at border crossings involve declaration, inspection, revenue collection, and release procedures focused in time and space at the point of arrival. This paradigm for government management of cross-border trade in goods has been incrementally impacted in the 21st century by change drivers ranging from heightened concerns about security and safety risks in international supply chains to the increasingly sophisticated use of prearrival data collection and IT automation in border management processes.

Over the past decade, the rapid growth of online retailing, sometimes referred to as e-commerce, has led to an exponential increase in goods, often individually packaged, shipped directly from the seller to consumer. Existing border clearance models for international goods shipments were established in the context of an environment dominated by business-to-business commercial shipments of cargo for further distribution (for example, by retailers) in the country of destination. The rapidly expanding volume of cross-border direct-to-consumer shipments generates large numbers of small package consignments, presenting a challenge for existing goods clearance models in many countries. Contemporary border clearance processes may not be ideally suited to the rapidly expanding volumes of such shipments, and the limited reporting requirements often associated with such consignments may make effective risk management and revenue collection very difficult for governments.

Border management modernisation initiatives spearheaded by multilateral organisations have generated some clarity in confirming that e-commerce's effects do challenge traditional border clearance models, highlighting many of the underlying issues, but they have not generated a clear path forward on policy solutions. As a result, individual countries have been re-examining their national border clearance processes and are starting to take actions to tackle the e-commerce border clearance challenge on their own, highlighting the need for further multilateral work in this area to develop a consensus on policy measures to address the border management concerns identified.

---

## 1. Contemporary border goods clearance

Clearance processes for goods arriving in ports or at border crossings generally involve multistep declaration, risk analysis, inspection, revenue collection, and release procedures focused in time and space at the point of arrival of a shipment in the destination country (Pomerantz & Topik, 2018). In most countries, existing border clearance models for international goods shipments have developed in the context of a trading environment dominated in recent decades by business-to-business (B2B) commercial shipments of bulk, containerised or palletised cargo for further processing or distribution (for example, by retailers) in the country of destination (David, 2017). International trade in goods in today's global economy is largely based on standards set by multilateral post-World War II conventions and treaties (Organization for Security and Co-operation in Europe, 2012, pp. 10–29). The bulk of today's international trade takes place in a highly complex environment involving financial, fiscal, legal, logistical, and regulatory aspects, and the movement of a shipment from origin to destination typically involves a multiplicity of commercial and governmental actors who must perform a choreographed sequence of tasks to ensure the shipment's arrival. The 'Buy-Ship-Pay' model developed by the United Nations Economic Commission for Europe (UNECE) provides an easy-to-understand reference for how commercial trade happens and the categories of actors involved, which include a number of intermediaries and service providers (UNECE, 2012).

A very important step in this chain of events, and the one this paper is focused on, is the shipment's border clearance in the country of arrival, a task performed by the agency in the importing country charged with border management responsibility, often the national customs authority (UNECE, 2012). A commercial shipment's clearance in most cases requires submission of declaration data (whether in documentary or electronic form, sometimes well in advance of the shipment's physical arrival) to the responsible agency, which uses the data provided to determine whether duties, taxes or other fees are payable, whether other mandatory legal requirements apply, whether an inspection is required, and then issues a release for the shipment, which may occur in certain cases conditionally prior to full and final clearance. The efficiency and cost of border clearance has been widely recognised as a critical factor for the underlying business drivers of trade, and therefore for trade facilitation generally (McClinden et al., 2010, p. 90).

The prevailing paradigm of government regulation and management of cross-border trade in goods has been incrementally impacted since the inception of the 21st century by several interrelated factors driving change. Change drivers range from heightened policy concerns about security and safety risks in international supply chains (Urciuoli, 2018) to the increasingly sophisticated use of prearrival data collection and IT automation by governments. Innovation in national border clearance processes may also be driven by bilateral and multilateral arrangements, notably the Revised Kyoto Convention (RKC) (WCO, 2006) and the treaties administered by the World Trade Organization (WTO), including the recent WTO Agreement on Trade Facilitation (TFA) (WTO, 2017). National border clearance policies are further influenced by policy frameworks developed by the World Customs Organization (WCO), such as the SAFE Framework of Standards (WCO, 2005) and its associated security-focused documents and updates incorporated into the 'SAFE Package' (WCO, 2020a).

While these factors have led to modernisation and incremental innovation in the primarily commercial B2B-focused national border clearance processes for cargo over the past two decades, there has only recently been recognition that the rapid emergence of online commerce, especially direct business-to-consumer (B2C) commercial arrangements<sup>1</sup> generating a proliferation of cross-border parcel shipments, presents potentially significant management challenges to the prevailing border clearance processes in place in many countries.



## 2. E-commerce is driving broad policy changes

The advent of widespread use of the internet in the last decade of the 20th century facilitated a rapid expansion of online shopping, and augmented the traditional brick-and-mortar mode of retailing with a growing variety of internet-based ‘storefronts’ and marketplaces, sometimes referred to as the e-commerce ‘revolution’ (Burt & Sparks, 2003). This phenomenon has had widespread impacts on traditional distribution channels for goods (historically predicated on large-value B2B arrangements), and has led to a rapid increase in both lower value B2B as well as B2C transactions, with goods (as well as digital products and services) purchased online (sometimes via a third-party ‘platform’ website) and delivered directly from the source (for example, the seller) to the customer, individually packaged, and often utilising postal or other parcel delivery channels which bypass the more traditional B2B forms of distribution logistics (Organization for Economic Cooperation and Development, 2019).

While the rapid growth of e-commerce retail was initially focused within the domestic markets of major developed countries, the cross-border component is significant, and is growing at an even faster rate than the domestic component (United Nations Conference on Trade and Development, 2020a). Interestingly, research shows that direct-to-customer cross-border purchases may be a much more significant component of e-commerce activity (in those developing countries where border clearance is cost-effective) than in developed countries (KPMG International, 2017, p. 9), possibly because online sources provide access to an assortment of products which are otherwise not available via developing country domestic retail outlets. Recent reporting from the WTO (WTO Secretariat, 2020) and anecdotal reporting from private sector sources indicates that the rate of growth in the e-commerce retailing sector may have increased significantly as a consequence of the COVID-19 pandemic (Adobe, 2020; Goldman Sachs, 2020).

The rapid growth of e-commerce – generated economic activity over the last two decades has attracted the broad attention of global policymakers, both in domestic as well as multilateral contexts (Coppel, 2000). Two topical e-commerce – related policy discussions, both quite well-developed in terms of providing actionable guidance to policymakers, are particularly relevant for a re-examination of the phenomenon’s impacts on border clearance paradigms: consumption-based taxation and anticompetition. The former deals with taxes levied on consumer sales transactions, and unique collection challenges associated with the B2C context, while the latter focuses on the potential anticompetitive effects posed by the e-commerce phenomenon itself as well, as to concerns related to the role of the marketplace/platform operator vis-a-vis sellers and consumers. Both discussions merit a brief background overview of aspects relative to the border clearance context before we dive deeper into that in the next section.

Most national revenue systems had some form of consumption taxation on commercial sales transactions prior to the advent of widespread online sales, often a form of value-added/goods and services (VAT or GST) or sales tax, the burden of which ultimately falls largely on the consumer/purchaser of the product (whether a good or a service). This tax is generally collected by the commercial parties involved in the transaction (typically distributors and retailers), who are obligated to register with the government and periodically remit the tax collected (Charlet, 2010). In most jurisdictions with a VAT/GST, this type of tax is also applied to imports, and collection is handled as part of the import process (Organization for Security and Co-operation in Europe, 2012, p. 106): for many developed countries import VAT/GST is a much more significant source of revenue than are import customs duties.

The change in the traditional retail paradigm associated with the move to e-commerce and online marketplaces (sometimes with a large number of sellers operating in a virtual mode) highlighted a number of challenges for revenue authorities in determining, applying and collecting such taxes. These challenges are heightened in international markets and in places where tax rates applicable may vary from place to place within a multistate domestic market (as in the United States) or in a multicountry

common market such as the European Union (EU). The challenges also apply to cases where the parties acting as seller, distributor and buyer may be geographically dispersed or involve B2C transactions with consumers in configurations not conducive to effective collection of taxes due. These issues and their implications for policy have been widely discussed and addressed in the context of the United States (US) domestic (Gamage et al., 2019) and EU common markets (Deloitte and European Commission, 2015). The need to address e-commerce – related tax issues at the international level is increasingly dominating the attention of the Organisation of Economic Cooperation and Development (OECD) as an essential component in forward-looking multilateral tax policy strategies among the world’s most developed economies (OECD, 2015). A report admirably addressing the VAT/GST revenue collection challenges related to online platform sales, together with potential policy options moving forward—many of them directly relevant and closely linked to any re-examination of the border clearance process—was recently published (OECD, 2019).

The global success and rapid expansion of online e-commerce giants such as Amazon, Ebay, and others has also generated concerns related to anticompetition policy. Online platforms operate as ‘two-sided markets’ (Rochet, 2003), as intermediaries between suppliers/sellers and customers/consumers, a phenomenon long identified as having implications for the regulation of fair competition (Evans & Schmalensee, 2013). An online platform may be structured as a ‘marketplace’, a forum for independent sellers and buyers to do business, or also be engaged directly in selling on its own behalf (potentially competing with independent sellers using the same marketplace), as well as providing related services involving delivery (Hagiu & Wright, 2015). In recent years, the success of B2C-focused web storefronts in gaining a dominant role (Stoller, 2019, p. 444) in online retailing, and leveraging that role to expand into related sectors, notably including order fulfilment and related logistics services, has generated much attention and motivated the close attention of policymakers (Crémer, 2019).

Specifically, the ability of major online platforms to function as a ‘gatekeeper’, as well as to exert a significant level of control (for example, via contractual terms and conditions) over suppliers utilising their marketplace as well as on consumer/purchasers has been studied and noted as raising anticompetition concerns (Khan, 2018). It has been given high priority in policymaker circles in the European Union (European Commission, 2020). Further, the ability of the platform to control delivery (via provision of logistics services and leveraging the associated control over logistics providers) has been noted as a potential source of anticompetitive outcomes, as has the ability of the platform to collect, amalgamate and utilise to its own advantage the universe of data (whether originating from suppliers, customers, or its control of the origin-to-destination supply chain) generated across the entirety of its business (Khan, 2017). These considerations are directly relevant for any re-examination of border clearance – related policy options to address the e-commerce challenge.

### 3. E-commerce and border goods clearance

Before we move on to discuss the challenge to cross-border goods clearance paradigms presented by e-commerce – generated shipments, it is important to define the limits of the concept of ‘e-commerce’ in terms of its border clearance – related scope. It is surprisingly difficult to find a generally accepted, everyday definition of ‘e-commerce’. One useful one which has been widely cited is ‘doing business over the Internet, selling goods and services which are delivered offline as well as products which can be ‘digitised’ and delivered online, such as computer software’ (Coppel, 2000); a more refined definition comes from the broader work of the OECD, an organisation which has done a great deal of work on investigating the economic and tax-related implications of e-Commerce. The OECD definition is:

An e-commerce transaction is the sale or purchase of goods or services, conducted over computer networks by methods specifically designed for the purpose of receiving or placing of orders. The goods or services are ordered by those methods, but the payment and the ultimate delivery of the

goods or services do not have to be conducted online. An e-commerce transaction can be between enterprises, households, individuals, governments, and other public or private organisations. To be included are orders made over the web, extranet or electronic data interchange. The type is defined by the method of placing the order. To be excluded are orders made by telephone calls, facsimile or manually typed email (OECD, 2002).

Both the above definitions of the e-commerce concept are equally applicable to online shopping in the domestic, international, or cross-border environment. It is, however, essential to note here that the products in this definition's scope can be tangible or intangible (for example, involving data or software), and either goods or services. E-commerce is embedded within the larger concept of digital trade, which encompasses digitally delivered software, e-books, data or database services as well as (digitally enabled) transactions leading to physically delivered goods and services (López González & Jouanjean, 2017). Because contemporary border clearance paradigms are currently focused on tangible goods only, this paper is primarily focused on that component of the larger e-commerce transaction universe which results in the physical movement of tangible goods from one country, across one or more national borders, into another country.

As we noted at the outset, the dominant model of border goods clearance evolved in an international trading environment primarily focused on B2B transactions, often involving bulk, containerised or palletised cargo shipments of considerable volume and value, travelling in the maritime, land transport, or air cargo modes. For the sake of convenience, we will refer to these as 'standard cargo' shipments, cleared at the border through what we will refer to as the 'standard cargo channel'. Over the past two decades, this channel has been the subject of much attention in terms of border management policy and the operational priorities of border agencies.

The WCO, with a membership comprising the customs and border management agencies of most countries around the globe, is uniquely focused on the border clearance process, in particular that relating to international trade in goods. It counts among its evolving missions (Widdowson, 2007) the development of international standards to support its members in building their capacity to achieve customs goals such as facilitating legitimate trade, securing revenue collection, and protecting society (WCO, 2020b). The WCO is responsible for administering the RKC (WCO, 2006), an international convention focused on customs procedures, including those related to border clearance, which has been acceded to by the majority of its member countries. The WCO has launched numerous initiatives over the past two decades, many aligned closely with its 'Customs in the 21st Century' framework (WCO, 2008), to assist its member countries in enhancing border management capacity to handle higher trade volumes while better targeting potential security, safety, and traditional enforcement issues (such as collection of customs duty and tax revenue on imports). The WCO approach is advance data driven, demands enhanced intra- as well as intergovernmental operational coordination to manage cross-cutting safety and compliance mandates, and presupposes significant upgrades in information technology (IT) among its members to enable effective use of data-driven automated risk management on cross-border goods consignments. The WCO's approach for modern border management is largely aligned with guidance from experts and multilateral organisations, including the World Bank (De Wulf & Sokol, 2005; McInden et al., 2010), and also has much in common with the principles of the recent WTO TFA (WTO, 2017), a treaty binding on the large majority of WTO (and WCO) member countries which have ratified it.

It is, however, important to note that virtually all countries have at least two broadly delineated border clearance regimes. These regimes can be categorised as channels, applicable for the declaration, inspection, revenue collection, and clearance of inbound cross-border goods shipments—the first, noted above, for standard cargo shipments (whether containerised or not, via the various transport modes), generally B2B in nature and of significant value or volume. This standard cargo channel is the one which has been in primary focus under the multilateral initiatives referenced in the previous paragraph, and in

national modernisation initiatives affecting border clearance processes. A second channel, which often has separate subvariants in each country for defined shipment categories, for example postal and courier, (OECD, 2015, p. 192) is referred to here for convenience as the ‘parcel clearance channel’ or ‘parcel channel’. Shipments accessing the parcel clearance channel are often postal or express courier deliveries of a value below a defined threshold (often referred to as ‘*de minimis*’), and with characteristics (for example, size, weight) which do not otherwise disqualify them under applicable national restrictions from using this channel (OECD & EU IPO, 2018, pp. 17–24). In most cases, countries initially introduced international parcel delivery under their accession to the Universal Postal Union (UPU), under terms aligned with that organisation’s binding conditions and standards, which have specific provisions governing international parcels (UPU, 2020). As a result, international parcels (delivered via postal or other, for example, express courier avenues) destined to consumer (or business) addressees have long been an option for deliveries to most countries (WTO Secretariat, 2010), both for noncommercial (for example, personal gifts) and for commercial (B2B & B2C) purposes.

Often noncommercial, usually low-value, and in many cases, destined for delivery directly to a consumer, international parcel shipments were seen by policymakers in decades past as of lower priority in terms of customs duty/tax revenue. As the cost and bother of putting them through a standard customs border clearance process could greatly outweigh the potential return (Hintsa et al., 2014), special clearance treatment could be justified. As a consequence, many international postal or express courier shipments are processed through the parcel border clearance channel, thereby enjoying streamlined clearance procedures (often involving simplified declarations) requiring notably less documentation and data than would be applied to a shipment using the standard channel in the same country (Holloway & Rae, 2011). They often further benefit from national ‘*de minimis*’ provisions involving duty- and tax-free treatment (Global Express Association, 2019). Lending conceptual support and operational guidance to this second, parcel-focused clearance channel, the WCO has issued guidelines (WCO, 2018a) for its member countries encouraging the expedited release of eligible international shipments, and Article 7 of the WTO’s Trade Facilitation Agreement also incorporates provisions related to the streamlined release of eligible ‘expedited shipments’ (WTO, 2017) applicable to the parcel clearance channel.

While shipments cleared through standard cargo channels have been, and indeed remain, the predominant factor (by volume and value) in goods trade statistics (UNCTAD, 2016), the growth rate of parcel shipments in both domestic and international contexts over the past several years has been relatively higher, growing to a total of an estimated 87 billion parcel shipments globally by 2018 (Pitney Bowes, 2019). From a border clearance perspective, the parcel clearance channel is the one which has been primarily impacted by the explosion of shipments, many B2C in nature, generated by e-commerce merchandising. In light of the availability in most countries of a parcel border clearance channel offering expedited border clearance with streamlined declaration requirements, and furthermore, in many cases offering preferential import duty and VAT/GST tax treatment, it is not surprising that e-commerce retailers have elected to take advantage of this channel for international B2C deliveries, driving exponential growth in parcel volumes (US Customs and Border Protection, 2018). It is also not surprising, perhaps, that this exponential growth has led to a recent wave of concerns among border authorities and in the press that e-commerce – driven growth in international parcel shipments is accompanied by the widespread and unauthorised use of the parcel clearance channel to import dangerous, unauthorised, high-value, counterfeit (OECD & EUIPO, 2018), or otherwise illicit, goods (Horwitz, 2019). This is a situation which governments recognise as a significant challenge (US CBP, 2018, p. 4). The rapid increase in cross-border online sales leading to direct B2B or B2C deliveries has also led to a recognition in government circles that widespread (and sometimes creative) use of available *de minimis* arrangements in the parcel channel (OECD, 2015, p. 120) can lead to a significant loss of import-related revenue and create distortive competitive effects (European Court of Auditors, 2019).

On its main ‘Cross-Border e-Commerce’ webpage (WCO, 2020c), the WCO lists the following three main categories of e-commerce – related ‘Challenges faced by Customs administrations’:

- trade facilitation and security
- fair and efficient collection of duties and taxes
- protection of society—criminal exploitation of e-commerce.

Regarding the first category, specific concerns listed include:

- ensuring speed and efficiency in the clearance process for an increasing volume of transactions
- managing change from a few large/bulk shipments into many low-value and small shipments
- managing risks posed by limited knowledge on importers and the e-commerce supply chain (new class of sellers and buyers/occasional shippers and buyers)
- ensuring data quality (accuracy and adequacy of the data received)
- defining the role and responsibility (liability) of e-commerce operators to assist governments (e-vendors/intermediaries).

These concerns appear to stem largely, directly or indirectly, from a combination of factors unique to direct international retail sales (in particular B2C sales) and the differential border clearance treatment granted to shipments using parcel clearance channels. Border clearance-related concerns do not appear to be connected to the online nature of e-commerce per se, but rather to the vastly increased volume of the direct international shipments generated by it. Indications are that while the standard cargo channel in many countries has been updated in recent decades to take account of modern advance data-focused border management practices (for example, those incorporated in the WCO ‘Customs in the 21st Century’ framework referenced previously), the parcel clearance channel, in particular as it relates to postal shipments, often relies on older processes from the 20th century. This factor, along with simplified declaration requirements associated with many *de minimis* regimes (GEA, 2019), makes risk management by border management authorities difficult, in part due to the limited availability of shipment-related data (whether received in advance electronic form or not). As a result, enforcement of parcel clearance channel eligibility criteria or discovery of illicit parcel contents by means other than direct physical inspection may be impractical, especially as parcel volumes increase.

The flexible allocation of roles and responsibilities which characterises cross-border e-commerce configurations, with sellers/platform operators in one (or more) country/countries and the customer in another, may not always be in alignment with longstanding national legal provisions defining import-related roles and responsibilities, particularly in the B2C context.<sup>2</sup> These legal regimes, developed and optimised for the standard cargo channel and the B2B commercial environment, set the framework for assigning import clearance-related revenue and compliance liability (for example, accuracy in declarations, compliance with parcel channel restrictions, and mechanisms for revenue collection). They may not be clearly applicable (opening the door to evasion) nor practically enforceable for shipments using the parcel channel, even where infractions are identified at or after the time of clearance. Similar concerns have been cited and extensively analysed in relation to VAT/GST revenue collection in the cross-border e-commerce context, underlining the need to take them into account in policy measures addressing the cross-border challenges presented by the growth in e-commerce (OECD, 2019).

## 4. E-commerce and border clearance: multilateral efforts

Recognising that the proliferating volume of international shipments generated by e-commerce sales was creating border clearance challenges for governments, several multilateral organisations have embarked on initiatives, all ongoing, to assist their member countries in analysing e-commerce – related challenges and developing effective and implementable policy responses. The WTO has had a focus on e-commerce since 1998, recognising that it could be a positive factor in the global growth of trade. It has a web portal (WTO, 2020) tracking the history of its relevant activities, among others, the moratorium, in place since 1998 and last renewed in late 2019 (Congressional Research Service, 2020) on the imposition of customs duties on electronic transmissions. This is generally interpreted to include digital products such as digital music, videos, videogames and the like. Recognising the increasing importance of e-commerce in global trade, a number of key WTO member countries issued a joint statement (WTO Member Delegations, 2019) calling for negotiations on trade-related aspects of electronic commerce. While discussions have been delayed for a number of reasons, including the COVID-19 crisis, and have not yet led to consensus outcomes, this topic is seen as a high priority for the WTO Secretariat, which recently issued an update on the topic (WTO Secretariat, 2020).

The OECD has had a focus on e-commerce, and its implications for policymakers, for the last two decades (Coppel, 2000), primarily in the context of taxation and associated revenue collection policies and practices, but also extending to areas of enforcement concern such as counterfeit goods (OECD & EUIPO, 2018). Its earlier work in the area of VAT/GST collection on imports of low-value goods (OECD, 2015, pp. 181–208) has been expanded more recently (OECD, 2019) and is highly relevant to the border clearance context. In particular, it is relevant in relation to policy decisions for effective revenue collection options in B2C configurations, taking account of the various roles (in particular, the role of platforms) and their implications for effective revenue collection in the e-commerce supply chain.

As the multilateral body tasked with coordination and administration of the RKC, the primary convention governing customs procedures (WCO, 2006), it became increasingly clear within the WCO that the e-commerce revolution necessitated a re-examination of border clearance processes in a broader sense, not just in relation to import revenue collection. In response, the WCO set up a Working Group on E-commerce (WGEC) in 2016, and the WCO staff developed a ‘Study Report on Cross-Border E-Commerce’ (WCO, 2017a), derived in part from the results of a survey of members. The WCO Policy Commission subsequently issued a resolution (‘Luxor Resolution’) outlining governing principles (WCO, 2017b) to guide the organisation’s e-commerce work. The WGEC, a group of volunteers, was open to participation by WCO member country customs administration officials, representatives of the global private sector trade community, other multilateral organisations, e-commerce stakeholders (these included some of the major e-commerce platform operators) and academia, with an ambitious mission ‘to develop collaborative solutions supporting the needs and expectations of all stakeholders in the E-Commerce supply chain’ (WCO, 2018b, p. 3).

The WGEC and its subgroups met multiple times through early 2020, and played the initial role in formulating the WCO Cross-Border Framework of Standards (‘Framework’) which was adopted by the WCO Council (WCO, 2018b). The Framework is comprised of introductory material and 15 ‘standards’ arranged under eight categories referencing and largely (but not entirely) aligned with the eight ‘principles’ set out in the Luxor Resolution. The Framework is complemented by a more extensive Technical Specifications document (WCO, 2019a), containing a large number of ‘technical specifications’ categorised under the 15 standards from the Framework, as well as a brief ‘Definitions’ document. These, along with other documents designed to augment and support the Framework, were published as part of a larger compendium known as the WCO E-Commerce Package (‘E-Commerce Package’) with several other supplementary documents in 2019 (WCO, 2019b).

The Luxor Resolution's list of 'principles' is addressed to customs and border management authorities, and includes many clearly prescriptive statements to address their priorities, some phrased as requirements, for dealing with e-commerce – related challenges (which, while not specifically listed in the Luxor Resolution, roughly correspond to the WCO 'Challenges faced by Customs administrations' cited in the previous section above). In contrast, the Framework provides broad-based descriptive and background information relevant to e-commerce in the cross-border context, and its 'standards' are characterised by the use of much softer and more aspirational language (for example, 'should explore', 'should consider') (WCO, 2018b, pp. 14–15), encouraging a balancing of interests among 'E-Commerce stakeholders'. This tone is also carried over to the Technical Specifications document (WCO, 2019a), which is focused on providing additional background and guidance for each 'standard'. The Technical Specifications, while somewhat more prescriptive than the Framework, also rarely rise to the level of prescription contained in the Luxor Resolution. While both the Framework and the Technical Specifications mention the RKC, the WTO and 'international organisations' in passing, and sometimes refer to existing guidelines of the WCO or other international bodies, they do not cross-reference either the 'standards' or the 'technical specifications' to specific prescriptions of binding multilateral arrangements (for example, the WTO Trade Facilitation Agreement, the RKC, and the UPU Convention) or to relevant specific policy recommendations of the OECD or UN agencies such as UNCTAD (UNCTAD, 2020b). This factor, in combination with the sometimes broad and aspirational nature of the 'standards' and 'technical specifications', may present a challenge for policymakers in deriving practical and actionable options for e-commerce – related border clearance policy at the national level.

Further challenges in the practical application of the Framework and the Technical Specifications are definitional in nature. The 'Definitions' document contained in the Package (WCO, 2019b) contains four defined terms, including *inter alia* the following:

Cross-Border E-Commerce: All transactions which are effected digitally through a computer network (e.g., the internet), and result in physical goods flows subject to Customs formalities.

This definition goes to the heart of the matter, the universe of transactions to which the Framework and the Specifications are intended to apply. The Luxor Resolution indicates a primary (but not exclusive) focus on 'business-to-consumer (B2C) and consumer-to-consumer (C2C) transactions' (WCO, 2017b, p. 1), while the relevant wording in the Framework (WCO, 2018b, p. 8) 'characterises' its subject along those same lines, as follows:

For this Framework of Standards, cross-border E-Commerce is characterised as follows:

- Online ordering, sale, communication and, if applicable, payment
- Cross-border transactions/shipments
- Physical (tangible) goods
- Destined to consumer/buyer (commercial and noncommercial).

This Framework sets standards mainly for B2C and C2C transactions. However, Members are encouraged to apply the same principles and standards to business-to-business (B2B) transactions.

Going back to the Package's 'Definitions' document, however, and its definition of 'Cross-Border E-Commerce' cited above, it is notable that it does not mirror the Luxor Resolution's stated primary purview of B2C and C2C transactions, nor the Framework's 'characterisation' which mentions B2B transactions as well. Instead, the definition's first focus is on broadly defining the transactions in scope, as being 'effected digitally through a computer network (e.g., the internet)', with the second clause capturing the 'cross-border' aspect by adding the condition '...and result in physical goods flows subject to Customs formalities.' This definition is not in line with widely used definitions of 'e-commerce', such as the widely accepted OECD definition (OECD, 2002) for an e-commerce transaction discussed

in an earlier section ('...sale or purchase of goods or services, conducted over computer networks by methods specifically designed for the purpose of receiving or placing of orders'). The 'Definitions' document's wording replaces 'conducted' with 'effected' and dispenses with the 'sale or purchase' and 'receiving or placing orders' aspects at the core of the OECD definition. Why this is the case is not clear, but it does appear to have the effect of broadening the coverage of 'Cross-Border E-Commerce' under the Framework and Package to encompass *any* transaction (commercial or not) 'effected digitally' (the meaning of 'effected' is not itself defined) which 'results in physical goods flows subject to Customs formalities' ('subject to Customs formalities' is also not itself defined).

The Framework and the larger set of documents encompassing the Package do not otherwise attempt to strictly differentiate 'Cross-Border E-Commerce' goods flows from other cross-border goods flows, whether by reference to a breakdown by standard cargo/parcel clearance channels (for example, as discussed elsewhere in this paper) or by reference to pre-existing WCO instruments. While the Luxor Resolution mentions 'issues stemming from...mainly small B2C and C2C E-Commerce shipments' and the need to deal 'with the increasing volumes of small shipments/parcels' (WCO, 2017b, pp. 1, 4), it does not otherwise define what constitutes 'small', nor does it reference shipment value as a defining criterion. The Framework also infrequently references 'small' or 'smaller' consignments or shipments as being in focus, usually adding the qualifier 'low-value' as well (WCO, 2018b, pp. 9, 14–15). The 'Definitions' document, cited above, does provide a definition for 'low-value shipment' as those 'Goods classified under categories 2 and 3 in the WCO Guidelines for the Immediate Release of Consignments by Customs', these being defined in that document (WCO, 2018a, p. 3) as:

Category 2 — Low-value consignments for which no duties and taxes are collected (*de minimis* threshold)

Category 3 — Low-value dutiable consignments (simplified declaration)

As such, the 'low-value shipment' definition appears to be a flexible concept varying according to national law, in line with national *de minimis* provisions. Nevertheless, as the defined 'low-value shipment' term is rarely referenced in either the Framework or the Specifications, and has no explicit linkage to the primary 'Cross-Border E-Commerce' definition, it is not useful in elucidating the intended scope of cross-border clearance activity addressed by the Framework and the larger Package.

In sum, as per the 'Definitions' wording, as long as 'physical goods flows subject to Customs formalities' arise from a transaction which is 'effected digitally through a computer network', the respective shipments would appear to be deemed 'Cross-Border E-Commerce' in scope of the Framework and Package, regardless of mode, clearance channel, underlying category (for example, B2B or B2C), value or size. In light of the advanced level of computerisation utilised in both private- as well as public-sector aspects of international trade, it seems probable that virtually all cross-border consignments in 2020 arise in some way from transactions utilising computer networks, and are thereby arguably 'effected digitally'. This implies that virtually every cross-border shipment is within the scope of the Framework and its supporting documents. It is not clear whether the WCO's intent in launching its e-commerce initiative (ostensibly tailored to challenges related to the exponential growth of e-commerce) was that the outcomes, (for example, the Framework and other documents in the Package) should be overlaid on the WCO's large body of existing instruments related to the 'Customs in the 21st Century' framework, including those dealing up to now primarily with shipments being cleared through what we have referred to as the standard cargo channel. Nevertheless, in light of the above definitional aspects of the Package, the texts of the key documents resulting from the WCO's e-commerce efforts so far leave the door open to the interpretation that they are intended to be applied to virtually all cross-border goods trade.

Clearly, the WGEC's proceedings served to identify a number of critical e-commerce – related border clearance issues and focus areas to be addressed, and the documents of the Package provide a compendium of information and considerations which are useful for policymakers re-examining existing processes



in light of the proliferation of e-commerce – generated shipments requiring clearance. Nevertheless, the absence of a clearly delineated scope of application of the Framework and Package, together with the largely missing direct alignment with and cross-referencing to prescriptive and binding instruments (for example, the RKC, UPU Convention<sup>3</sup> or the WTO Trade Facilitation Agreement) and the relevant work of other international organisations (for example, the OECD) combines with their largely aspirational tone to make them sometimes insufficient in providing actionable policy guidance to national border management authorities. Without going into an in-depth examination of the deliberations of the WGEC and the proceedings of the WCO’s governing bodies, it is impossible to identify the full scope of what was considered, the policy options that were looked at, and to determine why the documents published as outcomes are not as clearly focused as, for example, the SAFE Framework (WCO, 2005) was, even in its first version. Perhaps the WGEC’s stated mission (‘to develop collaborative solutions supporting the needs and expectations of all stakeholders in the E-Commerce supply chain’) (WCO, 2018b, p. 3) was simply too broad to deliver clearly prescriptive consensus outcomes from such a diverse base of stakeholder interests.

It appears that it may have been this difficulty in achieving consensus which led to the WCO Policy Commission and Council failing to endorse three important planned 2019 Package documents addressing guidance for three rather critical e-commerce – related areas of concern, those being ‘Reference Dataset for E-Commerce’, ‘Revenue Collection Approaches’, and ‘E-Commerce Stakeholders: Roles and Responsibilities’. As a result, the WGEC was called back in early February of 2020 to hold a final session to further consider these documents, prior to their submission for approval by the WCO governing bodies (the documents had not yet been published as part of the Package as of the date of this writing). The WCO has indicated that it intends to continue e-commerce – related work under the auspices of its Permanent Technical and Enforcement Committees in future (WCO, 2020d).

## 5. Emerging national initiatives

While actively involved in the multilateral discussions which led to publication of the WCO’s Framework and Package, several major trading economies began efforts to re-examine e-commerce – related challenges in the context of their own national border clearance processes, with resulting initiatives beginning to be announced at about the same time as the Framework was being completed. In late 2017, Australia announced a number of legislative changes related to implementation of the collection of GST revenue on ‘Low-Value Goods’ as defined under Australia’s pre-existing *de minimis* arrangement (the associated exemption for customs duty was, however, retained), extending its tax-registration requirements to certain nonresident e-commerce suppliers/platforms, imposing GST collection obligations on them, and instituting modified information requirements (OECD & EUIPO, 2018, p. 24). This initiative was launched after a government-commissioned comprehensive analysis (Australian Government Productivity Commission, 2017) of e-commerce business models, roles and responsibilities, operational realities in border clearance, and available collection models, conducted in line with principles adapted from the OECD policy analysis framework (OECD, 2015).

Motivated by the rapid growth of cross-border e-commerce, and with a desire to preserve e-commerce – generated economic growth while at the same time fostering an EU-wide level playing field, the EU Commission embarked on a wide-ranging examination of policy options (Deloitte and European Commission, 2015), including in relation to effective import VAT/customs duty collection (European Court of Auditors, 2019). These efforts culminated in a series of legislative and regulatory changes which are scheduled for full implementation in 2021 (Papis-Almansa, 2019). These changes involve innovative provisions dealing with import VAT collection (including registration and remittance of VAT by intermediaries and seller/platforms outside the EU) and harmonisation and limitation of pre-existing *de minimis* exemptions for VAT and customs duty on imports. They also involve new, stricter,

reporting and declaration procedures designed to enable governments to better enforce revenue and other import compliance requirements (EU Commission, 2019) which are particularly relevant to low-value shipments utilising the parcel clearance channel.

The US has seen rapid growth in e-commerce – related parcel imports, especially since the 2015 enactment of an expanded *de minimis* duty exemption for directly delivered B2C consignments (Gillis, 2019). This, combined with pre-existing simplified declaration requirements for certain types of low-value consignments, made importation via the parcel channel quite attractive for e-commerce retailers (US CBP, 2018, p. 4). In response to concerns related to evidence of abuse of this channel for ‘illicit drugs, items that infringe on intellectual property rights, and other dangerous goods’ (US CBP, 2018, p. 6), the US border management agency developed a strategy (US CBP, 2020a) to address the situation, primarily through means of improved risk management through enhanced consignment-related advance data as well as heightened enforcement authority (Presidential Executive Order, 2020). As part of this strategy, the US has instituted a pilot project to collect consignment-related advance data from major e-commerce players, including platform operators and express forwarders (US CBP, 2020b).

The above list is not exclusive; other countries from China (Yu, 2018) to New Zealand (Satherley, 2019) are actively re-examining their border clearance procedures to address e-commerce – related challenges, and many are implementing policy responses which have yet to be fully rolled out. In some countries, particularly those with a VAT/GST on imports, the primary motivation for these initiatives is clearly more effective revenue collection and preserving a level competitive playing field with retailers (whether online or brick-and-mortar) in the domestic environment, while in others (for example, the US, which does not have a VAT tax) it is primarily preventing the introduction of illicit (for example, counterfeit or prohibited) goods. Regardless of the underlying primary motivation, all of these national initiatives are also focused, at least in substantial part, on controlling misuse of the parcel clearance channel and associated national *de minimis* provisions. This is achieved through a combination of enhanced requirements for the provision of (advance) shipment data and establishment of registration, reporting, and revenue collection methods tailored to e-commerce business models, and applied to platform operators or other intermediaries involved in the e-commerce supply chain.

## 6. Prospects for progress

The growing number of e-commerce – related multilateral and national policy initiatives, including those noted above, demonstrate that the e-commerce revolution is generating consequences which are driving broad policy changes, some beginning to directly impact clearance-related processes for cross-border goods movements. More broadly, e-commerce – related developments touching on competition and taxation policy, the latter particularly in relation to VAT/GST, have been the subject of much study and analysis, leading to a growing and multilateral consensus on available options for policymakers. In both fields, studies have collected detailed information on the roles and responsibilities of sellers, platform operators, consumers and other e-commerce actors, and identified policy options capable of addressing government priorities (for example, collecting tax revenue owed, and preventing anticompetitive practices) without unduly impeding e-commerce. These studies, along with policy options and government initiatives derived from them, cover a wide range of economic activity, but a significant number of them are directly relevant to the cross-border goods context, and often explicitly address issues related to border clearance (for example, means of controlling market access, data collection capabilities, modes of revenue collection on imports, and enforcement considerations).

Against this broader backdrop, the analysis of e-commerce in the border clearance context is by its nature a narrower one. As previously noted, most cross-border trade in goods is B2B in nature, and uses standard cargo channels. Whether that trade arises in an online commercial environment or not, the cargo flows that result are handled using established (standard channel) clearance procedures at the national

level, usually in accord with standards set by the RKC and informed by WCO initiatives linked to the ‘Customs in the 21st Century’ framework. Notably, the e-commerce – related border concerns which are cited in this paper, and which the national initiatives outlined above are ostensibly intended to address, do not seem to arise from standard cargo, the dominant subset of cross-border goods trade (the absence of standard cargo channel-related measures in the national e-commerce – related initiatives outlined in the previous section can be seen as evidence of this). Instead, the e-commerce – related concerns in focus for border clearance policymakers appear tied, in a very large part if not entirely, to cross-border commercial consignments generated by online ordering mechanisms, usually B2C in nature, usually packaged in parcels, addressed for direct delivery by a foreign party to a named recipient in the destination country, and which utilise (legitimately or not) a nationally defined parcel clearance process (and often claiming *de minimis* treatment).

In light of the multilateral and national efforts undertaken so far, e-commerce – focused border clearance challenges and concerns appear to arise in part from the need to adapt existing import clearance frameworks to the flexible and shifting roles and responsibilities associated with e-commerce sales, and in part to risk assessment and enforcement difficulties associated with parcel clearance channel procedures (including simplified data requirements and national *de minimis* provisions) in a high-volume environment. If that is the case, a path forward to develop policy options addressing the first category of concerns might be to apply deeper analysis of e-commerce – related roles and responsibilities (for example, as was done in the OECD, EU, and Australian studies cited previously) to the specific context of the parcel clearance environment and its underpinnings in binding international instruments like the UPU Convention and the RKC. The second category of concerns is to an extent already being addressed by national and multilateral efforts (for example, the WCO-UPU joint effort) to obtain better data for risk management earlier, but might also benefit from further examination of data sourcing and control in the platform/seller environment. For both categories, the goal should be to identify innovative and widely implementable policy options which take account of the business realities of cross-border e-commerce and address the concerns and challenges within the border clearance framework set by applicable binding international conventions (for example, RKC, the WTO Trade Facilitation Agreement, and the UPU Convention) and standards and best practices identified by the WCO. Options should also be informed by and aligned with initiatives to address e-commerce – related VAT/GST and anticompetition concerns, since border clearance-related measures will need to be compatible with them to be implementable.

The WCO’s focus on operational border management issues, together with its role in administering the RKC, would appear to put it at the centre of any multilateral effort to continue to re-examine the above challenges and concerns and refine border clearance-related policy options to address them. Its work to date on the Framework and broader Package give a broad knowledge base to work with in moving forward. As the WCO’s work on e-commerce continues, consideration should be given to narrowing the scope of work specifically to address governmental e-commerce – related challenges and concerns in the context of parcel clearance, to adopting e-commerce – related analytical frameworks developed in the competition and tax policy sectors, and to ensuring ongoing alignment with the e-commerce – related initiatives of the OECD, the WTO and other multilateral organisations.

## References

- Adobe. (2020). *Adobe Digital Economy Index*. Retrieved from [https://www.adobe.com/content/dam/www/us/en/experience-cloud/digital-insights/pdfs/adobe\\_analytics-digital-economy-index-2020.pdf](https://www.adobe.com/content/dam/www/us/en/experience-cloud/digital-insights/pdfs/adobe_analytics-digital-economy-index-2020.pdf)
- Australian Government Productivity Commission. (2017). *Collection Models for GST on Low Value Imported Goods*. Canberra: Government of Australia. Retrieved from <https://www.pc.gov.au/inquiries/completed/collection-models/report/collection-models.pdf>
- Burt, S., & Sparks, L. (2003). E-commerce and the Retail Process: A Review. *Journal of Retailing and Consumer Services*, 10, 275–286.
- Charlet, A., & Owens, J. (2010). An International Perspective on VAT. *Tax Notes International*, 59(12), 943–954. Retrieved from <https://www.oecd.org/ctp/consumption/46073502.pdf>
- Coppel, J. (2000). *E-Commerce: Impact and policy challenges*. Paris: OECD. Retrieved from [http://www.oecd.org/officialdocuments/publicdisplaydocumentpdf/?cote=ECO/WKP\(2000\)25&docLanguage=En](http://www.oecd.org/officialdocuments/publicdisplaydocumentpdf/?cote=ECO/WKP(2000)25&docLanguage=En)
- Crémer, J., de Montjoye, Y-A., & Schweitzer, H. (2019). *Competition Policy for the Digital Era*. Brussels: European Commission. Retrieved from <https://ec.europa.eu/competition/publications/reports/kd0419345enn.pdf>
- Congressional Research Service (CRS). (2020). *World Trade Organization: Overview and Future Direction*. Washington, DC: US CRS. Retrieved from <https://fas.org/sgp/crs/row/R45417.pdf>
- David, P. A. (2017). *International Logistics: The Management of International Trade Operations* (5th ed.). Cicero Books, LLC.
- De Wulf, L., & Sokol, J. B. (2005). *Customs Modernization Handbook*. Trade and Development. Washington, D.C.: World Bank. © World Bank. <https://openknowledge.worldbank.org/handle/10986/7216> License: CC BY 3.0 IGO.
- Deloitte and European Commission. (2015). *VAT Aspects of Cross-Border E-commerce: Options for Modernization*. Brussels: EU Commission. Retrieved from [https://ec.europa.eu/taxation\\_customs/sites/taxation/files/vat\\_aspects\\_cross-border\\_e-commerce\\_final\\_report\\_lot2.pdf](https://ec.europa.eu/taxation_customs/sites/taxation/files/vat_aspects_cross-border_e-commerce_final_report_lot2.pdf)
- European Commission. (2019). *New form of customs declaration for low value consignments*. Brussels: European Commission. Retrieved from Taxation and Customs Union News: [https://ec.europa.eu/taxation\\_customs/news/new-form-customs-declaration-low-value-consignments\\_en](https://ec.europa.eu/taxation_customs/news/new-form-customs-declaration-low-value-consignments_en)
- European Commission. (2020). *Digital Services Act package – ex ante regulatory instrument of very large online platforms acting as gatekeepers*. Brussels: European Commission. Retrieved from <https://ec.europa.eu/info/law/better-regulation/have-your-say/initiatives/12418-Digital-Services-Act-package-ex-ante-regulatory-instrument-of-very-large-online-platforms-acting-as-gatekeepers>
- European Court of Auditors. (2019). *E-commerce: many of the challenges of collecting VAT and customs duties remain to be resolved*. Luxembourg: European Court of Auditors. Retrieved from [https://www.eca.europa.eu/Lists/ECADocuments/SR19\\_12/SR\\_E-COMMERCE\\_VULNERABILITY\\_TO\\_TAX\\_FRAUD\\_EN.pdf](https://www.eca.europa.eu/Lists/ECADocuments/SR19_12/SR_E-COMMERCE_VULNERABILITY_TO_TAX_FRAUD_EN.pdf)
- Evans, D., & Schmalensee, R. (2013). *The Antitrust Analysis of Multi-Sided Platform Businesses*. National Bureau of Economic Research, Inc., Working Paper No. 18783. Retrieved from <https://www.nber.org/papers/w18783.pdf>
- Gamage, D. S., Shanske, D., & Thimmesch, A. (2019). Taxing E-Commerce in the Post-Wayfair World. *Washington University Journal of Law & Policy*, 58(1), 71–94.
- Gillis, C. (2019, 9 December). *CBP expands e-commerce data pilot to ocean, international mail*. Retrieved from American Shipper. <https://www.freightwaves.com/news/cbp-expands-e-commerce-data-pilot-to-ocean-international-mail>

- Global Express Association (GEA). (2019, November). *Overview of de minimis value regimes open to express shipments world wide*. Geneva: GEA. Retrieved from <https://global-express.org/assets/files/Customs%20Committee/de-minimis/GEA%20De%20Minimis%20Country%20information%20as%20of%2018%20November%202019.pdf>
- Goldman Sachs. (2020, June). *Measuring the Reopening of America*. The Goldman Sachs Group, Inc. Retrieved from <https://www.goldmansachs.com/insights/pages/gs-research/measuring-reopening-america-03-jun-20/report.pdf>
- Hagiu, A., & Wright, J. (2015). Marketplace or reseller? *Management Science*, 61(1), 184–203.
- Hintsala, J., Mohanty, S., Tsikolenko, V., Ivens, B., Leischnig, A., Kähäri, P., Hameri, A.-P., & Cadot, O. (2014). *The import VAT and duty de-minimis in the European Union – Where should they be and what will be the impact?* Lausanne: Cross-border Research Association. 10.13140/RG.2.1.3840.8725.
- Holloway, S., & Rae, J. (2011). De minimis thresholds in APEC. *World Customs Journal*, 6(1), 31–61.
- Horwitz, S. (2019, 23 August). *The flow of fentanyl: In the mail, over the border*. Retrieved from Washington Post. <https://www.washingtonpost.com/investigations/2019/08/23/fentanyl-flowed-through-us-postal-service-vehicles-crossing-southern-border/?arc404=true>
- Khan, L. (2017). Amazon's Antitrust Paradox. *Yale Law Journal*, 126, 710–805.
- Khan, L. (2018). Sources of Tech Platform Power. *Georgetown Law Technology Review*, 2, 325–334.
- KPMG International. (2017). *The Truth About Online Consumers: 2017 Global Online Consumer Report*. Zurich: KPMG International. Retrieved from <https://assets.kpmg/content/dam/kpmg/xx/pdf/2017/01/the-truth-about-online-consumers.pdf>
- López González, J., & Jouanjean, M. A. (2017). Digital Trade: Developing a Framework for Analysis. *OECD Trade Policy Papers* (Number 205).
- Mclinden, G., Fanta, E., Widdowson, D., & Doyle, T. (2010). *Border Management Modernization*. Washington, D.C.: World Bank Group. Retrieved from <http://documents.worldbank.org/curated/en/986291468192549495/Border-management-modernization>.
- Organization for Economic Cooperation and Development (OECD)/European Union Intellectual Property Office (EUIPO). (2018). *Misuse of Small Parcels for Trade in Counterfeit Goods: Facts and Trends, Illicit Trade*. Paris: OECD Publishing. <https://doi.org/10.1787/9789264307858-en>
- Organization for Economic Cooperation and Development (OECD). (2002). *OECD Glossary of Statistical Terms*. Paris: OECD. Retrieved from <https://stats.oecd.org/glossary/detail.asp?ID=4721>
- Organization for Economic Cooperation and Development (OECD). (2015). *Addressing the tax challenges of the digital economy*. Paris: OECD. Retrieved from [https://www.oecd-ilibrary.org/taxation/addressing-the-tax-challenges-of-the-digital-economy-action-1-2015-final-report\\_9789264241046-en](https://www.oecd-ilibrary.org/taxation/addressing-the-tax-challenges-of-the-digital-economy-action-1-2015-final-report_9789264241046-en)
- Organization for Economic Cooperation and Development (OECD). (2019). *The Role of Digital Platforms in the Collection of VAT/GST on Online Sales*. Paris: OECD. Retrieved from <http://www.oecd.org/tax/consumption/the-role-of-digital-platforms-in-the-collection-of-vat-gst-on-online-sales.pdf>
- Organization for Economic Cooperation and Development (OECD). (2019). *Trade in the Digital Era*. Paris: OECD. Retrieved from <https://www.oecd.org/going-digital/trade-in-the-digital-era.pdf>
- Organization for Economic Cooperation and Development (OECD). (2019). *Unpacking E-commerce: Business Models, Trends and Policies*. Paris: OECD Publishing. Retrieved from [https://read.oecd-ilibrary.org/science-and-technology/unpacking-e-commerce\\_23561431-en#page1](https://read.oecd-ilibrary.org/science-and-technology/unpacking-e-commerce_23561431-en#page1)
- Organization for Security and Co-operation in Europe (OSCE). (2012). *Handbook of Best Practices at Border Crossings – A Trade and Transport Facilitation Perspective*. OSCE.

- Papis-Almansa, M. (2019). VAT and electronic commerce: the new rules as a means for simplification, combatting fraud and creating a more level playing field? *ERA Forum*, 20, 201–223.
- Pitney Bowes. (2019). *Pitney Bowes Parcel Shipping Index 2019*. Stamford: Pitney Bowes. Retrieved from <https://www.pitneybowes.com/content/dam/pitneybowes/us/en/shipping-index/pitney-bowes-parcel-shipping-index-infographic-2019.pdf>
- Pomerantz, K., & Topik, S. (2018). *The World that Trade Created: Society, Culture, and the World Economy, 1400-the Present* (4th ed.). Routledge.
- Presidential Executive Order. (2020. 31 January). *Ensuring Safe & Lawful E-Commerce for US Consumers, Businesses, Government Supply Chains, and Intellectual Property Rights*. Washington, DC: White House. Retrieved from <https://www.whitehouse.gov/presidential-actions/ensuring-safe-lawful-e-commerce-us-consumers-businesses-government-supply-chains-intellectual-property-rights/>
- Rochet, J. C., & Tirole, J. (2003). Platform Competition in Two-Sided Markets. *Journal of the European Economic Association*, 1(4), 990–1029.
- Satherley, J. (2019. 2 December ). *How new GST rules will increase your online shopping bill*. Retrieved from Westpac Rednews: <https://www.westpac.co.nz/rednews/business/how-new-gst-rules-could-affect-your-online-shopping-bill/>
- Stoller, M. (2019). *Goliath: The 100-Year War Between Monopoly Power and Democracy*. Simon & Schuster.
- United Nations Conference on Trade and Development (UNCTAD). (2016). *In Search of Cross-border E-commerce Trade Data*. Geneva: UNCTAD. Retrieved from [https://unctad.org/en/PublicationsLibrary/tn\\_unctad\\_ict4d06\\_en.pdf](https://unctad.org/en/PublicationsLibrary/tn_unctad_ict4d06_en.pdf)
- United Nations Conference on Trade and Development (UNCTAD). (2020a). *UNCTAD B2C E-Commerce Index 2019*. ICT Policy Section, Geneva: UNCTAD. Retrieved from [https://unctad.org/en/PublicationsLibrary/tn\\_unctad\\_ict4d14\\_en.pdf](https://unctad.org/en/PublicationsLibrary/tn_unctad_ict4d14_en.pdf)
- United Nations Conference on Trade and Development (UNCTAD). (2020b). *UNCTAD E-Commerce & Law Reform Programme*. Geneva: UNCTAD. Retrieved from [https://unctad.org/en/Pages/DTL/STI\\_and ICTs/ICT4D-Legislation.aspx](https://unctad.org/en/Pages/DTL/STI_and ICTs/ICT4D-Legislation.aspx)
- United Nations Economic Commission for Europe (UNECE). (2012). *Trade Facilitation Implementation Guide: The Buy-Ship-Pay Reference Models*. Retrieved from UNECE. <http://tfig.unece.org/contents/buy-ship-pay-model.htm>
- Universal Postal Union (UPU). (2020). *Acts of the Union and other decisions*. Berne: UPU. Retrieved from <https://www.upu.int/en/Universal-Postal-Union/About-UPU/Acts>
- Universal Postal Union (UPU) & World Customs Organization (WCO). (2019). *WCO–UPU guidelines on the exchange of electronic advance data* Brussels: WCO. Retrieved from WCO. <http://www.wcoomd.org/-/media/wco/public/global/pdf/topics/facilitation/instruments-and-tools/tools/upu/joint-wco-upu-guidelines.pdf?la=en>
- Urciuoli, L., & Hintsä, J. (2018). Improving supply chain risk management – can additional data help? *International Journal of Logistics Systems and Management*, 30(2), 195–223.
- US Customs and Border Protection (US CBP). (2018). *CBP E-commerce Strategic Plan*. Washington, D.C.: US CBP. Retrieved from <https://www.cbp.gov/document/publications/cbp-e-commerce-strategic-plan>
- US Customs and Border Protection (US CBP). (2019). *Section 321 Programs*. Washington, D.C.: US CBP. Retrieved from <https://www.cbp.gov/trade/trade-enforcement/tftfea/section-321-programs>

- US Customs and Border Protection (US CBP). (2020, January). *CBP and Trade Partners are Taking Action to Secure eCommerce Supply Chains*. Washington, D.C.: US CBP Newsroom. Retrieved from <https://www.cbp.gov/newsroom/national-media-release/cbp-and-trade-partners-are-taking-action-secure-ecommerce-supply>
- US Customs and Border Protection (US CBP). (2020). *CBP E-Commerce Strategy*. Washington, D.C.: US CBP. Retrieved from <https://www.cbp.gov/trade/basic-import-export/e-commerce>
- Widdowson, D. (2007). The Changing Role of Customs: Evolution or Revolution. *World Customs Journal*, 1(1), 31–37.
- World Customs Organization (WCO). (2005). *SAFE Framework of Standards to Secure and Facilitate Global Trade*. Brussels: WCO. Retrieved from <http://www.wcoomd.org/-/media/wco/public/global/pdf/topics/facilitation/instruments-and-tools/tools/safe-package/safe-framework-of-standards.PDF?la=en>
- World Customs Organization (WCO). (2006). *International Convention on the Simplification and Harmonization of Customs Procedures*. Brussels: WCO. Retrieved from [http://www.wcoomd.org/en/Topics/Facilitation/Instrument%20and%20Tools/Conventions/pf\\_revised\\_kyoto\\_conv/Kyoto\\_New](http://www.wcoomd.org/en/Topics/Facilitation/Instrument%20and%20Tools/Conventions/pf_revised_kyoto_conv/Kyoto_New)
- World Customs Organization (WCO). (2008). *Customs in the 21st Century*. Brussels: WCO. Retrieved from [http://www.wcoomd.org/~/-/media/wco/public/global/pdf/topics/key-issues/customs-in-the-21st-century/annexes/annex\\_ii\\_en.pdf?la=en](http://www.wcoomd.org/~/-/media/wco/public/global/pdf/topics/key-issues/customs-in-the-21st-century/annexes/annex_ii_en.pdf?la=en)
- World Customs Organization (WCO). (2017a). *Resolution on Principles for Cross-Border E-Commerce*. Brussels: WCO. Retrieved from [http://www.wcoomd.org/-/media/wco/public/global/pdf/about-us/legal-instruments/resolutions/policy-commission-resolution-on-cross\\_border-ecommerce\\_en.pdf?la=en](http://www.wcoomd.org/-/media/wco/public/global/pdf/about-us/legal-instruments/resolutions/policy-commission-resolution-on-cross_border-ecommerce_en.pdf?la=en)
- World Customs Organization (WCO). (2017b). *WCO Study Report on Cross-Border E-Commerce*. Brussels: WCO. Retrieved December 12, 2019, from <http://www.wcoomd.org/-/media/wco/public/global/pdf/topics/facilitation/activities-and-programmes/ecommerce/wco-study-report-on-e-commerce.pdf?la=en>
- World Customs Organization (WCO). (2018a). *Cross-Border E-Commerce Framework of Standards*. Brussels: WCO. Retrieved January 15 2020, from [http://www.wcoomd.org/-/media/wco/public/global/pdf/topics/facilitation/activities-and-programmes/ecommerce/wco-framework-of-standards-on-crossborder-ecommerce\\_en.pdf?db=web](http://www.wcoomd.org/-/media/wco/public/global/pdf/topics/facilitation/activities-and-programmes/ecommerce/wco-framework-of-standards-on-crossborder-ecommerce_en.pdf?db=web)
- World Customs Organization (WCO). (2018b). *WCO Immediate Release Guidelines*. Brussels: WCO. Retrieved 2020, from <http://www.wcoomd.org/-/media/wco/public/global/pdf/topics/facilitation/instruments-and-tools/tools/immediate-release-guidelines/immediate-release-guidelines.pdf?db=web>
- World Customs Organization (WCO). (2019, August). *E-Commerce Package*. Brussels: WCO. Retrieved January 10, 2020, from <http://www.wcoomd.org/en/topics/facilitation/instrument-and-tools/frameworks-of-standards/ecommerce.aspx>
- World Customs Organization (WCO). (2019). *Technical Specifications (Framework of Standards on Cross-Border E-Commerce)*. Brussels: WCO. Retrieved from [http://www.wcoomd.org/-/media/wco/public/global/pdf/topics/facilitation/activities-and-programmes/ecommerce/1\\_technical-specifications\\_en.pdf?db=web](http://www.wcoomd.org/-/media/wco/public/global/pdf/topics/facilitation/activities-and-programmes/ecommerce/1_technical-specifications_en.pdf?db=web)
- World Customs Organization (WCO). (2020a). *Cross-Border e-Commerce Topic Webpage*. Brussels: WCO. Retrieved from <http://www.wcoomd.org/en/topics/facilitation/activities-and-programmes/ecommerce.aspx>
- World Customs Organization (WCO). (2020b). *The Working Group on E-Commerce meets to finalise outstanding work items*. Brussels: WCO Newsroom. Retrieved from <http://www.wcoomd.org/en/media/newsroom/2020/february/the-working-group-on-e-commerce-meets-to-finalise-outstanding-work-items.aspx>

- World Customs Organization (WCO). (2020c). *WCO in Brief: WCO Mission Statement*. Brussels: WCO. Retrieved from [http://www.wcoomd.org/en/about-us/what-is-the-wco/mission\\_statement.aspx](http://www.wcoomd.org/en/about-us/what-is-the-wco/mission_statement.aspx)
- World Customs Organization (WCO). (2020d). *WCO SAFE Package*. Brussels: WCO. Retrieved from [http://www.wcoomd.org/en/topics/facilitation/instrument-and-tools/frameworks-of-standards/safe\\_package.aspx](http://www.wcoomd.org/en/topics/facilitation/instrument-and-tools/frameworks-of-standards/safe_package.aspx)
- World Trade Organization (WTO). (2017). *Agreement on Trade Facilitation*. Geneva: WTO. Retrieved from [https://www.wto.org/english/docs\\_e/legal\\_e/tfa-nov14\\_e.htm](https://www.wto.org/english/docs_e/legal_e/tfa-nov14_e.htm)
- World Trade Organization (WTO). (2020). *WTO Electronic Commerce Gateway*. Geneva: WTO. Retrieved January 12, 2020, from [https://www.wto.org/english/tratop\\_e/ecom\\_e/ecom\\_e.htm](https://www.wto.org/english/tratop_e/ecom_e/ecom_e.htm)
- World Trade Organization (WTO) Member Delegations. (2019. 25 January). *Joint Statement on Electronic Commerce*. Geneva: WTO. Retrieved from EU Commission [https://trade.ec.europa.eu/doclib/docs/2019/january/tradoc\\_157643.pdf](https://trade.ec.europa.eu/doclib/docs/2019/january/tradoc_157643.pdf)
- World Trade Organization (WTO) Secretariat. (2010). *Background Note on Postal and Courier Services*. Geneva: WTO. Retrieved from <https://docs.wto.org/dol2fe/Pages/SS/directdoc.aspx?filename=Q:/S/C/W319.pdf&Open=True>
- World Trade Organization (WTO) Secretariat. (2020). *E-Commerce, Trade and the COVID-19 Pandemic*. Geneva: WTO. Retrieved from [https://www.wto.org/english/tratop\\_e/covid19\\_e/ecommerce\\_report\\_e.pdf](https://www.wto.org/english/tratop_e/covid19_e/ecommerce_report_e.pdf)
- Yu, T. (2018). A case study of B2C cross-border e-commerce challenges in China from Customs to consumers. *World Customs Journal*, 12(2), 121–132.

## Notes

- 1 It should be noted that in some contexts direct sales arrangements between individuals are separated out into a sub-category of ‘C2C’, or ‘consumer-to-consumer’ transactions; to the extent such transactions are essentially commercial in nature, they are incorporated in the broader category of B2C for purposes of this paper.
- 2 From the perspective of border clearance, these provisions are closely linked to the concept of ‘declarant’ under Chapter 3 of the RKC General Annex.
- 3 In parallel to the WGEC discussions, the WCO and the UPU conducted joint efforts focused on upgrading data-sharing on postal consignments for border clearance purposes; these efforts culminated in the Guidelines on the Exchange of Electronic Advance Data (UPU & WCO, 2019).

### Bryce Blegen



Bryce Blegen is CEO of Trusted Trade Alliance LLC, headquartered in Vancouver, Washington, USA and is a member of the board of the International Customs Law Academy. He is the Regional Representative, Americas, and a Senior Lecturer for the Centre for Customs & Excise Studies, Charles Sturt University. Mr. Blegen’s research is focused in the areas of US Customs & trade law, border management policy, supply-chain security and AEO programs, export controls and sanctions, and the application of technology in cross-border processes. He is currently a PhD candidate at Charles Sturt University.



# The WCO's impact to date and lessons learned: the road from Columbus to Competency

*David Hesketh*

## Abstract

---

Customs was one of the six areas highlighted for improvement by the United Nations International Symposium on Trade Efficiency, which was held in Columbus, Ohio, in 1994. A review by the World Customs Organization (WCO) of their training for members led to the start of a Customs Reform and Modernisation program in 1994. In 2005 an informal strategy set the scene for (a) the development of professional standards, (b) the International Network of Customs Universities and (c) the *World Customs Journal*. In 2008 the WCO published the first Partnerships in Customs Academic Research and Development (PICARD) standards and in 2017 the European Commission published the European Union (EU) Customs Competency Framework for operational and management development in the customs profession. The road from the Columbus Declaration in 1994 has been long and difficult. The perseverance of many has addressed the need for managerial skills, knowledge and capacity to a point where the customs profession is better now than 25 years ago.

---

## 1. Columbus: trade and customs

The United Nations International Symposium on Trade Efficiency, held in Columbus, Ohio, from 17 to 21 October 1994 and chaired by the Secretary of Commerce of the United States of America, was an unprecedented event that brought together the private sector and national and local governments in an important forum for proposing practical solutions to some of the problems encountered in international trade. The symposium adopted the Columbus Ministerial Declaration, which potentially set the scene for a worldwide process to enhance participation in international trade (United Nations, 1994a).

During this symposium the United Nations made a significant observation that 10 per cent of the cost of world trade was due to border control transaction costs, such as Customs, quality standards (including sanitary and phytosanitary requirements), and port and airport management (United Nations, 1994b).

Supporting statistics include:

- world trade in 1994 was \$4,000 billion
- tariffs amounted to \$200 billion
- non-tariff measures cost \$800 billion
- transaction costs amounted to \$400 billion
- trade Efficiency potential gains, by the year 2000, were \$100 billion.

These hard-hitting statistics were widely quoted for many years—notably, and not least, by the United Nations Conference on Trade and Development (UNCTAD) Special Programme on Trade Efficiency—and often formed the justification for subsequent border-related reform and modernisation programs.

The assertion was that there was room for 25 per cent efficiency savings in trade transaction costs, which equated to \$100 billion. However, a United Nations Economic Council for Europe (UNECE) Working Party on the Facilitation of International Trade Procedures in 1996 (UNECE, 1996) went on to question the validity of this data, quoting research by the International Express Couriers Conference that represented companies such as FedEx and DHL. Nevertheless, the ‘10 per cent of world trade’ quotation was used by many, including the WCO, as a seemingly credible justification to launch a range of initiatives aimed at increasing the efficiency of trade-related procedures, including the reform and modernisation of customs administrations.

Based on a range of problems in international trade described by the United Nations, such as lack of automation, high transport costs, inefficient banking, and corruption, the symposium went on to set practical actions, recommendations and guidelines for governments and international and national organisations and enterprises. These recommendations and guidelines addressed six areas that they believed were likely to generate tangible results for international trade within something they then called the ‘door-to-door logistics chain’. These areas were:

- customs
- transport
- banking and insurance
- information for trade
- business practices
- telecommunications.

Areas of particular importance in which energies were to be combined included the adoption, promotion and implementation of international standards, as well as technical and legal frameworks facilitating trade-efficient measures. They agreed that technical assistance programs were needed in the areas of:

- training and awareness in the main areas of trade facilitation and trade efficiency
- integration of trade-efficient measures in Customs and in the financial, transportation and telecommunications sectors
- promotion and use of agreed international norms and standards for collecting and transmitting trade-related information and messages.

This introduction is significant for two main reasons. The first is that in 1994 the WCO had been developing its Customs Reform and Modernisation program for two or three years and the increased emphasis on customs reform, supported by quotable data from the International Symposium on Trade Efficiency (the Columbus Declaration) gave this initiative considerable international credence. The second reason is that the recognition of these six areas formed a significant focus of attention when, having been neglected by UNCTAD for many years, the recognition of the ‘door-to-door logistics chain’ resurfaced in an initiative in 2005 but called the ‘international trade supply chain’.

When linked with the growing initiative in the WCO to improve customs administrations, the symposium in 1994 was a significant milestone in the recognition that something had to be done to increase the efficiency of importing and exporting cargo around the world. Globalisation and electronic business were just being recognised and the growing demands for change were creating powerful drivers for Customs to reform and modernise.

## 2. WCO: customs reform

In about 1991, prior to but not connected to the significant trade symposium in Columbus, Ohio, the WCO started to carry out research into its program of external training for members. This had been made up of a number of good-quality, well-recognised and respected modules, delivered mainly in developing countries but also, at times, regionally. Within the WCO Secretariat a small training team, later known as Human Resource Development Services and then Capacity Building, undertook an evaluation of the WCO technical training, using Donald L Kirkpatrick's training evaluation model (Kirkpatrick, 1975, 1998). The four levels of Kirkpatrick's evaluation model essentially measure the:

- reaction of the student – what they thought and felt about the training
- learning – the resulting increase in knowledge or capability
- behaviour – extent of behaviour and capability improvement and implementation/application
- results – the effects on the business or environment resulting from the trainee's and organisational performance.

Level 4 evaluation looked at the effect on the business or environment of the overall training program. The findings indicated that:

- the training was good, well delivered and well received
- there were no individual or organisational needs assessments carried out, so training needs were not identified
- normal management systems in Customs were often not in place to measure individual, team or organisational targets or performance
- there was often no effective management structure or management skills in place
- often the wrong student was sent on the training
- the reason for sending someone on training was often as a reward, rather than developmental, particularly if the training was overseas
- having received the training, often students were then identified as having promotion potential, so they were moved or promoted away from the job
- customs administrations generally lacked any business strategy or plans, lacked strategic and operational management and lacked simple management systems such as planning, budgeting, reporting, performance measurement or strategic support services such as human resource management, IT or communications
- inefficiency and corruption in some customs administrations was a recognised way of life by government, Customs and by international traders and stakeholders.

The problem seemed to be that customs administrations, over the years, had been seen to be something quite mystical, powerful and authoritarian by government, by the trade and even by Customs themselves. Customs had the power of the law behind them and, without any formalised accountability or independent appeals procedures, could wield that authority pretty much how they wanted. In developing countries, long delays of weeks rather than hours or days to import and export cargo were commonplace; poor working conditions and very low pay linked with unaccountable misuse of power meant that corruption and inefficiency were commonplace (and generally accepted by the trade) and ineffective human resource policies resulted in poor recruitment and skills at all levels. As explained by James T Walsh, former Deputy Division Chief in the International Monetary Fund's (IMF) Fiscal Affairs Department:

It has become fashionable to refer to the work of a Customs Administration, and its improvement, as an aspect of ‘trade facilitation’. But this is Orwellian newspeak, given that Customs administration inescapably impedes trade. The point of modernisation is to reduce the impediments (IMF, 2006).

From 1991 to 1993 the WCO realised the extent and impact that inefficient customs administrations were having on national revenue and world trade and in 1994 the International Symposium on Trade Efficiency also painted a gloomy picture, which supported the WCO’s findings.

### 3. WCO diagnostic study

The WCO appreciated the significance of their own training review and, perhaps for the first time, found itself recognising major problems within the member administrations that were not of a technical nature. They understood the strategic importance of these issues and considered how to address the subject of organisational deficiencies. The WCO commenced work to build a self-help diagnostic tool. The aim was to assist managers in customs administrations to analyse the environment within which they were operating, diagnose problems, formulate solutions and draft a development plan to put things right. By involving senior managers in the process, it was anticipated that it would build not only diagnostic skills but enhance management practice, revenue income, enforcement, trade efficiency and service orientation. This was the Customs Reform and Modernisation (CRM) program (WCO, 1995a).

Within this CRM program, the WCO saw their role to:

- equip beneficiaries with the tools necessary to make a self-assessment of their requirements and set a reform and modernisation plan
- be a reliable source of information on customs matters, as well as an accessible bank for a portfolio of training and organisational development aids such as easily adaptable training modules and good practices guides
- act as an honest broker of donor expertise and beneficiary needs.

The WCO, Canada and the Netherlands, with some assistance from other members such as the United Kingdom, drafted a comprehensive Diagnostic Study User Guide as the main vehicle of the CRM program. It was finalised in November 1995 (WCO, 1995b). Box 1 describes the overall process.

<b>Box 1: The diagnostic study process</b>	
<p><b>Introduction</b> Background Objectives Benefits Considerations before you begin How to use this Guide</p> <p><b>Process</b></p> <p><b>1. Analysis phase</b> The role of Customs Developments in Customs, a future perspective</p> <p><b><i>The Customs environment</i></b> The external environment analysis The internal environment analysis Conclusion Problem statements</p> <p><b><i>Analysis process tools</i></b> Worksheets 1 to 8</p> <p><b>2. Diagnosis and decision phase</b> Introduction</p> <p><b><i>Defining the problems</i></b> <b><i>Finding the root causes of the problem</i></b> <b><i>Searching for solutions</i></b> Generating all possible solutions Evaluating solutions</p> <p><b><i>Making decisions</i></b> <b><i>Setting strategic priorities</i></b> Worksheets 9 to 13</p>	<p><b>3. Planning and implementation phase</b> Introduction</p> <p><b><i>Drawing up a plan</i></b> Setting goals Activity planning Determining resource requirements Determining time requirements Scheduling</p> <p><b><i>Assessing your own strengths and constraints</i></b> Review of analysis data Needs analysis External assistance External assistance plan</p> <p><b><i>Implementation plan – Communication strategy</i></b> Worksheets 14 to 22</p> <p><b>4. Follow-up phase</b> <b><i>Purpose of the follow-up</i></b> <b><i>Characteristics of the follow-up</i></b></p>

It became clear early on in experimenting with this process that the customs administrations in countries that were in most need of improvement struggled to come to terms with this ‘management’ approach, even when it was explained carefully and deliberatively. The lack of strategic and operational management skills had been significantly responsible for the poor performance of the customs administrations that would be benefiting from the CRM program. To expect them to embrace this relatively sophisticated approach to organisational improvement proved to be too ambitious.

Moreover, the expectation that the customs administration would also have the wherewithal to contextualise the findings of the diagnostic study and manage the improvement process, ostensibly with limited assistance from outside, also proved unrealistic. And if these two lessons were not damaging enough for the initial policies of the WCO, it also became clear that the content of the Diagnostic Study User Guide was so detailed and complicated that it was impossible to work through the entire process in the two-week workshop and it was unrealistic to leave it with the beneficiary administration to learn how to use it themselves.

By 1996 it was clear that the Diagnostic Study User Guide, while being a highly valuable document and the product of considerable work by many in the WCO team, was over engineered and too detailed.

What was needed by the beneficiary administrations was more high-level concepts and analysis and far more support in both the diagnosis and implementation than had, at first, been anticipated. In many respects the key to achieving the required improvements was to identify the ‘drivers for change’ and the stakeholders involved in the strategic problems and mobilise their support and commitment for the solutions. The technical detail would come later. This was genuinely a breakthrough in the international arena by moving away from a ‘shopping list’-based approach to aid and assistance, with little value-for-money assessment, to a more realistic program for change based on analysis, ownership, partnership and commitment. Management skills development as part of this process was essential.

From 1998 onwards, various policies were developed in the WCO leading up to the aptly named Columbus Programme, aimed at building capacity in the countries that had signed up to the SAFE Framework of Standards.

### 4. A new strategy

In 2005, a meeting was held at the WCO in Brussels between a small number of participants from member customs administrations, the private sector, universities, and the WCO Capacity Building Team. An informal strategy was agreed to help address the emerging need for better research and management development within the customs profession. The proposal was for a three-pronged approach.

- Professional standards, published by the WCO, would properly describe and develop senior and middle management competencies in the customs profession.
- University courses would deliver bachelor and master programs in support of the professional standards and to enhance management capabilities in the customs profession.
- Research would be carried out on a wide range of topics by academics, students and customs practitioners in order to assist with the current and future issues facing the customs profession. That research would be published in the *World Customs Journal*.

Professor David Widdowson AM has been a critical player in achieving and delivering that informal but invaluable strategy.

### 5. Technical and management competence

Two of the fundamental issues concerning capacity building and institutional and organisational development in customs administrations are those of technical and management competence. Poor strategic management is often the cause of organisational failure, yet it is strategic management that holds the key to change and improvement. When faced with the issues caused by poor senior management it’s often the senior managers themselves who deny there’s a problem. A conundrum.

In 2008 the WCO, together with the International Network of Customs Universities, adopted the WCO PICARD program, which set common standards for strategic and operational customs managers aimed at the professionalisation of Customs (see Widdowson, 2015).

These professional standards were developed with three main purposes:

- The development of benchmarks that can be developed into job profiles for customs recruitment
- The development of benchmarks against which in-house training can be measured
- The development of standards against which academic development can be designed or procured.

The standards can and are being used by the academic world to develop educational programs that provide professional qualifications for customs staff to BA and MBA levels.

In 2011 the European Parliament's Internal Market and Consumer Protection Commission's review of customs modernisation concluded that the skills, knowledge and experience of customs professionals should be in constant development and improvement, as these are prerequisites for high-quality customs procedures. The report identified the need to provide customs officers and economic operators with adequate training in order to ensure the uniform enforcement of EU rules and better protection for consumers (European Commission, 2011, paras 68–69). These principles apply to Customs worldwide.

Later, in 2011, the European Commission carried out a feasibility study to consider an academic program for the customs profession within the EU (EU, 2011). Research within the EU had shown a lack of harmonisation in the understanding and application of EU customs regulations and systems, along with limited strategic, management and advanced technical competencies (Expert project steering group, 2011).

Different national interpretations of the EU customs legislation created red tape for business, with a consequential negative impact on European competitiveness, and this weakened the EU's ability to administer an efficient risk-based approach to compliance (European Commission, 2011, para 39).

As a result of these gaps, companies often struggled to strategically and effectively manage their customs obligations and integrate customs management within their operations (Expert project steering group, 2011).

Customs administrations of member states found themselves lacking capacity in critical areas and suffered a diminution of their capacity to develop effective new approaches.

The customs profession as a whole faced challenges around change capacity and innovation as a result of these gaps. The introduction of the European Union Customs Code in 2013 brought these issues to the fore. The research also showed an overreliance on traditional experientially led internal training provision.

Changes that have occurred and continue to occur, in particular through the introduction of modern legislation, have significantly altered the nature of 'customs' and the cross-border movements of goods. Consequently, the needs of those working in the field have changed. As an example, the introduction of the authorised economic operator (AEO) within the Union Customs Code requires practical standards of competence or professional qualifications directly related to the activity carried out. Accreditation of AEO demands in-depth knowledge of the (global) supply chain and auditing within customs agencies and requires greater knowledge of the breadth of customs procedures within the trade organisation. Awkwardly, these criteria only apply to commercial economic operators and not to the Customs Administrations, potentially leading to a skills gap.

Both the European Commission and the global community of customs administrations have concluded that strategic and managerial development are of critical importance to the future of customs. The EU Feasibility Study Expert Group concluded that there is a pressing need for action to optimise the training and development system within the customs profession and lift it to a higher level. The envisaged parts of the training and development structure were:

Part 1 – Shared training and development: a mixed provision of training and development materials and a shared learning infrastructure to support technical and advanced technical training provision throughout the EU.

Part 2 – Education for the customs profession: core curricula and accredited training programs (delivered by appropriate educational institutions, customs academies, trade organisations etc.) at BA and MA levels. This provision should be built on agreed EU core curricula and standards for BA/MA content that would be developed out of the competency framework.

Part 3 – Strategic development: advanced strategic and managerial training for leaders within the customs profession at MBA/PhD or equivalent level. Targeting the current and future senior leaders, this provision would be a mixture of core content specific to the customs profession, managerial development delivered internally or by specialist providers, and staff attendance at MBA or equivalent courses.

Underpinning this structure is a competency framework, developed by the European Commission and adopted by the WCO. This establishes a common view of professional competencies and provides the base from which new materials will be developed, gaps and requirements are identified, and current materials and provision tested. This is critical to enabling coordination and harmonisation of the competencies and standards across the customs profession.

The EU Customs Competency Framework (European Union, 2017, p. 2) aims to make optimal use of staff competencies to increase the performance of an entire organisation. It contains a set of four categories of competencies at different proficiency levels (aware, trained, advanced and expert):

- customs core values
- professional competencies
- operational competencies
- management competencies.

The ‘customs profession’ is a term that is defined very broadly to reflect the full scope of work for customs and trade professionals who are involved in any stage of the external border crossing supply chain—be they in the public or private sectors, in roles specifically defined as customs-related or merely responsible for certain tasks related to goods crossing borders.

## 6. Conclusion

Through the PICARD standards the WCO has recognised that the development of strategic and managerial skills, knowledge and capacity are key to the future success of customs. The standards, ratified by the WCO Council in 2009 fundamentally assert two things:

1. That customs, and the environment within which it operates, has fundamentally changed and continues to evolve rapidly. The introduction to the PICARD standards states: *‘The role of Customs in the 21st century, as it faces the challenges posed by globalization, trade facilitation initiatives, and security concerns necessitates a renewed professional approach to the management and operations of Customs administrations across the globe’* (WCO, 2019).
2. First and foremost, it is strategic and managerial leaders and their skills and knowledge that will determine how successfully customs organisations are able to respond to these changes.

The standards do not seek to identify the skills and knowledge required at operational levels but ‘to create a set of common, internationally recognized standards for the professional development of Customs managers’.

They focus specifically on two levels: strategic managers/leaders (senior management) and operational managers/leaders (middle management). They do so because these personnel must be able to evolve new strategies to respond to the changing environment, to guide their organisations in adopting new structures and approaches and to develop new operational delivery mechanisms which are suited to the new role of Customs.



In developing and ratifying these standards, and placing such importance on them, the WCO gives the clear message that the majority of customs agencies globally believe strategic and managerial development to be critical. This is persuasive evidence in support of the idea that strategic and managerial development is critical to the customs profession (Expert project steering group, 2011, p. 3, conclusion 1.)

The WCO Model Code of Ethics and Conduct (WCO, n.d., p. 1) says that Customs employees have a responsibility to their government and its citizens to place loyalty to the government, laws and ethical principles above private gain. The public is entitled to have complete confidence, trust and respect in the integrity of its customs administration and to expect all customs employees to be honest, impartial and professional in the manner in which they employ their skills, knowledge, experience and official authorities.

All customs employees must accept and perform duties with honesty, care, diligence, professionalism, impartiality and integrity.

The road from the Columbus Declaration in 1994 for a worldwide process to enhance participation in international trade has been long, winding and full of bumps. However, the perseverance of many in the WCO and the International Network of Customs Universities has ensured the strategic development of academic and research programs that have addressed the need for managerial knowledge and skills.

We, in the customs profession, are in a better place now than we were 25 years ago. This has been due, in no small measure, to academic research and the *World Customs Journal*, academic development through universities delivering world-class bachelor and master programs, modern legislation and the recognition of the role of institutional and organisational development in improving strategic and managerial skills, knowledge and capacity.

## References

- European Commission (EC). (2011). *Report on modernisation of customs by the Committee on the Internal Market and Consumer Protection*. (2011/2083(INI)). <https://www.europarl.europa.eu/sides/getDoc.do?pubRef=-//EP//NONGML+REPORT+A7-2011-0406+0+DOC+PDF+V0//EN>
- European Union (EU). (2011). *EU Reference training programmes for academic customs education: Master's and Bachelor programmes*. [https://ec.europa.eu/taxation\\_customs/sites/taxation/files/eu\\_reference\\_training\\_programmes\\_for\\_academic\\_customs\\_education\\_new\\_en.pdf](https://ec.europa.eu/taxation_customs/sites/taxation/files/eu_reference_training_programmes_for_academic_customs_education_new_en.pdf)
- European Union (EU). (2017). *EU customs competency framework*. EU Publications. <https://op.europa.eu/en/publication-detail/-/publication/1a46d30f-de14-11e6-ad7c-01aa75ed71a1/language-en>
- Expert project steering group. (2011, December). *Study of an EU academic programme for Customs*. Final Recommendations and Report to the EU Customs Policy Group.
- International Monetary Fund (IMF). (2006). *Finance and development*. March 43(1). <https://www.imf.org/external/pubs/ft/fandd/2006/03/index.htm>
- Kirkpatrick, D. L. (1975). *Evaluating training programs*. Berrett-Koehler.
- Kirkpatrick, D. L. (1998). *Evaluating training programs: The four levels*. Berrett-Koehler.
- United Nations (UN). (1994a). *International Symposium on Trade Efficiency: resolution/adopted by the General Assembly*. UN Digital Library. <https://digitallibrary.un.org/record/172081>
- United Nations (UN). (1994b). *International Symposium on Trade Efficiency*. Fact Sheet 5, 17–21 October 1994.
- United Nations Economic Commission for Europe (UNECE). (1996). *UNECE TRADE/WP.4/R.1260*. 17 June 1996.

- Widdowson, D. (2015). 10 years of promoting the academic standing of the customs profession. *World Customs Journal*, 9(2), 111–113.
- World Customs Organization (WCO). (1995a). *Customs Reform and Modernisation Programme*. Policy Document.
- World Customs Organization (WCO). (1995b). *Diagnostic study user guide*. [www.wcoomd.org](http://www.wcoomd.org)
- World Customs Organization (WCO). (n.d.). *Model code of ethics and conduct*. WCO Publications. <http://www.wcoomd.org/-/media/wco/public/global/pdf/topics/integrity/instruments-and-tools/model-code-of-ethics-and-conduct.pdf?la=en>
- World Customs Organization (WCO). (2019). *PICARD Professional Standards*. <http://www.wcoomd.org/-/media/wco/public/global/pdf/topics/capacity-building/activities-and-programmes/picard/professional-standards/omd-normes-prof-uk-basse-def.pdf?la=en>

### David Hesketh



David Hesketh is an educator and innovator in the world of customs and trade. After 42 years' service he retired from UK Customs in May 2017 as Head of Customs Research and Development. He has extensive international customs experience. From 1995 to 1998 David worked partly for the World Customs Organization as a member of the Customs Reform and Modernisation team. From 1998 to 2000 he was the DFID Field Manager, based in the Caribbean, for Customs Modernisation Projects in St Lucia and Grenada. From 2005 to 2008 he worked in the private sector as Revenue Business Development Director with Crown Agents and from 2016 to 2018 for British Maritime Technology as UK Work Package Leader in the EU funded CORE Project. He is a tutor for the Centre for Customs and Excise Studies, Charles Sturt University, researching and delivering online courses on Supply Chain Management, Supply Chain Security, Customs Duty Reliefs and European Customs Legislation. He holds a master's degree in International Customs Law and Administration.

# The World Customs Organization as a knowledge-based organisation

*Jenia Peteva*

## Abstract

---

The world of international organisations may soon be different from the one that we now know. Knowledge management is an appropriate driver of such a transition because it provides a process-based method to support a shift towards a knowledge economy.

This article explores the nature of the World Customs Organization (WCO) as a knowledge-based organisation. It analyses how the WCO has embraced knowledge management by embedding knowledge fostering, knowledge co-creation and knowledge sharing into its processes, programs and activities. This article then argues that the WCO has paved the way to leverage customs knowledge into action and should extend its tools and practices in a transformation from a knowledge-based organisation towards a knowledge organisation.

---

## 1. Introduction

*'A world without international organisations as we know them now is not a pure fiction'*

— Dupont, 2020

This conclusion was made in an article published in February 2020. Within just three weeks the World Health Organisation (WHO) announced the COVID-19 outbreak a pandemic.

The global customs community is looking for new, more agile forms of global cooperation; for redesigned customs procedures and controls; and new, more flexible and agile forms of intergovernmental and global cooperation and collaboration. How can the WCO best adapt to modern challenges among measures of border closures, ever rising trade and transport restrictions, and gloomy economic forecasts?

This article considers the role of knowledge management in the transformation of the WCO in an emerging international governance. It explores the nature of the WCO as a knowledge-based organisation and then traces its transformation into a knowledge organisation.

First, it explores the nature of the WCO as an international organisation. It then reflects on the nature of knowledge and data and their role for the customs community, before considering the role of knowledge sharing for the WCO. Later, it notes the trends and perspectives that deepen this experience and transform the WCO into a knowledge organisation based on a knowledge-driven ability to act. This article argues that the WCO should become a true knowledge organisation with a knowledge strategy and vision, and developed knowledge management practices.

## 2. WCO as an international organisation

### 2.1 Evolution of the WCO

The origins of the WCO date back to 1952 when the Customs Co-operation Council was established. At the time, this was a process-oriented technical body tasked with unifying customs procedures. Sixty-eight years later, the competencies of the organisation have developed in terms of substantive scope and process as well as in terms of project management.

Customs is a major border authority. As such, it is entrusted with significant enforcement powers. The growth of global trade brought with it new challenges for border management. Customs assumed new non-fiscal responsibilities, which affected the scope of its activities and demanded the cooperation with other border agencies and other economic actors.

The mission of the WCO today is based on a vision of a standard setting, decision-making body. It unifies the legal framework for customs activities and streamlines processes and projects that enable customs cooperation. The WCO is the forum of the global customs community and fosters innovation and collaboration among a diverse group of internal and external stakeholders.

### 2.2 Competencies

The proposal for the 2019–2022 strategic plan of the WCO underlines ‘the *continuity* of the WCO’s role as *the only international organisation completely focused on setting international standards* for Customs procedures, fostering Customs-to-Customs cooperation and providing its Members with Customs Capacity Building’ (WCO, 2019a, p. 2). This mission statement underlines the standard-setting function of the organisation. It also traces the WCO intermediary function in connecting and supporting customs administrations.

The scope of the WCO competencies extends beyond process management, unification of customs procedures, and unification of technical customs matters such as tariff, customs origin and customs valuation. There has been a shift in priorities and allocation of resources towards a different fundamental role, namely the role to foster global joint efforts to:

- facilitate legal trade
- secure fair revenue collection
- protect society.

While providing leadership, guidance and support to customs administrations, the WCO uses performance measurements and organisational development strategies that encourage crosscutting issues (WCO, 2019a, p. 3). This strategic approach stimulates stakeholder analysis, extended collaboration and multi-disciplinary views on issues, with a shift towards collaborative scientific research methods. The expansion and linkages of competencies at the WCO encourages the scope of application for process governance and knowledge-based methods to ensure the smooth implementation of business processes.

### 2.3 Process perspective

The cross-cutting layer in the competence of the WCO has been translated into three types of interrelated processes (WCO, 2019, p. 3):

- International standards for: 1) the Economic Competitiveness Package; 2) the Revenue Package; and 3) Compliance and Enforcement Package

- Cooperation for: 1) the Organisational Development Package; 2) Joint Operations and Exchange of Information; and 3) Sharing of knowledge and best practices
- Capacity building for: 1) technical assistance and capacity building for implementation of international standards; and 2) technical assistance and training on people development.

These processes build on an extensive data ecosystem. The creation of a data ecosystem is a consequence of the intensive data needs to ensure the unifying of customs procedures and the data exchanges related to them. It is also an enabler for building databases, compendiums and creating global data models, such as the SAFE Framework of Standards to Secure and Facilitate Global Trade as adopted by the WCO Council (WCO, 2018b). The WCO data ecosystem goes hand in hand with its technology enablers related to the digitalisation of customs and the extended use of data analytics, as well as the growing customs cooperation based on exchange of information.

The impact of the links between customs processes and supply chain, the role of new non-technical issues—such as corporate social responsibility, fair trade, human rights in customs controls and border management—would further increase the links between substantive issues and processes that govern their implementation.

## **2.4 Stakeholders**

The main internal stakeholders of the WCO are its members—the governments of 183 sovereign states. They work together in the institutional bodies of the WCO, or in the framework of customs cooperation or capacity building.

The evolution of the WCO has witnessed strong cooperation with external stakeholders, in particular:

- other international organisations
- representatives of industry
- the academic community.

External stakeholders are involved in consultancy activities as part of the standard-setting groups. In addition, there is a growing trend for mixed partnerships between academia and practitioners. The Partnership in Customs Academic Research and Development (PICARD) movement and its research networks also form part of this development.

## **2.5 Global governance organisation**

Throughout its 68-year history, the WCO has seen a widening and deepening of its competence as well as an increase in the number of stakeholders. Now it is ‘a global centre of Customs excellence’ (WCO, 2019a, p. 6). It is truly an innovation and standard-setting hub for the customs community around the world.

The role of the WCO has grown from one of a traditional international organisation, with hierarchical and centralised decision-making at its core, towards a centre that generates, operates and creates linkages among diverse networks of varied stakeholders.

The WCO is a pioneer and leader in strategic global dialogue on initiatives that shape the customs agenda, in particular on the issues of e-commerce, data analysis and digital customs, capacity-building strategy and integrated border management. Moreover, these issues are among the strategic priorities and emerging initiatives for the period until 2022 (WCO, 2019a, p. 14).

Furthermore, the WCO provides a forum for cooperation so that customs authorities can become responsively involved and pro-actively contribute to global challenges, such as fighting pandemics, contributing to sustainable development or being part of the circular economy.

This evolution of the WCO, therefore, marks the transformation of the organisation into a global governance organisation that sets priorities and agendas for international cooperation. It further builds and fosters customs communities around programs, processes and region-specific issues. To answer these challenges the WCO develops data governance and uses agility, knowledge capture and knowledge sharing. These processes bring the organisation closer to the knowledge organisations as we know them today.

### 3. Knowledge as a capital for the customs community

In 1959, Professor Peter Drucker first discussed the idea of the ‘knowledge work’ in his book *Landmarks of Tomorrow* (Drucker, 1959). His followers observe that, at least as early as the 1980s, he was convinced that knowledge was a crucial economic resource that leads to a ‘post-capitalist society’ (Wartzman, 2014). For those who believe in the knowledge society, the time of a societal shift has come. The world is living through a transformation from an economy where individuals are considered as a ‘cost’ for their organisation, to an economy driven by knowledge capital.

#### 3.1 Knowledge as a capital: the knowledge organisation

The European Commission, in its *Communication on data, information and knowledge management*, considers knowledge ‘to be acquired through analysis and aggregation of data and information, supported by expert opinion, skills and expertise, and also to be provided as a valuable resource to help the decision-making’ (European Commission, 2016, p. 2). Knowledge can be tacit, in which case it resides in a person and it is difficult to articulate, or explicit, in which case it is easier to articulate, codify or access (European Commission, 2016, p. 2).

Data for knowledge could be organisational data assets, meaning data that has already shown value for the organisation. It could also be other data. However, knowledge is always related to the human mind.

Knowledge could become an asset once it acquires value by any possible means, for instance:

- ‘network effect’ (Sumbal et al., 2019), where knowledge generates social value when it passes by or is exchanged over a network, including people, data, computers,
- ‘collective intelligence’ (EU Science Hub, 2019), where knowledge is generated thanks to diversity of views, backgrounds and variety of interactions in teams,
- fostering knowledge in different forms of collaboration,
- leveraging knowledge in order to foster organisational capability to act.

In this way, knowledge becomes a self-fulfilling prophecy because once captured, generated, fostered, traced or shared by people and/or machines, knowledge could create more knowledge.

Leveraging knowledge, knowledge capability and the use of knowledge assets moves an organisation from a knowledge-management organisation to its next level: knowledge organisation. ‘Knowledge capacity building, knowledge capabilities, and knowledge capital are the critical success factors for a transition from an industrial into a knowledge economy’ (Ceruti et al., 2019, p. 10). Furthermore,

a knowledge organization actively and deliberately cultivates its knowledge capital, supports fundamental knowledge capabilities as organization-level functions, and consciously and deliberately leverages knowledge in every aspect of its business operations and processes. (Ceruti et al., 2019, p. 25)

The WCO's practices stimulate an extended collaboration among stakeholders and multi-disciplinary views on issues. Collaboration with academia suggests a shift towards collaborative scientific research methods. The combined use of these practices has the potential to foster a more transformative role of knowledge in the organisation. And that is the place from which to leverage customs knowledge through a knowledge-based ability to act.

### **3.2 Knowledge management for Customs**

Knowledge management in an organisation is about setting up a holistic system to use data and to create and stimulate collaborative, multidisciplinary interventions among people. It relies on a specific mixture of knowledge, technology, data and the specific organisational culture.

Knowledge management covers the interaction between the:

- data ecosystem of Customs
- collaborative and cooperation culture of customs administrations
- tools and technology that facilitate and enables these processes.

While the data ecosystem captures and develops data assets, collaboration adds knowledge and optimises the value of knowledge. Organisational culture is important in bringing the digital and technological and collaborative sides together. That is why modern organisations recognise the power of 'collective intelligence' (EU Science Hub, 2019) where the knowledge generated by teams is enriched through the team variety, the trust and the interactions among team members.

Entrusted with multiple border management functions and facing the challenge of balancing the effectiveness of controls with the interests of legitimate trade, Customs deals with both structured and unstructured data—with data from various sources—often generated in technologically empowered global supply and value chains.

To perform these roles, Customs needs digitalisation with sophisticated IT governance programs with embedded IT portfolio management as well as project governance and benefits management programs. Knowledge-management programs, with their inherent link to business processes, could be a useful tool to stimulate customs digitalisation.

### **3.3 Data governance and knowledge management**

To perform their functions, Customs is enabled by a rich data ecosystem that involves national and regional authorities, WCO-enabled digital environments, and digital and non-digital forms of knowledge sharing. Customs needs data governance programs to harness the power of data and digitalisation.

Collaboration is the main link between knowledge management and data governance programs. According to established data governance standards (Dama International, 2018), collaborative readiness is a typical part of an organisation's performance readiness assessment, which tests the information management capabilities, maturity and effectiveness of data governance programs. The absence of proper collaborative practices and collaborative culture in an organisation affects the performance of key data roles, impedes the generation of knowledge assets and ultimately affects an organisation's ability to act.

In addition, there is a link between data modelling (a critical component of data governance) and data analysis, on the one hand, and customs risk management and knowledge retention on the other.

Metadata is crucial both for data governance and for knowledge management. Managing metadata has been recognised as a knowledge management challenge but also a risk management necessity (Dama International, 2018’).

Cooperation between border agencies, exchange of information between the customs office of first entry and subsequent customs offices, and data sharing between Customs and economic operators, requires access to national data repositories, data re-use, and access to data created by the public sector or by economic operators.

Knowledge accumulation happens more easily in digitally enabled trade. It is, however, challenging to find the relevant knowledge, use it as evidence and measure the impact of its use continuously. Measurement of impacts is ever more difficult when data from different sources, provided by different actors and organisations, is used, as is the case with integrated border management.

Finally, the availability of big data stimulates the co-existence of knowledge from different sources. It is necessary for Customs to be able to establish the source and relevance of such information and knowledge.

## 4. Knowledge management at the WCO

*We are a knowledge-based and action-oriented organization* (WCO, 2019a).

### 4.1 WCO: mission and values

A ‘knowledge-based’ and ‘action-oriented’ organisation describes a primary value for the WCO. It addresses a policy and an objective for the organisation. In policy terms, ‘knowledge sharing’ has already been implemented as a strategic priority and is embedded in its collaborative practices. As an objective, the value statement sets the ambition to leverage knowledge into the capability to act for the WCO as an organisation, for its members and for the global customs community. These are also the values of the knowledge-management community and the practices of knowledge-management.

The mission of the WCO is further supported by the values of:

- transparent, honest and auditable governance procedures
- responsiveness to WCO members, stakeholders in trade, and society
- capitalisation on technology and innovation.

### 4.2 WCO data ecosystem and digital environment

The WCO has developed a rich ecosystem of data and knowledge sources designed for its diverse stakeholders from customs authorities, other international organisations, trade, and academia. Their involvement and collaborative interactions indicate the increasing importance of the external dimension of knowledge management. Such examples are:

- the use of digital platforms to share knowledge in the framework of the WCO Customs Knowledge Academy
- the extended collaboration during the elaboration of the WCO Cross-Border E-Commerce Framework of Standards (WCO, 2018a).

The data ecosystem extends to the WCO’s external relations with its stakeholders. For instance, it was noted in 2015, with the advance of the internet of things, that ‘customs would need to create an operating model that captures big data from across the industry ecosystem’ (WCO, 2015).



Digital platforms and other knowledge-adapted technological innovations allow customs organisations to tap into the potential of digitalisation and use it for knowledge cocreation and knowledge sharing. Data, knowledge, technology and culture do not individually shape a knowledge-management strategy; it is the right combination of those elements, as adjusted to the needs of Customs, that does.

### 4.3 Collaboration

Collaboration is an integral part of the WCO's culture as it nurtures relationships with its members and partners and is responsive in its decision-making processes.

Collaboration in the framework of WCO processes and activities evolved both vertically and horizontally. The political dimension of the WCO decision-making bodies is the main example of vertical collaboration. Horizontal collaboration, on the other hand, develops in the framework of capacity-building and Customs-to-Customs cooperation.

Apart from more traditional forms of cooperation, new ways of working may gain ground in the framework of the WCO. The regional workshops of WCO members to discuss organisational development is an example of such practices.

Working groups and various discussion forums with external stakeholders from trade and academia foster knowledge. The results of their activities could be used for innovative knowledge cocreation, as could the collaborative research among the WCO Research Unit, academia and the private practitioners.

The variety of collaborative practices among diverse combinations of stakeholders is a useful ground for innovative methods of discussions, working together and collective knowledge generation. The more they become inherent in the culture of the global customs community, the easier it would be to use innovative forms of decision-making in the WCO's decision-making.

## 5. The future of the WCO as a knowledge organisation

*We need to move from 'need to know' to 'need to share'.*

—Ursula Von der Leyen, President of the European Commission

### 5.1 From 'need to know' to 'need to share'

To paraphrase the statement of the EU Commission's president, digitalisation and knowledge management are two sides of the same coin. This starts with a different mindset: we need to move from 'need to know' to 'need to share'.

Sharing knowledge and best practices is a strategic objective of the WCO. The number of missions, events and workshops are key performance indicators for its measurement (WCO, 2019a, p. 10). In addition, programs for technical assistance for capacity building and customs cooperation processes and programs suggest a significant demand for knowledge sharing. Sharing best practices and benchmarking creates a favourable environment for knowledge capture, knowledge fostering and knowledge co-creation.

By being open to the research community and to private practitioners, the WCO creates an environment for external knowledge sharing. Examples can be found in the WCO activities that support the learning and development strategic objectives of WCO processes (WCO, 2019b, p. 5):

- the prevalence of IT solutions and use of technology and data and development of the data analysis and IT tools of customs organisations
- raise the profile of WCO and promote Customs' role through reaching out to other international organisations and partners.

## 5.2 Global knowledge and external knowledge management

The key performance indicators for sharing knowledge and best practices for the WCO are (WCO, 2019b, p. 5):

- compendiums, such as the AEO Compendium or the Single Window Compendium
- number of missions, meetings, events and workshops organised by the WCO
- exchange of best practices, particularly in relation to customs procedures.

The WCO's ambition is to build on these activities, to improve 'global knowledge' and extend good practices 'to a larger number of Customs administrations in many areas'. This process also has a qualitative dimension. Knowledge sharing requires an environment that creates trust among participants, in relation to both data and information security and the way in which collective thinking is nurtured and used to foster knowledge.

As is the case with other international organisations, the WCO would face a stronger demand for a wider knowledge sharing in an external dimension. This external dimension involves members as well as other stakeholders.

## 5.3 Partnership and network management

Cross-cutting issues have a specific place in the WCO policy and actions. So are cooperation, Customs-to-Customs cooperation, benchmarking, exchange of best practices and cooperation in the form of technical assistance and capacity building.

The WCO's activities are organised in interlinked processes and this paves the way for a transformation, which Dupont (2020) calls 'a multi-layered system of partnerships or networks, yielding an open problem-solving transnational cooperation', where these partnerships or networks are 'either providing scale or resilience, but some may be oriented toward some specific, and time limited, tasks'.

Through collaboration and partnership, the WCO would develop the knowledge-management action and foster its knowledge-based capability to act as a centre of the global customs community.

## 5.4 Role of communities of practice

Communities of practice, also known as competence centres, are widely accepted as a key knowledge management enabler. They are described as groups of people 'informally bound together by shared expertise and passion for a joint enterprise' (Wenger & Snyder, 2000). Such communities provide 'a rich locus for the creation and sharing of knowledge both within and between organisations' (Usuro, et al., 2007, p. 200).

Communities of practice and network communities, created through partnership and collaboration, increase the dynamic capabilities of the WCO. If used and established, they would enable the leverage of customs knowledge into an infinitely renewable knowledge capital.

## 6. Conclusion

The world of international organisations may soon be different from the one that we know. Under unprecedented challenges for global intergovernmental cooperation, the international legal order may give way to a new form of international governance.

Knowledge management is a suitable instrument to drive such a transition. In the minds of knowledge practitioners and believers in collaboration and cooperation, it has championed a decade-long transformation towards a knowledge society and a knowledge-driven economy.

The WCO has embraced the knowledge management change by embedding knowledge fostering, knowledge co-creation and knowledge sharing into its processes, programs and activities. Knowledge sharing is at the heart of its mission and values.

By nurturing dynamic and diverse forms of external knowledge sharing and collaboration, the WCO has paved the way to leverage customs knowledge into actions to the benefit of the global customs community. It is the knowledge-enabled ability to act that transforms the role of the WCO in an emerging new governance for the global customs community. If the WCO embraces this challenge with a wide variety of tools, such as communities of practice, it could make the best use of knowledge assets and leverage them for future actions.

And that is what knowledge organisations do.

## References

- Ceruti, M., Williams A., & Bedford, D. (2019). *Translating knowledge management visions into strategies (working methods for knowledge management)*. Emerald Publishing Limited.
- Dama International. (2018). *DAMA-DMBOK, Data Management Body of Knowledge* (2nd Edn.). Technics Publication.
- Drucker, P. (1959). *Landmarks of tomorrow*. Transaction Publishers.
- Dupont, C. (2020, February 20). The future of international organisations. *Executive Education Newsletter*. Graduate Institute Geneva. <https://graduateinstitute.ch/communications/news/future-international-organisations>
- European Commission. (2016). *Communication to the Commission: Data, information and knowledge management at the European Commission*. <https://ec.europa.eu/transparency/regdoc/rep/3/2016/EN/C-2016-6626-F1-EN-MAIN.PDF>
- EU Science Hub. (2019). *Understanding our political nature: How to put knowledge and reason at the heart of policymaking*. <https://ec.europa.eu/jrc/en/facts4eufuture/understanding-our-political-nature>
- Sumbal, M.S., Tsui, E., Irfan, I., Shujahat, M., Mosconi, E. & Ali, M. (2019). Value creation through big data application process management: the case of the oil and gas industry. *Journal of Knowledge Management*, 23(8), 1566-1585. <https://doi.org/10.1108/JKM-02-2019-0084>
- Usuro, A., Sharatt, M., Tsui, E., & Shekar, S. (2007). Trust as an antecedent to knowledge-sharing in virtual communities of practice. *Knowledge Management Research and Practice*, 5(3), 199–212.
- Wartzman, R. (2014, October 16). What Peter Drucker knew about 2020. *Harvard Business Review*. <https://hbr.org/2014/10/what-peter-drucker-knew-about-2020>
- Wenger, E. C., & Snyder, W. M. (2000, January–February). Communities of practice: The organizational frontier. *Harvard Business Review*. <https://hbr.org/2000/01/communities-of-practice-the-organizational-frontier>
- World Customs Organization (WCO). (2015). *WCO News No. 78*. [http://www.wcoomd.org/-/media/wco/public/global/pdf/media/wco-news-magazines/wconews\\_78\\_uk.pdf](http://www.wcoomd.org/-/media/wco/public/global/pdf/media/wco-news-magazines/wconews_78_uk.pdf)
- World Customs Organization (WCO). (2018a). *Cross-border E-Commerce Framework of Standards*. [www.wcoomd.org/-/media/wco/public/global/pdf/topics/facilitation/activities-and-programmes/ecommerce/wco-framework-of-standards-on-crossborder-ecommerce\\_en.pdf?la=en](http://www.wcoomd.org/-/media/wco/public/global/pdf/topics/facilitation/activities-and-programmes/ecommerce/wco-framework-of-standards-on-crossborder-ecommerce_en.pdf?la=en)

World Customs Organization (WCO). (2018b). *SAFE Framework of Standards*. 2018 edition. <http://www.wcoomd.org/-/media/wco/public/global/pdf/topics/facilitation/instruments-and-tools/tools/safe-package/safe-framework-of-standards.PDF?la=en>

World Customs Organization (WCO). (2019a). *Strategic plan 2019–2022*. <http://www.wcoomd.org/-/media/wco/public/global/pdf/about-us/administrative-documents/wco-strategic-plan-2019-2022.pdf?db=web>

World Customs Organization (WCO). (2019b). *Implementation plan 2019–2020*. <http://www.wcoomd.org/-/media/wco/public/global/pdf/about-us/administrative-documents/wco-implementation-plan-2019-2020.pdf?db=web>

### **Jenia Peteva**



Jenia Peteva is a Policy Officer in Revenue Administration at the European Commission. She contributes to the improvement of the efficiency and the digital transformation of the customs and tax administrations of the member states of the European Union. Previously, Jenia was a member of the Secretariat of the Information and Management Steering Board of the European Commission, where she was involved in shaping the data governance and knowledge management policy at the European Commission.

For more than 10 years she worked on trade and customs law and policy where she was in charge of matters of customs import and export procedures, e-commerce, customs risk management; as well as and import and export controls for animal health.

Disclaimer:

The European Commission is not liable for any consequence stemming from the reuse of this publication.

The views expressed in this publication are the sole responsibility of the author and do not necessarily reflect the views of the European Commission.

# Machine learning for detection of trade in strategic goods: an approach to support future customs enforcement and outreach

*Christopher Nelson*

## Abstract

---

Customs authorities have a critical role in identifying trade in strategic goods that could have an adverse impact on international security. This study proposes a method of using data resampling and the Random Forest machine learning algorithm to model common patterns and characteristics that separate transactions involving strategic goods from broader international trade flows. By embracing advances in machine learning and computing power, customs authorities can leverage existing data to improve enforcement and outreach efforts related to strategic goods subject to international export control regulations.

---

## 1. Introduction

Customs authorities must balance facilitation of legitimate trade with the obligations of international security. As the volume of international trade has increased over the years, states have taken many steps to improve efficiency in both trade facilitation and detection of fraudulent activity. There remains, however, a gap in the ability of states to identify potential instances of illicit trade in strategic goods. The World Customs Organization (WCO) defines strategic goods as ‘weapons of mass destruction (WMD), conventional weapons, and related items involved in the development, production, or use of such weapons and their delivery systems’ (WCO, 2019, pp. 8–9). While comprising a small amount of overall international trade, these commodities represent an essential piece of the international customs security mission.

Advances in data collection and computing power provide the opportunity to analyse the vast amount of data collected by customs authorities every day through shippers’ export declarations. This study proposes that machine learning techniques can profile trade in strategic goods, identifying patterns that may allow customs authorities to more effectively recognise these transactions. A longstanding issue with identifying trade in strategic goods has been the difficulty in correlating the Harmonized System (HS) codes to export control classification numbers. The approach proposed in this study would use transaction records to identify how HS codes are being utilised for strategic goods in order to detect this behaviour in the broader context of trade not subject to export control licensing requirements.<sup>1</sup>

Utilising resampling and the Random Forest algorithm, this study proposes that customs authorities can use supervised learning techniques to identify the signatures of strategic goods based on transaction data. This approach would create models for a portfolio of high-priority strategic goods, considering state-specific traits, such as trading partners and the domestic industrial base. These models could be used to identify entities that are shipping commodities that match the characteristics of a strategic good but have not sought out the proper export licence. In addition, they could be used to improve outreach efforts, identifying where entities did not seek a licence and promoting more accurate HS code classifications.

By embracing recent advances in machine learning techniques, data collection and computing power, customs authorities would be in a better position to identify and respond to strategic trade flows in the future.

## 2. The problem

Strategic goods comprise a wide range of dual-use commodities that have legitimate commercial uses, such as chemicals, materials, electronics and manufacturing equipment. This study considers strategic goods to be those items subject to national or international export control regimes, such as the Wassenaar Arrangement, Nuclear Suppliers Group, Australia Group, and others. These regimes outline the agreed upon commodities and the technical parameters that elevate the item to a controlled commodity requiring a review by state authorities before export. Examples of strategic goods include high-end machine tools, mass spectrometers, radiation hardened integrated circuits, carbon fibre and rocket propulsion systems.

In attempting to identify and regulate trade in these strategic goods, state authorities need to create an effective licensing and enforcement process that can undertake tasks such as identifying relevant transactions, assessing end-users and proposed end-use, and uncovering violations. Individual state regulations, international agreements and partnerships commit states to putting effective systems in place to control strategic goods. United Nations Security Council Resolution (UNSCR) 1540 was a major step forward in strategic trade controls, requiring states to prevent the unregulated transfer of WMD-related commodities. However, when it was initially implemented in 2004, most states lacked an effective system of identification and control, particularly if ‘these goods were intentionally routed around national licensing authorities’ (Perry, 2019, p. 10).

Identifying trade in strategic goods is a difficult problem for state authorities for many reasons. First, the volume of trade not subject to export control requirements is vastly larger than trade in strategic goods. As an example, in 2018, the United States had approximately \$1.7 trillion in total exports. Of that, \$44.6 billion, or 2.7 per cent, were exported under a government licence (US Department of Commerce, 2018). This imbalance, which varies by state and commodity, makes it very difficult to identify relevant transactions amid the noise. In addition, the main classification systems for international trade and strategic trade have different objectives and do not correlate well. The lack of a universally applicable and accepted system that can delineate trade not subject to export control requirements and strategic trade is one of the key drivers for the approach outlined in this study. State authorities must also consider efforts to obfuscate the commodities being traded, transshipment through different states, and lack of knowledge by the entities trading the goods. The massive amount of data collected in the course of international trade has compounded these issues, making traditional data or risk analysis an unwieldy undertaking.

State authorities have taken a variety of approaches to improving the effectiveness of customs targeting. In general, many state authorities focus on identifying misclassifications in order to ensure they collect proper import taxes and duties from goods entering their country. A traditional approach has been to identify trade gaps between the value reported by the exporting country and the value declared upon import. Using available international trade statistics, these gaps can help identify under or overvaluation for commodities and help target customs enforcement (Chalendard, 2017, p. 12). Another common approach is risk rating shipments based on factors such as country of origin, commodity type, entity profiles and tolerance measures. This relies on in-depth past knowledge to create risk profiles and accuracy in the declarations for the system to work reliably. State authorities can also utilise pre-shipment inspection processes in which importers (and to an extent the exporters) are required to engage private companies to inspect the cargo and ensure that it fits the declared quality, quantity and price (Dictionary of International Trade, n.d.).

The WCO has created the *Strategic trade control implementation guide*, which outlines the different stages of an effective state-level control system. These steps provide a starting point for states to set goals and measure progress toward an effective customs system. At the Established Capability phase, there are ‘established outbound enforcement teams capable of targeting and inspections’, ‘national risk management (targeting) centers’, and the ability to process intelligence tips to inspect and/or interdict (WCO, 2019, p. 16). An Enabled Capability goes further, adding synthesis between licensing and customs capabilities and regular feedback loops and coordination mechanisms. The WCO guide outlines best practices for these areas, but it is ultimately up to the state to implement the specific procedures.

Efforts in utilising past trade records and customs declarations have also moved forward. State authorities already collect and maintain a massive amount of trade data, from licensing information to bills of lading. For example, the Hong Kong China Customs’ Central Information Repository data warehouse increased in size from three terabytes in 2012 to 12 terabytes in 2015 (Okazaki, 2017, p. 11). These records contain a wealth of data that can assist in identifying the signatures of a transaction, such as value, weight, quantity, HS code, destination, consignees, and export control numbers. The key question is how can state authorities get a handle on this increasing volume of data? In addition, how can the small amount of strategic trade be identified within the massive amount of transactions? Leveraging machine learning algorithms and the increasing computing power to handle larger and larger datasets can help state authorities take a meaningful step toward the future of more effective commodity identification and transaction targeting.

### 3. Identifying strategic goods amid the noise

The nomenclatures to track trade generally, and strategic goods specifically, were designed with different fundamental objectives and therefore do not correlate well. This non-alignment is the core of the strategic trade control problem and has been the focus of many research efforts and studies. First, the HS is a universal classification system designed to facilitate tariffs. Since these codes are uniform for all parties, ‘the Customs’ clearance process is expedited, tariff collections are readily determined, and commercial disputes like levying inappropriate duties due to misclassification of traded goods are avoided’ (Kim, 2017, p. 71). On the other hand, strategic trade controls are designed with the objective of regulating the flow of specific commodities with specific parameters in specific use cases or destinations. The inherent structure of both systems are different:

In [strategic] trade controls, multiple dimensions such as functions, raw materials, and industrial specifications are considered together in the licensing process while the HS begins by classifying goods based on a specific industrial sector and then hierarchically drills down (Kim, 2017, p. 74).

Attempting to correlate export control classification numbers (ECCNs) for strategic goods with their pertinent HS code is an extremely difficult task. The HS–ECCN relationships that would easily identify strategic goods are rarely one-to-one. In fact, a strategic good can be potentially shipped under a host of HS codes and an HS code could contain multiple ECCNs. There are almost never technical specifications in HS code descriptions, which are the key delineating factor on strategic control lists. In some cases, such as uranium, nuclear fuel, or certain materials, the HS code closely correlates to a controlled item. For example, depleted uranium matches exactly to HS code 284430, ‘uranium depleted in U235’. Most strategic goods, however, are indistinguishable in the HS description from a mixture of other commodities included in the code that are not strategic goods. As a result, even states ‘with advanced export control systems where companies have strong export compliance programs in place had been unable to prevent insiders from diverting illicit dual-use transfers’ (Perry, 2019, p. 10).

On top of this ambiguity, entities self-declare the relevant HS code and can easily make a mistake or intentionally misclassify their goods, making identification even harder. Entities identify the HS code of the commodity they are trading in their shipping documents with little oversight as to the accuracy of

this declaration. If an error is made by the trading party due to a misreading of HS codes, it may not be detected by customs authorities. In addition, some entities may intentionally misclassify the HS code of their commodity to avoid export licensing requirements or tax burdens, or for general subterfuge. The nature of how HS codes are declared in shipping documents contributes to the difficulty of identifying trade in strategic goods.

Companies utilise the HS to identify their shipments and customs officers rely on these declarations to assess duties/taxes and potentially target shipments for inspection. Without a direct HS–ECCN connection, how are customs inspectors supposed to identify shipments of strategic goods when a shipper has not declared it as such? It is possible to create approximate correlation tables through research and subject matter expertise, as is the case with the European Commission’s *Correlation list between TARIC and the dual-use annex of the Regulation 428/2009* (European Commission, 2020). These are extremely useful guides but are often not backed by real-world shipment data. They do not allow for any systematic review of transactions for misclassification. Strategic goods shipped under the incorrect HS code can only be found through other risk mitigation strategies, such as targeted inspections, end-use checks and entity profiles. These correlations cannot be deployed to find illicit trade in strategic goods on a large scale.

A potential solution lies in the data that states and their customs authorities currently maintain. States could exploit existing data gathered from shipping declarations to create a data-driven system to target strategic goods. Machine learning techniques can amplify traditional analytic approaches to provide predictive classifications to create strategic commodity profiles utilising attributes such as the ECCN, HS code, value and quantity. The approach detailed in this study would use previous export data of commodities that have an ECCN in the shipping documentation along with shipments of commodities not subject to export licensing requirements within the same basket of HS codes to create a model to identify the key characteristics of shipments of a specific strategic good.

## 4. Machine learning for detection of strategic goods

Machine learning is ‘centered around making predictions, based on certain trends and patterns that have been already identified through data analytics’ (Okazaki, 2017, p. 7). From this definition, we can create a path to what states would ideally like to do regarding strategic trade: predict whether a particular transaction matches a pattern that indicates it could be a strategic good that needs to be regulated.

In this case, states would take historical export transactions and use attributes such as value, quantity, destination, and HS code to train a model to classify whether a new transaction is likely to be subject to strategic trade controls. Doing so would allow authorities to be proactive in identifying critical transactions for enforcement or outreach on a wide scale. Since machine learning relies on models that can adapt to new data, it refines itself over time. In addition, since we can use transaction data that we know involve strategic goods, we will have various ways to check the performance of our model.

Applying big data analysis or machine learning to international trade data is not a new concept. One method to identify misclassification or tax avoidance is to utilise mirror trade statistics. By comparing an exporting state’s declaration with information from the importing state, authorities may be able to detect patterns of under or overvaluation, identifying transactions or commodities where entities commonly avoid taxes or duties (see Chalendard, 2017; Cariolle et al., 2018). In other cases, the simple use of historical transaction data may allow authorities to recognise patterns in new transactions that indicate strategic goods or tax/duty evasion (see Digiampietri et al., 2008; Chalendard, 2017). Recent studies by Chermiti (2019) and Zhou (2019) apply different approaches to decision tree algorithms in customs risk detection and profiling. The approach proposed in this study expands upon aspects of these past efforts but focuses on the identification of strategic goods rather than the risk of duty evasion.



## 5. Data collection and preparation

Classifying transactions involving strategic goods lends itself to solutions developed for a relatively common machine learning problem: outlier detection. Outlier detection is used for a wide variety of applications, such as credit card fraud, suspicious traffic in cyber security, disease detection, and many other problems where we seek to find ‘patterns in data that do not conform to expected behavior’ (Singh & Upadhyaya, 2012, p. 307). Since strategic trade is such a small proportion of overall trade, we assume these transactions are not the norm and can be considered outliers. This approach in analysing international trade has been taken before, but primarily to detect tax/duty avoidance during the import of goods rather than the detection of strategic trade (see Digiampietri, 2008; Laporte, 2011).

The two key aspects of an outlier are that ‘They are the minority consisting of few instances, and they have attribute-values that are very different from those of normal instances’ (Liu et al., 2012, p. 2). As mentioned previously, in the United States in 2018, only 2.7 per cent of global exports were exported under a government licence. Trade in strategic goods is rare when compared to all international trade. Since strategic goods are controlled for their specialisation, advanced technology or technical parameters, they tend to have distinctive characteristics compared to commodities shipped under the same HS code or set of HS codes such as tending to be shipped in lower quantities at higher values. If strategic goods were not comparatively rare, the export controls involved would be mute. An international trade control ‘becomes inapplicable when an item is too commonly traded, and items can be de-listed for this reason’ (Chatelus & Heine, 2016, p. 52).

The first step is to identify the strategic good that the customs authorities want to prioritise and create a model for, based on its ECCN. After the ECCN is identified, data for controlled export transactions that identify this ECCN in the shipping documentation would be pulled together for a given timeframe. This timeframe could be decided based on the amount of data or other considerations, such as regulation changes, end-use destination or geopolitical events. Once this data is gathered, we would create a ‘basket’ of the different combinations of the ECCN and HS codes. This basket would show how often a particular HS code is utilised by exporters for transactions involving the particular ECCN (e.g. 45% of transactions involving strategic goods classified under ECCN X were shipped using HS code Y). This allows us to identify the HS codes that are *actively being used* for transactions involving a strategic good rather than relying on a correlation table that says what the HS code for a strategic good *should be*.

An example of a such a basket for maraging steel (ECCN 1C116) is in Table 1. Note that the percentages are examples only and not based on actual transaction data.

Table 1: Example HS basket for maraging steel (ECCN 1C116)

HS code	Percentage of transactions
720429	45%
722692	17%
722090	15%
722810	11%
720521	7%
721129	2%
722540	1%
731822	1%
210690	1%

Source: Zaub.com for HS codes

The gathered ECCN–HS correlations often contain codes that are utilised at a low rate. This may be due to misclassification, an outlier case, or other issues. In subsequent steps, transactions of commodities not subject to export licensing requirements for these HS codes will be gathered. As such, a reasonable cut-off point should be set so as to not include a large amount of transactions that may be irrelevant just because the HS code is in the basket. For example, a cut-off could be set at 10 per cent—only HS codes utilised in 10 per cent or more of the transactions with an ECCN would be included in further analysis. Table 2 shows the revised example basket for maraging steel with a 10 per cent cut-off.

*Table 2: Example HS basket for maraging steel with cut-off*

HS code	Per cent of transactions
720429	45%
722692	17%
722090	15%
722810	11%
720521	7%
721129	2%
722540	1%
731822	1%
210690	1%

*Source:* Zaubacom for HS codes

Once the most used HS codes are identified, data would be pulled from all transactions with commodities not subject to export licensing requirements with these codes for the same time period from which we drew the transactions with ECCNs. This assembles the universe from which we can model the characteristics of trade in the particular strategic good as opposed to the transactions with commodities not subject to export licensing requirements. This assembles a set of known transactions involving strategic goods and commodities not subject to export licensing requirements with known outcomes, becoming a supervised learning exercise. Since we know the ultimate content of each transaction, we can test how well our models perform in predicting classifications.

Customs authorities gather a large amount of information from international trade transactions. There are many attributes included in a shipper’s export declaration or bill of lading that could be useful in the process of attempting to identify trade in strategic goods. Machine learning algorithms can handle large numbers of disparate features and there are techniques to select the most impactful factors in determining the ultimate classification through feature selection, which is beyond the scope of this study. As a baseline, some key features for analysis could be:

- quantity
- net shipping weight
- monetary value
- HS code
- ultimate destination.

## 6. SMOTE resampling

In gathering the set of transactions identified above, transactions with commodities not subject to export licensing requirements will outnumber the transactions that have an ECCN for the targeted commodity. In machine learning, imbalanced data can have adverse effects on modelling. For example, if it is assumed that every transaction does not involve a strategic good there may be a very high accuracy rate, but we will miss the objective of this approach to detect the minority class. To identify the outliers in the broader volume of international trade it is necessary to resample our data. In this case, the resampling will bring the minority class into balance with the majority class, which allows for better performance of modelling.

The techniques for resampling involve undersampling the majority class or oversampling the minority class. Undersampling would involve removing transactions with commodities not subject to export licensing requirements at random to bring the data in balance with the number of transactions involving strategic goods. This could omit valuable information that would distinguish the categorical differences that could delineate strategic goods. Oversampling would involve duplicating transactions involving strategic goods to match the amount of transactions with commodities not subject to export licensing requirements. This could create an overemphasis on certain characteristics, overfitting the model to specific transactions creating a model that might not fit in accurately predicting new cases.

A balanced approach that has shown impressive performance in handling imbalanced data is the Synthetic Minority Oversampling Technique (SMOTE). This approach identifies similar examples in the minority class and creates new instances that share the space between them. Rather than duplicating transactions to oversample, this technique provides ‘new’ examples of the minority class. As the originators of this approach summarise, ‘With replication, the decision region that results in a classification decision for the minority class can actually become smaller and more specific... This is the opposite of the desired effect. Our method of synthetic over-sampling works to cause the classifier to build larger decision regions that contain nearby minority class points’ (Chawla et al., 2002, p. 352).

## 7. Machine learning with random forest

Once prepared, the data is ready to be used to create a model for classifying transactions involving strategic goods. A minority portion of the collected dataset should be set aside for unbiased testing of the model once it is trained on the data, which will provide a measure of performance.

This study proposes the use of the random forest algorithm to predict whether a transaction involves a strategic good. Originally proposed by Breiman (2001), this model creates many decision trees based on randomly selected features and data samples to determine the classification of a transaction. A decision tree tests one feature at each decision node, splitting into sub-nodes in order to maximise the homogeneity of the resulting groups. It continues splitting until it can put the data, with a high probability, into a leaf that identifies the classification of the record. Decision trees have the advantage of being more easily visualised and interpreted than other classification algorithms. Random forest expands this model by creating hundreds or thousands of randomly generated trees using different features and subsets of data. In our case, each tree would generate a prediction for each transaction and the final classification would be decided by a majority vote. Figure 1 presents a simplified representation of the random forest algorithm. Our models would be a binary classification; either the transaction is classified as involving a strategic good or not. In Figure 1, two trees predict that the transaction does involve a strategic good and one does not, therefore the overall prediction is that there is a strategic good involved.

Figure 1: Random forest algorithm

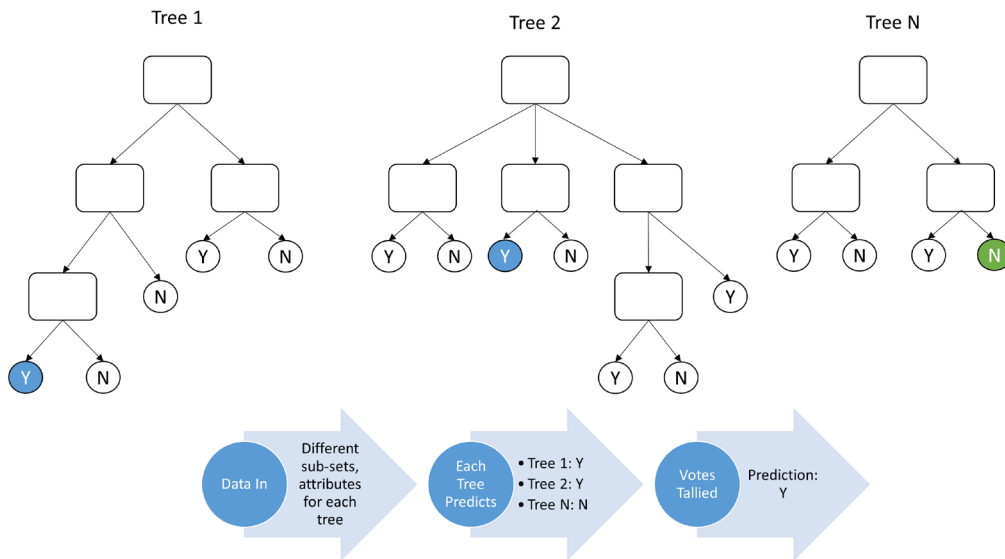

This algorithm has many advantages. By utilising random samples of features and data over many trees, it can help prevent overfitting the model. Individual decision trees, unless pruned or controlled, can continue splitting the dataset in increasingly specific ways, creating a very specific model that cannot generalise to new data. In addition, random forest is very versatile, handling categorical and numeric data. Many machine learning algorithms require workarounds for categorical data. Applications of this algorithm also provide an ability to identify the importance of individual features to the final classification. This would allow the identification of which aspects of transactions, such as destination, HS code or value, are most valuable in predicting whether a transaction involves a strategic good. By utilising a multitude of trees, no individual test of the data will predominate, increasing confidence in the ultimate classification. Random forest can be computationally expensive; however, parameters of the algorithm may need to be adjusted for the amount of data involved.

The algorithm would be trained on the data and performance would be measured against the reserved test set, which has a known classification. Based on the test, parameters or features could be changed to increase performance. This model would apply to a particular strategic good. After the approach has been tested, it can be used iteratively to create models for a broad portfolio of strategic goods based on a state-level risk or priority assessment. Also, once these models are created, they could be applied as new data arrives. Pre-shipment data or shippers' export declarations would be inputted into the models to determine if the transaction is likely to contain a particular strategic good. The creation of multiple models has the advantage of taking into account the characteristics of particular commodities in addition to providing a prediction of which particular strategic good may be involved. A general model identifying if any strategic good was likely involved in a transaction would mix a multitude of very disparate commodities that have varying levels of risk or priority.

## 8. Benefits, potential applications and next steps

Given the data-dense nature of international trade transactions, customs authorities around the world are in an excellent situation to exploit advances in machine learning to improve risk analysis, enforcement and outreach. As more transactions are recorded every day, the models created to classify strategic goods

can improve, be adjusted and reworked under the same methodological construct. In addition, since this approach proposes the use of state-centric data, the models will inherently be designed to identify strategic goods in the context of that state, taking into account geography, trading partners and industrial capabilities. The recent expansion of distributed computing and cloud-based services allows for state authorities to analyse and create models for a much larger portion of data that could be handled even five to ten years ago.

Beyond better handling of data, the ongoing advances in machine learning algorithms and techniques continues to push the boundaries of classification predictions. The random forest algorithm was first introduced in 2001 and further refinements to it and other models continue constantly (Breiman, 2001). Random forest was chosen for this proposal because it can handle a wide range of data types and can also identify the most important features to the classification of a transaction as involving or not involving a strategic good. Practical testing may find other methods to provide better performance or efficiencies, but this is exploration and could be very fruitful in many customs analyses.

The classification of transactions involving strategic goods has a wide variety of useful applications for states. From an enforcement perspective, this approach would allow for better profiling of transactions involving strategic goods using real-world data. Reliance on the accuracy of licence applications and proper HS code declarations is often inaccurate for a variety of reasons. Training a random forest model on transactions declared to be a strategic good and those that are not can allow for identification of patterns that delineate the transaction types. Once trained and refined, these models could be applied to incoming transactions, thereby enhancing risk profiling and potential documentation or end-use checks. Modelling based off a select set of high-priority strategic goods could enhance resource allocation and provide data-based justifications for inspections. This approach would also allow for states to better understand common trade flows for strategic goods and identify potential transshipment points. The random forest model can consider the origination and destination points of the transactions. If a particular trading point appears as a key node in the model, it may assist in enforcement targeting or outreach efforts.

In addition to enforcement, this approach could be used to design outreach efforts that would cyclically improve overall customs efficiencies. First, based on the models trained through existing data, it would be possible to identify transactions that fit the profile of a strategic good, but were not licensed. The entities involved in these transactions could be identified for training on export control regulations and future end-use checks. Since this approach uses a basket of HS codes to identify how entities are shipping strategic goods, it could also be used to improve the way states and entities classify which HS codes are used in practice and which should be used in the trade of a strategic good. This could provide a baseline for how entities in a state are operating and how customs authorities might work with them and their international partners to make more effective use of the HS. If this approach proved effective, over time the data collected by customs authorities would be more comprehensive and accurate, thus improving the modelling over time. In addition, the exchange of strategic good transaction models with other trading partners could improve detection of relevant imports and sharing of best practices.

There are many potential next steps to test and improve this approach. This study was limited to a theoretical exercise based on the author's experience. The logical next step would be to apply this machine learning technique to state-level data. Based on findings from such an experiment, many refinements could be made, and the model could be tested against real-world data through a multitude of classification metrics. There are also many other cutting-edge machine learning techniques that could potentially increase performance and the range of applications. Advances in natural language processing could allow for models that include a breakdown of text-based fields on transaction descriptions, flagging for key words or terms related to strategic goods. The expansion of deep learning and neural networks as a machine learning approach has provided increased performance and flexibility in model building in many other fields of research. Neural network algorithms are more complicated than decision trees but can handle a wide range of input variables and have the ability to create non-linear and complex

relationships between variables. This approach could be explored to train more accurate models in predicting strategic trade transactions (Mahanta, 2017).

From bank fraud to disease detection to Netflix recommendations, machine learning has vastly expanded our ability to draw insights from large datasets. Detection of trade in strategic goods is a necessary but challenging task for customs authorities. The expansion of data processing abilities and machine learning techniques with subject matter expertise sets the groundwork for the future of Customs in this area. As proliferation and advancement in manufacturing and technology in nuclear, biological, chemical and weaponry continues, it is important to leverage advances in data-driven decision-making to meet the challenge.

## Disclaimer

This article was prepared by Christopher Nelson in his personal capacity. The views expressed in this article are the author's own and do not reflect the view of the New York State Office of the Attorney General or any other agency of the United States Government.

## References

- Breiman, L. (2001). *Random forests*. University of California. <https://www.stat.berkeley.edu/~breiman/randomforest2001.pdf>
- Cariolle, J., Chalendard, C., Geourjon, A. M., & Laporte, B. (2018). Measuring and improving the performance of customs valuation controls: An illustration with Gabon. *The World Economy*, 42(6), 1850–1972.
- Chalendard, C. (2017). Using internal and external sources of information to reduce customs evasion. *International Centre for Tax and Development*. ICTD Working Paper 62.
- Chatelus, R., & Heine, P. (2016). Rating correlations between customs codes and export control lists: Assessing the needs and challenges. *Strategic Trade Review*, 2(3), 34–67.
- Chawla, N., Bowyer, K., Hall, L., & Kegelmeyer, W. (2002). SMOTE: Synthetic minority over-sampling technique. *Journal of Artificial Intelligence Research*, 16, 321–357.
- Chawla, S., & Chandola, V. (2011). *Anomaly detection: A tutorial. Theory and applications*. University of Sydney & Oak Ridge National Laboratory. [https://webdocs.cs.ualberta.ca/~icdm2011/downloads/ICDM2011\\_anomaly\\_detection\\_tutorial.pdf](https://webdocs.cs.ualberta.ca/~icdm2011/downloads/ICDM2011_anomaly_detection_tutorial.pdf)
- Chermiti, B. (2019). Establishing risk and targeting profiles using data mining: Decision trees. *World Customs Journal*, 13(2), 39–57.
- Dictionary of International Trade. (n.d.). *Pre-shipment Inspection (PSI)*. <https://www.globalnegotiator.com/international-trade/dictionary/pre-shipment-inspection-psi/>
- Digiampietri, L., Roman, M., Meira, L., Filho, J., Ferreira, C., & Kondo, A. (2008). Uses of artificial intelligence in the Brazilian customs fraud detection system. *Proceedings of the 9th Annual International Conference on Digital Government Research*, pp. 181–187.
- European Commission (EC). (2020). *Correlation list between TARIC and the Dual-use Annex of the Regulation 428/2009*, EC, Brussels. <https://trade.ec.europa.eu/doclib/html/155445.htm>
- Kim, H. (2017). Enhancing the interface between the harmonized system and strategic trade controls. *Strategic Trade Review*, 2(3), 69–84.
- Laporte, B. (2011). Risk management systems: Using data mining in developing countries' customs administrations. *World Customs Journal*, 5(1), 17–28.

- Liu, F., Ting, K., & Zhou, Z. (2012). Isolation-based anomaly detection. *ACM Transactions on Knowledge Discovery from Data*, 6(1), 1–39.
- Mahanta, J. (2017). Introduction to neural networks, advantages and applications. *Towards Data Science*. <https://towardsdatascience.com/introduction-to-neural-networks-advantages-and-applications-96851bd1a207>
- Okazaki, Y. (2017). Implications of big data for Customs – How it can support risk management capabilities. *Worlds Customs Organization*. WCO Research Paper No. 39.
- Perry, T. (2019). Reducing proliferation risk through export control outreach: Assistance providers' use of maturity model-based approaches. *Strategic Trade Review*, 5(7), 5–25.
- Singh, K., & Upadhyaya, S. (2012). Outlier detection: Applications and techniques. *International Journal of Computer Science Issues*, 9(1), no. 3, 307–323.
- US Department of Commerce and Bureau of Industry and Security. (2018). *Statistical analysis of US trade with the world*. <https://www.bis.doc.gov/index.php/country-papers/2439-2018-statistical-analysis-of-u-s-trade-with-the-world-pdf/file>
- World Customs Organization (WCO). (2019). *Strategic trade control enforcement: Implementation guide*. [http://www.wcoomd.org/en/topics/enforcement-and-compliance/instruments-and-tools/~/\\_media/7A05799E8D3A46C8B8355175EEBA4322.ashx](http://www.wcoomd.org/en/topics/enforcement-and-compliance/instruments-and-tools/~/_media/7A05799E8D3A46C8B8355175EEBA4322.ashx)
- Zhou, X. (2019). Data mining in customs risk detection with cost-sensitive classification. *World Customs Journal*, 13(2), 115–130.

## Notes

- Commodities not subject to export licensing requirements are those commodities that do not meet the technical parameter thresholds that would typically require an export license under international export control agreements, such as the Wassenaar Agreement, Nuclear Suppliers Group, Australia Group, and others. For the purpose of this research, strategic goods or those subject to export control requirements do not include those subject to national-level controls or sanctions that are applied solely on the basis of destination or export controls for other reasons than the technical specifications of the commodity in question.

### Christopher Nelson



Christopher Nelson is a senior data analyst at the New York State Office of the Attorney General. He previously served as a safeguards information analyst for nuclear trade at the International Atomic Energy Agency and a trade and industry analyst at the US Department of Commerce, Bureau of Industry and Security. He holds a Bachelor's degree in International Studies and Mathematics from American University and a Master's degree in War Studies from King's College London.





# The changing role of Customs: Customs aligning with supply chain and information management

*Frank Heijmann, Yao-Hua Tan, Boriana Rukanova and Albert Veenstra*

## Abstract

---

The World Customs Organization (WCO) Framework of Standards to Secure and Facilitate Global Trade (SAFE) introduced concepts of supply chain supervision and authorised operator schemes. While it has been implemented in many countries, supply chain supervision still requires further exploration and development. In this article we present a vision on how the role of Customs could change in the coming years, taking into account innovations in supply chain management and information technology. We present how the Customs Administration of The Netherlands adapts their supervision, based on these innovations. The innovations range from the data pipeline to collect extra data to cross-validate customs declarations, the use of big data and data analytics, new advances in detection technology, handheld apps to check goods and drones to support surveillance.

---

## 1. Introduction

The WCO adopted, more than a decade ago, the Framework of Standards to Secure and Facilitate Global Trade (SAFE), which introduced the concepts of supply chain supervision and authorised operator schemes as a response to demands for increased security (WCO, 2018). Whereas the latter has been implemented in many countries, known as AEO (Authorized Economic Operator), C-TPAT (Customs Trade Partnership Against Terrorism) or Certified Enterprise, supply chain supervision still requires further exploration and development. However, since the introduction of SAFE we have witnessed additional obligations to provide data at entry and exit being placed on several supply chain stakeholders that do not have a business interest to hold these data nor—in a commercial sense—being held responsible for these. When we want to further innovate supply chain supervision, we need to respect roles and responsibilities of different stakeholders in the supply chain. This implies that, when it comes to information on the content of the consignment, contracts, price, Incoterms, quality and product, we should move upstream to the shipper, the one who packed the box, or to the buyer, as only they know exactly what is ordered. Innovation of supply chain supervision requires respecting interests, roles and responsibilities of stakeholders in business, placing burdens on the right parties, simplifying procedures and reducing red tape—in particular within the logistic chain—by re-using data from the source (Baida et al., 2008; Hesketh, 2010; Klievink et al.; Tan et al., 2011).

Information on quality, quantity, Incoterms and prices must be requested from the buyer, or the supplier where there is no buyer at importation. Demands on physical security and the integrity of movements should be put on the logistic stakeholders in the supply chain. More customs training and academic education of supply chain management, IT, business compliance, as well as legislation and enforcement (as already addressed in the European Union Competency Framework for Customs professionals in the public and the private sector), are key investment requirements to initiate and enhance further

innovation in supply chain supervision (see European Union, n.d.). The WCO upholds the PICARD standards, mainly focusing on management skills for customs executives (see WCO, n.d.). As such, today’s knowledge requirements move much further than internal customs management, enforcement and legislation. Updating the PICARD standards, which were once leaders in global customs knowledge development, to today’s requirements in skills and expertise, is urgently needed to enhance supply chain supervision. By taking the lead in this initiative the WCO will maintain its leading role in safeguarding the global supply chain.

In this article we will present a vision on how the role of customs could change in the coming years. We present a compilation and adaptation of the vision and ideas that were published earlier in white papers by the Customs Administration of The Netherlands (Customs Netherlands, 2017; 2020) based on innovations and a sequence of research projects that Dutch Customs are involved in. We would like to share these insights with the WCO community.

## 2. How the role of Customs could change

Customs is responsible for the enforcement of the fiscal integrity, security and safety of cross-border movements of goods. At the same time, Customs is expected to contribute to the economic competitiveness of the country by providing support and furthering the implementation of measures that promote trade. As a result, Customs fulfils a dual role: it both inspects and stops goods and allows goods to pass through without unnecessary interruptions. Customs intends to continue to fulfil this demanding task in an efficient and effective manner in the future.

### 2.1 Pushing boundaries

For this reason, some years ago Dutch Customs—under its ‘Pushing Boundaries’ motto—developed a new vision that will serve as a benchmark for reviews of all the measures to be implemented in the coming years and marks the final destination Customs will aim for. This vision is not a blueprint, but rather a compass that will enable Customs to take the right steps to reach its ultimate objective. A preliminary study identified that the approach of Customs, as prescribed in the Pushing Boundaries vision, could help trade to reduce their customs-related costs by 137 million US dollars per year in the Netherlands (ACTAL, 2013).

Figure 1: Pushing boundaries: the Customs Administration of The Netherlands’ vision for the enforcement on continuously increasing flows of goods<sup>1</sup>

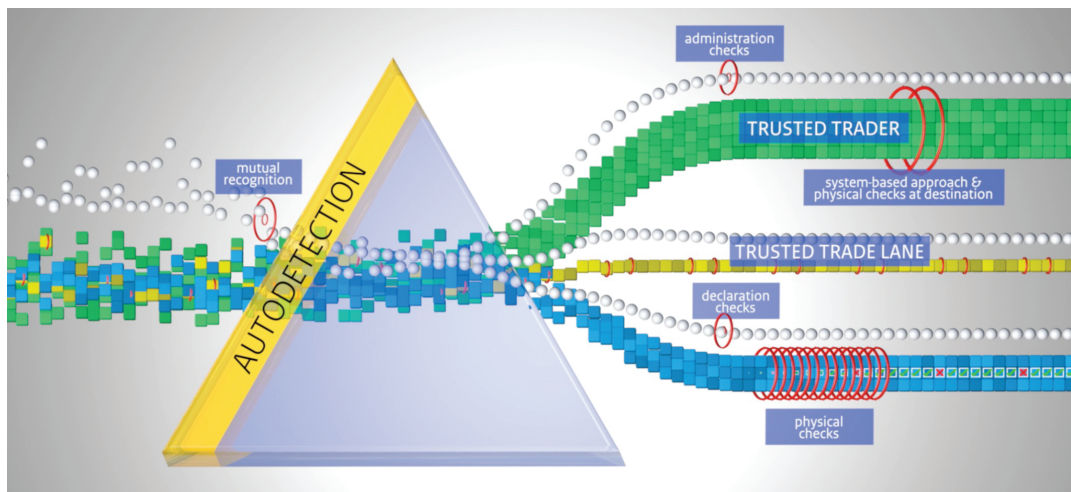

Since the introduction of the Pushing Boundaries vision, international trade flows continuously grew. This is not only applicable to goods imported or exported by sea but is equally applicable to other modalities. Above all, e-commerce has changed the landscape substantially. However, at the same time Dutch Customs' traditional enforcement capacity is expected to remain unchanged or even decrease. As a result, Customs needs to refine its enforcement process. For this reason, Dutch Customs has developed its enforcement vision—a concept of the most sophisticated manner in which the organisation can supervise large volumes of cross-border flows of goods in the near future. In essence, pursuant to this vision, Customs supervises 100 per cent of the goods that cross its EU-external borders. However, this does not imply that Customs opens each and every box or container, but that Customs can determine whether the required notification and declaration has been filed for every transport entering or exiting the country. It also implies that the information in the declarations and other sources provide Customs with a thorough insight into every container and pallet entering or exiting the country. In this ideal situation, Customs will be able to conduct more targeted physical and administrative inspections than is currently the case. It is aimed to increase the effectiveness of enforcement interventions. These inspections are preceded by the collection and weighing of information, and by risk detection and selection. To achieve these objectives, innovations have been conducted in five innovation areas: auto-detection of goods, auto-detection of data, and the differentiation of three flow types of goods; green, yellow and blue, each receiving different enforcement actions (see also Figure 1).

## 2.2 Automated detection

Customs will need to continue to invest in innovative technology and ICT to be able to implement this philosophy. A variety of modern technological aids have already increased the effectiveness and efficiency of Customs' supervision. These include, to achieve 100 per cent supervision, what are referred to as the aviation and maritime 'virtual networks': radar images made available via the Coastguard and Ministry of Defence provide Customs with an insight into the vessels and aircraft in territorial waters and airspace. Nuclear detection gates are the first enforcement layer, with 100 per cent of all cargo moving through ports being detected on radiation. These gates are located at logical points along the customary routes: drivers do not need to make detours or stop as the equipment automatically detects whether goods emit radiation. Customs does not need to intervene unless variances are detected. In other words, this system constitutes a form of 100 per cent inspection that, in principle, causes the business community no interruption whatsoever.

A next step in the auto-detection is the introduction of algorithms in non-intrusive scanning equipment. The scanned images currently need to be analysed by an officer, but with research and developments as set out, in the future they will be examined by automated scan interpretation software. Software will then compare the scans with reference files that include all the information about the relevant goods known to Customs, such as information from the declarations. Variances detected between the information on the documents and the contents of the container will result in the generation of a signal. Customs will use this intelligence to take appropriate action.

A second development track of which Customs has great expectations in the long term is the co-creation of scanning equipment that not only makes images but also assesses them for irregularities. These are artificial intelligence systems that signal that there is a mismatch, for example, between the data entered in the declaration and the goods present. Or that there are items in a container, suitcase or postal package that are prohibited or subject to a licence. In the meantime, predictive models for goods scans are being developed, based on data analytics algorithms. But that is no easy task. In order to design predictive models, data analysts must be able to rely on an archive (database) with a large number of scan images. For example, automated recognition of a weapon requires hundreds of images from all angles of this weapon. To process the goods scans automatically, it is necessary that all sensor data—in this case the x-ray images—is collected and processed in one central database, together with the declaration data and historical inspection data. The results of this automated processing must then be taken back to the scan.

In the past, there was no need for this infrastructure to store, collect and process sensor data. Customs is now faced with the challenge of building this infrastructure with a minimum of delay. The first thing to do now is to store and label scan images on a large scale for reuse and analysis. To place what scanned images can reveal in the right context, it is important to label each type of object with the utmost care. There can be no reliable algorithm without thorough data preparation! It goes without saying that this data preparation is a time-consuming and labour-intensive process. The process of storing, labelling, reusing and analysing scan images also involves formal legal aspects. Take the overriding importance of information security, for example. In short, what are the preconditions for using and sharing data to enable the auto-detection of scanned images? And how do we ensure that we put these conditions into practice in the right way? These issues are relatively new to Customs and take time. For Customs, the development of auto-detection of data and goods calls for investment in time and effort. But the first steps in this promising direction have been taken.

To rapidly develop this X-ray scanning and detection technology, Dutch Customs is taking part in various international research projects in which new technologies in this field are being tested. An example is the European Commission – funded research project C-BORD (Effective Container Inspection at Border Control Points) in which customs services, knowledge institutes, universities and industrial partners are working on the development of ultramodern scanning and sensor techniques, which are used for integrated inspection purposes in a single passage for trucks (C-BORD, n.d). Special attention is paid to the detection of narcotics and nuclear goods in freight containers. How does C-BORD work? As soon as a truck passes through the gate, it is subjected to a range of inspection technologies. A component or a combination of components of the inspection line is activated for each type of goods and for each type of risk selection. Gas phase measurement is carried out, for example, by means of sensors (i.e. an analysis of air from the container). This is followed by passive radiation detection. Traditional X-ray scanning technology is also part of the C-BORD arsenal, but in its most advanced form. These steps may give rise to further checks, such as when a significant radiation value is detected. The second-line photo-fission measurement offers a solution; this is a new method in which an X-ray beam is briefly aimed at a single position, after which secondary radiation is released and captured. This can be used to identify heavy metals, such as uranium or plutonium. The recently developed neutron scan is also being operated in the second line. This instrument is specifically aimed at identifying organic substances, especially narcotic drugs and drug precursors.

These examples make clear that, although Customs continues to adopt a risk-oriented approach, the organisation is also in part shifting towards 100 per cent inspections based on state-of-the-art technology. Elements of this approach are already both feasible and operational at the main ports such as the port of Rotterdam and Schiphol Airport. This approach is even more effective when improved detection technologies for the physical movement of goods is supplemented by the associated declarations for the goods.

### **2.3 Intelligence: collecting, weighing, validating, selecting, detecting**

Customs automated declaration processing systems are already capable of screening many elements of declarations and accepting the declarations by the use of business rules. When this screening reveals, for example, that an inward processing declaration is lodged while the declarant does not hold the required licence, the declaration will not be accepted. The same goes for an illogical combination of country codes and certificate data. Customs systems also identify declarations that contain illogical information, such as an unlikely customs value. In the longer term, Customs will incorporate more of these automated inspections in its declaration acceptance procedure. On the control elements that are checked by business rules, Customs conducts 100 per cent controls.

Specific declarations are selected for further inspections for other risks. These selections are based on intelligence: Customs collects information from various sources, refines the information, based on its

knowledge of goods and risks, and then draws up selection profiles. The information in declarations filed with Customs is reviewed against these profiles. As a result, specific declarations may be flagged for an inspection. The number of sources of and types of information used in these processes are being expanded continually. Customs will shortly, for example, be able to detect, online, when a business was established, the itinerary of a container from origin to destination and the business's regular goods flow. In other words, Customs will have much more information available prior to the inspection of consignments. Part of the detection process will then be based on automated systems that select risks. In the longer term, declarations will be inspected by specialists who perform their duties on the basis of workflow management systems.

## 2.4 Green, yellow and blue flows

Although an increasing number of risks can be detected by these autodetection mechanisms, still risks remain that require the 'traditional' interventions. But there the other innovation areas of the enforcement vision Pushing Boundaries appear. Imagine the total flow of goods as one big haystack, and customs searching for the needle. But knowledge of the integrity of traders and supply chain offers the possibility to differentiate trade flows. A supply chain for which the data and movement are known and secured does not need to be checked in the same way as a shipment from an unknown trader. And trusted traders, like AEOs, deserve different treatment due to the level of compliance they have built into their businesses. Therefore we split the haystack into three: the **yellow flow**, smart and secure trade lanes, in which controls are mainly done at loading; the **green flow**, trusted traders, mainly checked by system-based controls in the companies' records; and the **blue flow**, which is treated with the more traditional enforcement instruments and has many more physical inspections.

## 2.5 The yellow flow: data pipeline for enabling smart and secure trade lanes

When the green and the yellow flow traders make available additional data about shipments, stakeholders and transactions, Customs can better assess the risks in the flow of goods. The better the assessment, the less the risk of unnecessary physical interventions through inspections, so data sharing is a win-win for all.

Dutch Customs has been making great efforts to promote these developments for some years. For example, Customs participates in European Commission – funded research projects such as the ITAIDE, INTEGRITY, CASANDRA and CORE, which are exploring options for the implementation of a sophisticated form of supervision of the entire chain (Baida et al., 2008; Grainger et al., 2018; Hesketh, 2010; Hulstijn et al., 2016; Jensen et al., 2017; Klievink et al., 2012; Ravulakollu et al., 2018; Rukanova, Hennignsson et al., 2018a; Rukanova, Zinner et al., 2018b; Rukanova et al., 2019; Rukanova et al., 2017; Segers et al., 2019; Tan et al., 2011; Tan et al., 2019; van Engelenburg et al., 2017; CORE Project, n.d.).

The key concepts developed in these projects are the Data Pipeline and the Customs Real-time Information System (CRIS), a monitor with all the relevant goods information from each player in a trade lane. The data pipeline is a kind of internet for logistics that is brought about by connecting the enterprise IT systems of all parties in a supply chain, and which gives Customs access to data from the source such as purchase order, invoice or container packing list to cross-validate the accuracy of declarations.

CRIS is an interface of the data pipeline where businesses make this information available on a voluntary basis.<sup>2</sup> This dashboard is developed by Dutch Customs, and it includes technology that ensures that the information accessed via a data pipeline from different business systems is available in a uniform manner. When Customs can consult this information via CRIS as and when it wishes—and possibly, even analyse the information with its risk selection tools—then it will need to request much less supplementary information from the relevant businesses manually.

## 2.6 Benefits offered by advance declarations

Another, general feature to reduce logistic burdens is the option to lodge declarations earlier than at arrival of the goods. As a result, the system can assess whether all technical acceptance requirements have been met at an early stage. Consequently, the control begins once the goods are on their way to the country of destination. Customs can carry out a risk analysis of the data, if required, or request the underlying documents for their verification—all before the arrival of the goods (e.g. Rukanova et al., 2017). This approach can avoid delays during the physical movement of the goods. For trusted traders, Customs could even communicate ahead of time that shipments at arrival will be inspected physically, which increases predictability of the supply chain substantially.

## 2.7 Coordinated border management

The success of the differentiated approach in supervision of goods depends on the willingness of colleague enforcement authorities, such as for example the product and food safety agencies, to keep pace with Customs' vision and operational approach, as this is necessary if the business community is to gain the potential benefits. Dutch Customs has already implemented a government single window for incoming and outgoing maritime and air traffic—a facility whereby businesses submit information once and the various border enforcement authorities send one reply message and re-use the information as required. In addition, it will be possible to complete the one-stop-shop and joint inspection principles: all supervision authorities carry out their inspections at the same logical place in the transport chain and the same logical moment. This will enable government agencies to jointly work towards coordinated border management. In the research project CORE, Dutch Customs developed a coordinated border management approach jointly with the Dutch National Plant Protection authority to share electronic phytosanitary certificates of flowers from Kenya, which can lead to faster import clearance and significant reduction of logistic delays after arrival of the flowers at Schiphol airport (Rukanova et al., 2017). In particular, the implementation of this coordinated digitisation at both ends of the supply chain, in Rotterdam as well as in Kenya, made this project unique.

## 2.8 Data analytics

Data analytics scientists at Customs Netherlands are involved in the design of data analytics algorithms for accessing, structuring and analysing large amounts of data. With the aid of these smart technologies it will eventually become possible to automatically detect irregularities and fraud patterns in declaration and other data and scanned images and to develop predictive algorithm software. Customs is currently working on a project concerning risk filters. The aim of these filters is to reduce the relatively high number of false positives in the traditional risk selection of Customs. Based on historical data about declarations and related inspection results, a number of test filters have been built, through which what is rejected goes back in, as it were. These are test filters on the entry process and for taking samples for examination in the customs laboratory. The filtering method makes it possible to determine whether a perceived risk is real and whether it is worthwhile to check a batch of goods. This is expected to make customs supervision more efficient and effective. It is also good news for the trade as it means a reduction in unnecessary inspections and a reduction in logistic delays.

How does the filtering method work? The model assigns a risk score to each selection produced by a risk profile. If the risk score is higher than a set threshold value, a selection is checked; if it is lower, no check is carried out. So, the higher the threshold setting, the fewer checks there will be; but also, the higher the number of missed non-compliant declarations. However, research by the data analytics experts shows that it should be possible to reduce the inspection selections in the entry process by a maximum of 30 per cent without this leading to non-compliant declarations being missed.

Another example of data analytics innovations for customs risk targeting is the website data retrieval tool that is being developed in the European Commission – funded research project PROFILE (PROFILE, 2018) in which Dutch Customs actively participates. This website data retrieval tool for the postal and courier process can be used to collect additional data from external sources, such as e-commerce websites, to cross-validate the accuracy of goods descriptions of customs declarations. The first check is for the price of a product. If the value of a given goods description found in the declaration differs significantly from the average value found on the internet, this could be a reason to physically check the shipment. The long-term aim is to automate this cross-validation process (see e.g. Rukanova et al., 2019). Another objective is to create more precise risk indicators and risk profiles by means of data mining in historical datasets. In particular, algorithms are developed that can identify risks with increasing accuracy based on historical declaration data, profiles and inspection results.

In another research project, Dutch Customs developed a mobile app that can help to identify prohibited Chinese medicines being transported in passenger luggage.

## **2.9 Camera surveillance and drone technology**

In the context of Pushing Boundaries, good progress has been made in the supervision of the blue flow in recent years. Important innovations have already been covered in the previous sections: the installation of onsite scan systems at all container terminals and the State Inspection terminal in the Port of Rotterdam and the Joint Inspection Center at Schiphol. An area still under development is airborne inspection. Using drones will make it possible in the future to observe port areas, vehicles and vessels. In 2018 the Port of Rotterdam carried out experiments with unmanned aircraft as a potential tool for customs supervision. In this pilot, Customs joined the Coast Guard, which has been conducting experiments into the added value of drone technology for the maritime domain for some time now. For Customs, for example, there were tests to establish whether airborne objects could be selected for inspection using cameras, whether the surroundings of these objects could be closely monitored, and whether any risks could be identified more quickly in this way. Customs will also investigate whether drones can contribute to the monitoring of locations around ships with a high risk. This aerial inspection should be seen as complementary to the existing surveillance using video networks of fixed CCTV surveillance cameras.

In the future, Customs also plans to experiment with mini drones. These drones will not operate in the open air, but only in enclosed spaces—especially onboard vessels. This concerns small locations that are difficult for tracking dogs and officers of the national inspection team to pass through. There are also places where there is a danger to people and animals, such as fuel tanks where toxic gases are present; these are, of course, ideal hotspots for concealed contraband.

## **2.10 Blockchain technology**

Blockchains are distributed databases that together form a network. Blockchains make it possible for parties to securely share data and execute transactions and to reach consensus agreement on the existence, status and changes of this shared information (Zheng et al., 2017). Using blockchain technology means that all the databases in a network register the blocks of information that are associated with the transfer of value or exchange of messages and data between the parties in the network. Software links these blocks to each other to create a digital general ledger in which the assets, debts or properties of all the participants in the network are stored. The information stored in the digital ledger is irrefutable and cannot be manipulated. It is also possible to program so-called smart contracts in blockchains; for example, conditions for a value transaction in advance, such as a check on a minimum balance, the availability of the right authorisations, or trigger a payment from buyer to seller. The network can then verify a number of aspects, such as the authorisation of the parties concerned. Only when all the conditions have been met is the transaction automatically completed. Examples of such conditions are

the issuance of a bank guarantee for the start of a customs duty exemption of transit procedure, or receipt of a bill of lading by the bank that activates an automated payment to the seller according to a letter of credit arrangement.

The technology that makes blockchains possible is based on various emerging techniques such as data exchange between distributed data bases, cryptography and consensus algorithms. Blockchain technology is already operating at a global level. One example of such a worldwide operational blockchain platform for sharing logistic and customs-relevant data is the TradeLens system developed by MAERSK and IBM, of which the initial prototype version was developed in the CORE project (TradeLens, 2020; Segers et al., 2019; Tan et al., 2019). TradeLens users experience the global platform as a messaging service. It gives the exporter a web address to which they send a contact number, which is then stored in the blockchain. Which data they receive (e.g. from the forwarder) and in what form, depends on their authorisation. Typically, TradeLens contains risk-relevant datasets that correspond to a container, such as the invoice, packing list and bill of lading related to the goods shipped in a container. Dutch Customs is developing a dashboard—CRIS—that a customs officer can use to retrieve these data via TradeLens about the containers coming to Rotterdam (i.e. all the data provided by the parties concerned in TradeLens). Using a risk filter, Customs can identify the most high-risk shipments. Based on these findings, Customs could in turn provide status information to the TradeLens platform, such as ‘container selected for inspection’ or ‘container released’. TradeLens can count on the increasing interest of the business community. More and more shipping companies, shippers, importers and exporters are now using this industry-wide platform.

### **2.11 The spot on the horizon—smart enforcement—smooth logistics**

The change of the trade landscape requires Customs to constantly adapt to the outer world’s changing demands. But also to have a permanent innovative approach. Therefore, the vision Pushing Boundaries, once developed to introduce blue, yellow and green trader flows, is changing. With increasing technological developments and changing needs in enforcement, a stronger is placed on autodetection. Regardless in what flow goods will be placed, all in- and outgoing cargo and data are scanned automatically on an increasing number of risks. And customs interventions are not merely done based on the possibility that a detected risk shows a mistake. Customs act on anomalies, differences in data detected in various sources of information, of which the customs declarations and scan images are just a few out of a wide range of data sources.

### **2.12 Multidisciplinary customs education**

The innovations described above require multidisciplinary expertise from customs officers on customs legislation and procedures, supply chain management and information technology and compliance. Customs officers need to understand how supply chains are managed to be minimally disruptive when physical inspections are still needed. And they need to understand how companies have implemented the appropriate internal controls in their IT systems to mitigate the customs risks in their business operations. This multidisciplinary expertise is taught in the Master Customs and Supply Chain Compliance<sup>3</sup> of the Rotterdam School of Management, which is based on three pillars: teaching expertise in (1) customs legislation and procedures, (2) supply chain management and (3) information technology and compliance. This master’s program is based on the principles of the Pushing Boundaries vision and was developed in close collaboration with Dutch Customs. This master’s program is internationally recognised and accredited by the European Commission in the context of the European Union Competency Framework for Customs as well as by the PICARD program of the WCO.



### 3. Conclusion

In summary, Customs needs to move more to the supply chain, the innovation area that is left partly underdeveloped compared to the other goals of the SAFE Framework of Standards. An example of the role of Customs in a supply chain approach can be found in the Dutch vision Pushing Boundaries. Although this was developed a few years ago, Customs is still working towards autodetection and its layered approach enforcement concept, with supervision in blue, green and yellow variants. Customs then:

- in the blue goods flow intervenes in the logistics at the border based on risk analyses
- in the green goods flow makes observations—preferably outside of the logistics process—to verify that traders are acting correctly
- in the yellow goods flow works on securing entire chains.

However, the success of this concept is not only dependent on Customs but is equally dependent on the business community's faith in the concept and its efforts. This is already the case with, for example, the AEO system—which is founded on economic operators' trust in the system. Trusted trade lanes, in conclusion, can operate solely when businesses identify their own (commercial) benefits for improved data sharing and granting government, like Customs, access to those data.

The WCO SAFE Framework aims to establish standards that provide supply chain security and facilitation at a global level to promote certainty and predictability; enable integrated supply chain management for all modes of transport; recognise AEOs; and promote the seamless movement of goods through secure international trade supply chains. Pushing Boundaries provides a Customs response to all of these goals. Trusted traders receive a customs treatment that serves their level of compliance; trusted trade lanes are mainly controlled upstream at the consignment completion point, and Customs-to-Customs information exchange avoids double controls. Business will be acknowledged for its compliance efforts, and Customs can focus on the real dangers. The WCO PICARD Standards that focus on knowledge development need to be updated to meet these new requirements on all levels of the customs profession in government and business.

Since the term autodetection was introduced, many new technological developments have occurred, and the term autodetection has moved into a new dimension. Whereas initially this focused on mechanisms and technology to split the flows into green, yellow and blue, the examples in this article show that autodetection is an enforcement goal in itself. Technology can assist Customs to detect risks in data, from various sources, declarations, commercial data and images. So technology takes over part of the customs analytics work. Therefore, we move towards 'Pushing Boundaries, the next step! Smart Enforcement and Smooth Logistics'.

### Acknowledgements

This research was partially funded by the PROFILE Project (nr. 786748) and PEN-CP Project (nr. 786773), which are funded by the European Union's Horizon 2020 research and innovation program. Ideas, adaptations and opinions expressed by the authors do not necessarily represent those of other project partners or of the Customs Administration of The Netherlands.

## References

- ACTAL. (2013). *Rules for businesses: sector scan Logistics* (in Dutch). ACTAL Advisory Board Assessment Regulatory Pressure, The Hague, November 2013.
- Baida, Z., Rukanova, B., Liu, J., & Tan, Y. H. (2008). Preserving control in trade procedure redesign – The beer living lab rethinking EU trade procedures. *Electronic Markets*, 18(1), 53–64.
- C-BORD. (n.d.). *Effective container inspections at border control points*. <https://www.cbord-h2020.eu/>
- CORE Project. (n.d.). <http://www.coreproject.eu/>
- Customs Netherlands. (2017). *Pushing boundaries: The Customs Administration of The Netherlands' point on the horizon for the enforcement on continuously increasing flows of goods*. White paper, Customs Administration of the Netherlands.
- Customs Netherlands. (2020). *Pushing boundaries: Future vision for customs supervision: principles, developments and results*. White paper, Customs Administration of the Netherlands.
- van Engelenburg S., Janssen M., Klievink B., & Tan Y. H. (2017). Comparing a shipping information pipeline with a thick flow and a thin flow. In M. Janssen, K. Axelsson, O. Glassey, B. Blievink, R. Krimmer, I. Lindgren, P. Parycek, H. J. Scholl, & D. Trutnev (Eds.), *Electronic Government* (pp. 228–239). *EGOV: International Conference on Electronic Government 2017*. Lecture Notes in Computer Science, vol. 10428. Springer.
- European Union. (n.d.). *CustCompEU – EU Customs Competency Framework*. [https://ec.europa.eu/taxation\\_customs/eu-training/eu-customs-competency-framework\\_en](https://ec.europa.eu/taxation_customs/eu-training/eu-customs-competency-framework_en)
- Grainger, A., Huiden, R., Rukanova, B., & Tan, Y. H. (2018). What is the cost of customs and borders across the supply chain? ... and how to mitigate the cost through better coordination and data sharing? *World Customs Journal*, 12(2), 3–30.
- Hesketh, D. (2010). Weaknesses in the supply chain: who packed the box. *World Customs Journal*, 4(2), 3–20.
- Hulstijn J., Hofman W., Zomer, G., & Tan, Y. H. (2016). Towards trusted trade-lanes. In H. J. Scholl, O. Glassey, M. Janssen, B. Klievink, I. Lindgren, P. Parycek, E. Tambouris, M. Wimmer, T. Janowski, & D. Sa Soares (Eds.), *Electronic Government* (pp. 299–311). *EGOV: International Conference on Electronic Government 2016*. Lecture Notes in Computer Science, vol. 9820. Springer.
- Jensen, T., Vatrapu, R. K., & Bjorn-Andersen, N. (2017). Avocados crossing borders: The problem of runaway objects and the solution of a shipping information pipeline for improving international trade. *Information Systems Journal*, 28(4). DOI:10.1111 / isj.12146
- Klievink, B., Van Stijn, E., Hesketh, D., Aldewereld, H., Overbeek, S., Heijmann, F., & Tan, Y. H. (2012). Enhancing visibility in international supply chains: The data pipeline concept. *International Journal of Electronic Government Research*, 8(4), 14–33.
- PROFILE. (2018). *Welcome to PROFILE-project*. <https://www.profile-project.eu/>
- Ravulakollu, A., Urciuoli, L., Rukanova, B., Tan, Y. H., & Hakvoort, R. (2018). Risk based framework for assessing resilience in a complex multi-actor supply chain domain. *Supply Chain Forum: An International Journal*, 19(4), 266–281.
- Rukanova B., Zinner Henriksen, H., Heijmann, F., Arifah Arman S. A., & Tan, Y. H. (2018). Public funding in collective innovations for public–private activities. In P. Parycek, O. Glassey, M. Janssen, H. J. Scholl, E. Tambouris, E. Kalampokis, S. Virkar (Eds.), *Electronic Government* (pp. 132–143). *EGOV: International Conference on Electronic Government 2018*. Lecture Notes in Computer Science, vol. 11020. Springer.

- Rukanova, B., Tan, Y. H., Slegt, M., Molenhuis, M., van Rijnsoever, B., Plecko, K., Caglayan, B., & Shorten, G. (2019). Value of big data analytics for customs supervision in e-Commerce. In I. Lindgren, M. Janssen, H. Lee, A. Polini, M. P. Rodriguez Bolivar, H. J. Scholl, & E. Tambouris (Eds.), *Electronic Government* (pp. 288–300). EGOV: International Conference on Electronic Government 2019. Lecture Notes in Computer Science, vol. 11685. Springer.
- Rukanova, B., Henningsson, S., Henriksen, H. Z., & Tan, Y. H. (2018a). Digital trade infrastructures: A framework for analysis. *Complex Systems Informatics and Modelling Quarterly*, 14, 1–21.
- Rukanova, B., Huiden, R., & Tan, Y. H. (2017). Coordinated border management through digital trade infrastructures and trans-national government cooperation: The FloraHolland case. In M. Janssen, K. Axelsson, O. Glassey, B. Blievink, R. Krimmer, I. Lindgren, P. Parycek, H. J. Scholl, & D. Trutnev (Eds.), *Electronic Government* (pp. 240–255). EGOV: International Conference on Electronic Government 2017. Lecture Notes in Computer Science, vol. 10428. Springer.
- Segers, L., Ubacht, J., Tan, Y.H., & Rukanova, B. (2019). The use of a blockchain-based smart import declaration to reduce the need for manual cross-validation by customs authorities. In *Proceedings of dg.o 2019: 20th Annual International Conference on Digital Government Research (dg.o 2019)*, June 18, 2019, Dubai, United Arab Emirates. ACM, New York, 196–203.
- Tan, Y. H., Bjørn-Andersen, N., Klein, S., & Rukanova, B. (2011). *Accelerating global supply chains with IT-innovation: ITAIDE tools and methods*. Springer Science & Business Media.
- Tan, Y. H., Rukanova, B. D., van Engelenburg, S. H., Ubacht, J., & Janssen, M.F.W.H.A. (2019, September 18). Developing large scale B2B blockchain architectures for global trade lane. Paper presented at the *6th Innovation in information infrastructures (III) workshop*, September 18, 2019, Surrey, United Kingdom.
- TradeLens (2020). Tradelens. <https://www.tradelens.com/platform>
- World Customs Organization (WCO). (2018). *SAFE Framework of Standards*. WCO.
- World Customs Organization (WCO). (n.d.). *PICARD programme*. [http://www.wcoomd.org/en/topics/capacity-building/activities-and-programmes/cb\\_picard\\_overview.aspx](http://www.wcoomd.org/en/topics/capacity-building/activities-and-programmes/cb_picard_overview.aspx)
- Zheng, Z., Xie, S., Dai, H., Chen, X., & Wang, H. (2017). An overview of blockchain technology: Architecture, consensus, and future trends. *Proceedings – 2017 IEEE 6th International Congress on Big Data, BigData Congress 2017, October*, 557–564. <https://doi.org/10.1109/BigDataCongress.2017.85>

## Notes

- 1 See Customs Netherlands (2017) and <https://youtu.be/iiNkKIBO99k>
- 2 Voluntary means that businesses provide information in advance to the cargo movement, that Customs can ask for once starting to control declarations.
- 3 <https://www.rsm.nl/executive-education/executive-master-customs-and-supply-chain-compliance/overview/> Yao-Hua Tan and Albert Veenstra are, respectively, program director and academic director of the program. Frank Heijmann is involved as one of the key lecturers in the program.

### Frank Heijmann



Frank Heijmann is head of trade relations of The Customs Administration of The Netherlands, holding almost 35 years of Customs experience, having an in-depth knowledge in the fields of customs legislation, international business and logistics. He is recognised for motivating people, creating enthusiasm and support. This has resulted into the collective developments of novel ideas and solutions that focus on the balance between enforcement and trade facilitation, with trade, governments and academia, as there are the University MSc program Customs & Supply Chain Compliance, the BSc Customs & Trade Compliance, the supply chain innovation concept The Pipeline Interface, and Dutch Customs' vision 'Pushing Boundaries'.

### Yao-Hua Tan



Yao-Hua Tan is full professor of Information and Communication Technology at the Delft University of Technology. He is program director of the Master program in Customs and Supply Chain Compliance at the Rotterdam School of Management. His research fields are IT innovations for data sharing, (big) data analytics for compliance management of international supply chains. He is scientific coordinator in the EU-funded projects ITAIDE, CASSANDRA, CORE, PROFILE and PEN-CP. He was vice-chair of the Committee on Trade of the Trade Division at the United Nations Economic Commission for Europe and regularly acts as an expert for various Dutch government committees and the European Commission.

### Boriana Rukanova



Boriana Rukanova is a senior researcher at Delft University of Technology. She has been working on a series of EU-funded innovation projects in the area of eCustoms and international trade such as ITAIDE (2006–2010), CORE (2014–2018), PROFILE (2018–2021) and PEN-CP (2018–2023). Her research interests include initiation and upscaling of digital trade infrastructures, business-government information sharing, and the use of big data and analytics. Her research appears in leading international journals such as Government Information Quarterly, European Journal on Information Systems, Electronic Markets, Transforming Government: People, Processes and Policies, book chapters and proceedings of international conferences.

### Albert Veenstra



Albert Veenstra is professor of Trade and Logistics at Rotterdam School of Management, and scientific director of the Dutch Institute of Advanced Logistics (DINALOG). He is also academic director of the Master of Science in Customs and Supply Chain Compliance. He has been involved in research in the field of trade compliance and border management for more than 15 years. He has published in the field and is regularly invited as a speaker or moderator. He is also involved in the development of teaching material in the area of supply chain and trade compliance.

# How can Customs better leverage emerging AI technologies for more sustainable and smarter operations?

*Ismael Kafando*

## Abstract

---

Technological innovation is happening at a faster pace than ever before, creating new opportunities as well as challenges for many industries. This research paper aims to contribute to the efforts deployed by many customs administrations to leverage artificial intelligence (AI)–driven technologies in order to support smarter operations and efficiency. It makes recommendations to identify the organisational processes that could benefit from AI and machine learning (ML)–based initiatives.

The result of this paper is a set of practical frameworks coupled with technical, organisational and policy recommendations, which form a coherent business innovation kit to assist customs administrations to successfully start or scale their digital transformation journey.<sup>1</sup>

---

## 1. Introduction

With the rapid digital transformation impacting numerous industries globally, sophisticated data-driven technologies are now becoming more accessible to business organisations. Such accessibility has created new opportunities for customs administrations to support their reforms and modernisation programs. However, the need to leverage those technologies also creates new questions such as:

- What are the existing customs business processes that can benefit the most from AI-driven technologies?
- What are the right data solution technologies customs administrations should invest in to achieve growth and success in their business?
- How can we integrate identified technologies into the existing processes and systems assets?
- Do customs administrations have the required expertise to obtain the full benefits of the considered technologies? Should they hire/consult experts or train existing resources?
- How should we roll out an effective change management process to maximise the likelihood of delivering the intended results and outcomes?

This paper makes a positive contribution to the efforts that many countries are undertaking to modernise their customs administrations.

The paper is comprised of three parts. The first part suggests a practical and simple guideline to map AI–driven technologies values with the key customs processes, challenges and desired benefits, which identifies relevant cases that could benefit from AI–based initiatives. The second part describes a framework

that enables customs administrations to design and frame new ways to pursue modernisation projects. This part emphasises the dimensions and the critical success factors for an effective implementation of new technologies in the context of customs administrations. Finally, the third part highlights the technical considerations and requirements and makes organisational and policy recommendations to ensure a successful implementation of AI technologies.

## 2. Methodology

In order to answer the above questions, comprehensive desk research was undertaken to review relevant works, studies and documents and to perform an in-depth assessment of ‘international best-practice’ surrounding the customs systems modernisation initiatives. The research also considered global innovation concepts and the experience of the author in implementing risk management systems for the use of Customs and trade, to propose practical guidelines for assessing needs and analysing, acquiring and integrating market emerging technologies to support customs operations.

The purpose of the paper is to propose simple and concrete frameworks—inspired from various business innovation concepts—that can assist customs administrations to effectively incorporate new technologies and achieve enhanced sustainability.

In this document,

- ‘new technology’ refers mainly to data solutions that embed AI capabilities
- ‘sustainability’ (or ‘sustainable’ business) is an approach to creating long-term value by taking into consideration how organisations such as customs administrations can thrive and grow their business while simultaneously solving some of the trade participants’ biggest challenges.

## 3. Mapping AI technologies

Customs administrations create more data every day and aim to use this data to enhance efficiency in their processes. From pre-arrival information screening to clearance and post-clearance regulatory activities handling, incorporating AI-powered technologies can assist Customs to make sense of data, drive insights, automate accurate decision-making and generate a positive business impact.

In this section, different business innovation models (Osterwalder et al., 2014; Bocken et al., 2013; Martins et al., 2017) and customs literature are used to describe how to identify opportunities to create and capture value in the customs environment using AI technologies.

### 3.1 Defining the right business-use cases

A use case is a list of actions or steps typically defining the interactions between a role (a human or another system) and a system to achieve a goal or create a value for a stakeholder or group of stakeholders.

To define the right use cases that can be supported by AI projects and achieve meaningful and sustainable improvement of customs performance, a holistic view and analysis of the value creation chain for all stakeholders is required. This involves understanding the tangible and intangible value flows between stakeholders and identifying relationships, interactions, and opportunities for greater collaborative value creation that is mutually beneficial (Bocken et al., 2013). The business-use case definition process is shown in Figure 1.

Figure 1: Business-use case definition process



### Identifying stakeholders and intended beneficiaries

The starting point of defining the right use cases is to identify the stakeholders in the trade ecosystem that might be impacted by the introduction of an AI initiative. Common examples of stakeholders' networks may include:

- internal audience (such as main organisational functions and officers)
- supervisory ministry (on behalf of the government)
- direct customers (mainly importers and clearing agents)
- other trade participants (exporters, suppliers, shippers and other logistics providers)
- other government agencies (such as other cross-border regulatory authorities)
- key international organisations (such as World Customs Organization (WCO), World Trade Organization (WTO), regional development banks)
- the community (consumers and society).

The next step is to identify sub-groups of stakeholders (the main beneficiaries) who are in need of, or likely to benefit most from the AI project(s) and understand their profiles. They are directly connected to the project's ultimate success or failure (Hsiao & Tran-Thien, 2020). For example, if the envisaged technology solutions aim to support a secure, trusted and facilitated trade environment, the most important and direct beneficiaries might be Customs internal job functions, the local traders (importers and clearing agents) and society.

### Understanding the beneficiaries' profiles to generate relevant ideas (use cases)

With the target beneficiaries identified, it is then important to consider exactly how AI applications or technologies will improve their experience. As with any modernisation initiative, the introduction of an AI technology-based project 'shall be carried out in consultation with all relevant parties directly affected,

to the greatest extent possible' (Revised Kyoto Convention, RKC – Chapter 7). This will assist in gaining an understanding of the direct beneficiaries, their needs, their current processes and their habits.

Preliminary desk research should be undertaken to review relevant documents such as reports, procedures, existing studies, documented best-practice, blueprints and roadmaps to gather the first use case ideas. The next step will be to conduct ideation workshops in small groups with the key stakeholders (internal and external). Selecting the right people and involving them effectively are determinants for the success of the ideation sessions and there are important factors to consider for their selection:

- Participants should be familiar with the topic of the session to maximise their level of contribution. It is important to give them time to prepare for the session.
- Their areas of expertise and their goals should be linked with the topic(s) of the session. Participants who have a deep understanding of the challenges in question will be better equipped to find successful use cases.
- There should be cognitive and functional diversity among the participants (e.g. different business lines, different experiences) to allow for different ideas to flourish and to generate out-of-box perspectives.
- Decision-makers should be involved to ensure successful outcomes.

The ideation workshops should begin with a briefing session to share the vision of the initiative in values-based terms, to introduce key notions and tools that will be used and present practical use case examples.

There are many tools that can be used during workshops to define the customers' profiles and generate relevant use cases. A good example of such tools is the value proposition canvas (VPC) designed by Osterwalder et al. (2014), which helps managers and business analysts identify the customers' major activities (jobs-to-be-done), the performance bottlenecks (pains) they face when trying to accomplish those jobs and the value (gains) they perceive by getting the job done (see Figure 2). Workshops can also incorporate aspects of 'design thinking'<sup>2</sup> to encourage ideation.

*Figure 2: Customer profile map*

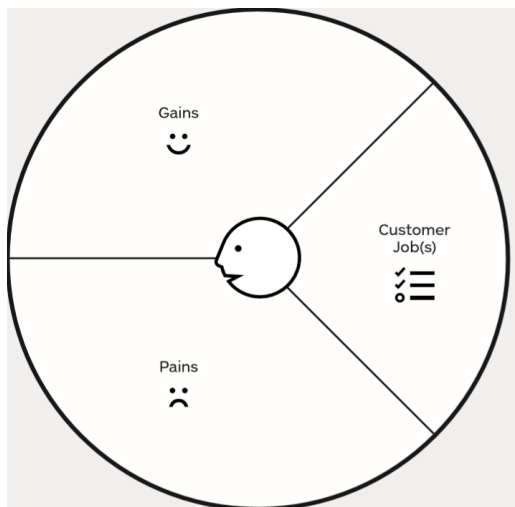

Source: Osterwalder et al. (2014)



The following example ‘Box 1’ illustrates how VPC can be applied to describe a specific group of job functions in Customs. As conditions differ significantly across countries, the selected items in the example may not be fully relevant to all customs administrations.

**Box 1: Personas: Law enforcement & trade facilitation jobs functions**

**Key activities/Jobs to be done**

Ensure and monitor collection of all customs duties and taxes that are due

- Protect national borders from illegal entry and exit of prohibited goods
- Protect citizens against threats (such as contaminated food, unsafe goods, fake medicines and other counterfeit products)
- Ensure relevant information is available, up-to-date and easily accessible to the trade community
- Provide effective and quality services to individuals, commerce and industries, importers and exporters
- Facilitate legitimate trade and promote voluntary compliance

**Pain points & barriers**

- Sophistication of fraud (tax evasion and avoidance, smuggling of drugs, dangerous, harmful and prohibited goods, money laundering, and trade in counterfeit goods)
- Increasing demand for rapid movement of goods and calls for shifting from physical to more audit-based controls undertaken away from the border posts
- Limited resources and skills to perform customs functions efficiently and effectively
- Insufficient customer-oriented service culture to interface with traders and build new partnerships
- Trade undertaken by the informal sector and in second-hand goods are substantial and the reliability of their commercial invoices tends to be poor
- Ongoing risk of corruption given the nature of the jobs performed by customs staff

**Gains/perceived value**

- More disciplined and structured approach to managing risk and customs operations
- Customs staff well-trained and empowered with tools and methods to deliver quality service to traders and to tackle illicit trade more effectively
- Trusted agency for state revenue generation and for national safety protection
- Built-in accountability mechanisms reduce both the opportunity and incentive for corruption
- Stimulated voluntary compliance
- Promotion of foreign direct investments (FDI)

From this example, several use cases can be generated. The relevant ones should outline, from the users’ point of view, the important capabilities that can be supported by systems to relieve the identified pains (barriers) and/or realise the gains (or value). The right use cases should address the current and future challenges faced by customs administrations.

These ideation sessions in small groups are an iterative process that should be performed for each of the selected beneficiaries to define ultra-targeted value proposition content and generate exhaustive use cases.

**Assessing and prioritising the relevant use cases**

The best way to assess and prioritise use cases is to test their desirability across the intended beneficiaries. This can be achieved by mapping for instance the beneficiaries’ profiles and motives in a manner to identify the use cases that enable shared value creation for all stakeholders. A simplified version of a value mapping tool<sup>3</sup> is an example of available instruments that can be used by customs organisations to consider this multiple-stakeholder value perspective when prioritising use cases. This tool was developed to assist in sustainable business modelling and aims to assist in:

- Identifying conflicting use cases that create a positive value proposition for one stakeholder and a negative one for another stakeholder. It is important to avoid or redefine conflicting use cases to avoid resistance during the project implementation stage and its ultimate failure.
- Emphasising opportunities for use cases redefinition and alignment in order to reduce negative outcomes and improve the overall value for the stakeholders’ network.

Figure 3 shows an adapted version of the value mapping tool that can be used by Customs to prioritise business use cases.

*Figure 3: Simplified value mapping tool for Customs*

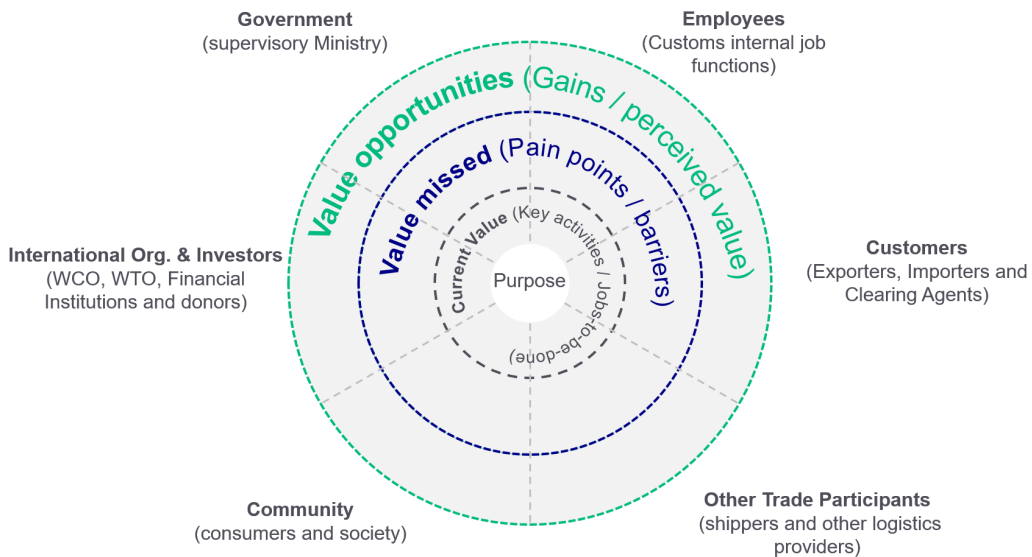

Source: Adapted from Bocken, Rana and Short (2015)

The alignment activity allows for the identification of the desirable use cases that answer important needs and offer greater alignment between key stakeholders’ interests. Desirable use cases maximise the chances of getting stakeholders on board during the implementation step.

The desirable use cases also need to be feasible. The next step is therefore to assess the feasibility from a technical, financial and practical perspective. Dimensions such as data availability, knowledge requirements, legal feasibility and stakeholders’ acceptability must be considered. Retained use cases should be realistic and should consider the country’s capacity to implement, the time and investment that are required, and the level of stakeholder and political support that is needed. It is important to provide a basic assessment grid, elicit uncertainties and assumptions when discussing the results with the whole group in order to avoid subjectivity on the prioritisation. Figure 4 shows a simplified use cases prioritisation scheme.

Figure 4: Simplified use cases prioritisation scheme

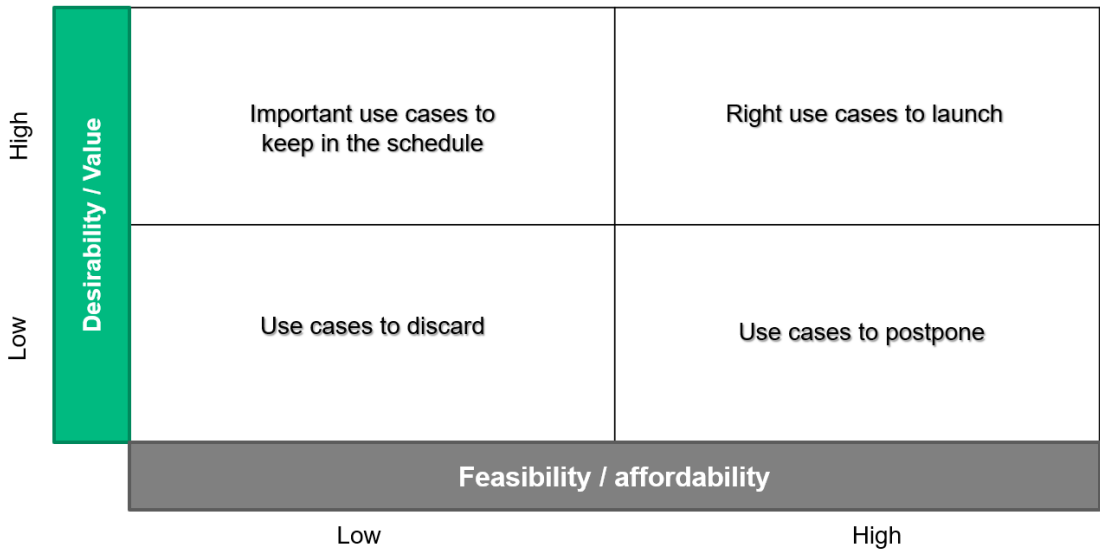

#### 4. Selecting the right AI technologies

With the targeted beneficiaries identified and the right use cases selected, it is then important to support them with the appropriate technology solutions.

Generally, emerging technologies incorporation can help customs administrations in the following areas:

- Improved effectiveness in executing internal core processes: increased revenue collection, speed, better non-compliance risk mitigation, improved team accuracy and efficiency, and decreased costs.
- Automation of routine and time-consuming tasks: increased speed and efficiency, reduced manually introduced errors, less repetitive work and improved employee satisfaction.
- State-of-the-art governance: real-time operational and team efficiency monitoring, enabled trust and transparency over customs operations, and performance appraisals driven by data.
- Image and competitive-edge enhancement: online and easy access to relevant information, delivery of beneficial digital services to trade, impartial and transparent risk management – driven controls, use of modern channels (such as mobile platforms and social medias) to interact with Customs, report concerns and provide feedback, and strong engagement of the trading community.
- New revenue streams development thanks to the commercialisation of some digital services that the trade will be willing to pay for.

Table 1 outlines examples of disruptive technologies that can be customised and adopted by customs administrations to change their work conditions, and the relation they have with traders.

Table 1: Disruptive technologies

Technology	Examples of technology applications
<b>AI – machine learning</b>	<ul style="list-style-type: none"> <li>• AI-based risk management</li> <li>• PCA and assisted case management</li> <li>• Automated container images processing and objects recognition</li> <li>• Cargo tracking geodata analytics</li> <li>• Advanced predictive business intelligence (BI)</li> </ul>
<b>AI – natural language processing (NLP)</b>	<ul style="list-style-type: none"> <li>• Automated classification of products</li> <li>• Optical character recognition (OCR) and data storage</li> <li>• Advanced BI with text mining and NLP capabilities</li> <li>• E-Customs platform with imbedded chatbots that provide 24/7 customer service</li> </ul>
<b>AI – robotics</b>	<ul style="list-style-type: none"> <li>• Repetitive tasks automation and human-like cognitive abilities</li> <li>• Data robot – powered recommendation engine that produces dynamic suggestions</li> <li>• Computer vision and automated object counting for visual inspection</li> <li>• Virtual workforce to automate routine business processes</li> </ul>
<b>Blockchain</b>	<ul style="list-style-type: none"> <li>• Trade traceability and end-to-end visibility</li> <li>• Smart contracts</li> <li>• Blockchain-based e-commerce</li> <li>• Container track &amp; trace</li> <li>• Electronic certification/authentication of LPCO</li> <li>• Identity management (unique personal identity, tax identification number)</li> </ul>
<b>Internet of things (IOT)</b>	<ul style="list-style-type: none"> <li>• Cargo-tracking devices (such as RFID, GPS sensors, etc.)</li> <li>• Geo-fencing technology to secure containers</li> <li>• Smart port logistics processes (connected devices for logistics, traffic management)</li> <li>• Other automatic identification systems linked to GPS.</li> </ul>

Before determining the required technology in which to invest, it is important to ensure that it is not only a good fit for the business needs, but also the implications, risks and rewards are understood. The introduction of innovative technologies within Customs needs to be managed from both technical and human perspectives—not only from an internal Customs perspective but also from the external stakeholders’ viewpoint.

## 5. Adopting AI technologies

Technology adoption refers to the successful selection and integration of new technologies in Customs business and its spread to a general use and application so that greatest impact and most benefits are realised for Customs, the local business community and society.

## 5.1 Framework for emerging technologies adoption

The following section defines conceptual frameworks, inspired from business model innovation concepts, that emphasise the key components influencing the successful incorporation of AI-based technology in the customs environment. The first framework (Figure 5) identifies conceptual interconnected blocks that show at macro level the process from value proposition to value capture that should guide emerging technologies adoption initiatives.

Figure 5: Conceptual interconnected blocks for value creation and value capture

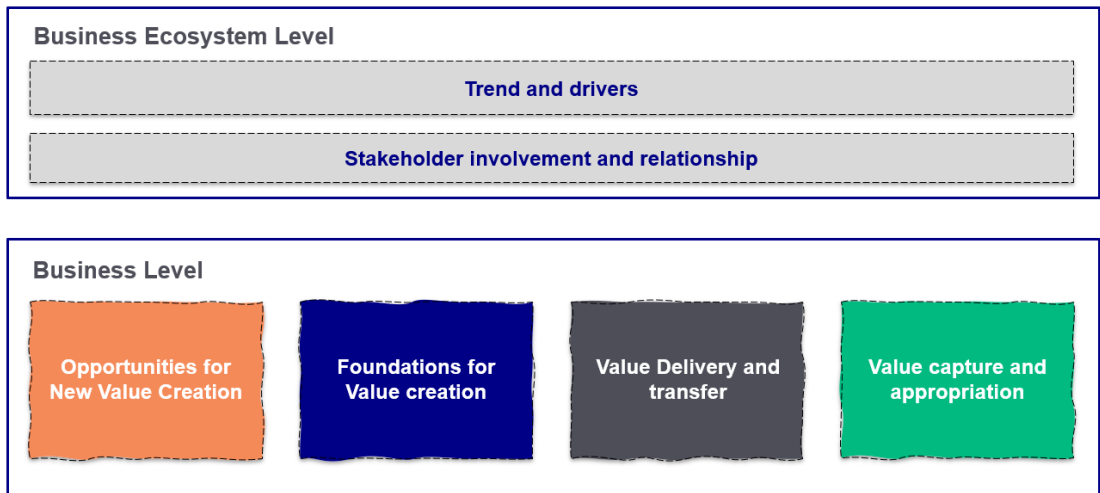

Source: Adapted from Bocken, Rana and Short (2015)

At the **business ecosystem level**, the analysis of the business environment and scanning of the current industry trends can be leveraged by Customs to open new streams for value creation and value capture. For example, in the past some activities such as performing risk targeting using predictive models were extremely challenging because of the specific skill that is required to run it and the need to constantly rebalance the model weightings in order to reflect risk trends. Today, this can be easily automated due to sophisticated and intuitive data-driven technologies. On the other hand, an ecosystem typically brings together multiple players of different types in order to create, scale, and serve markets in ways that are beyond the capacity of any single organisation. This provides an opportunity for Customs to create partnerships and maximise opportunities to create new value.

At the **business level**, the process for creating and capturing the value for Customs is defined as follows:

- **Opportunities for new value creation:** the way of identifying and assessing the spectrum of broader opportunities is described in section 3. It encompasses the beneficiaries' segments profiles analysis, the right products/services selection to map each segment and the definition of the value offering.
- **Foundation for value creation:** refers to the resources (internal capacities and skills, partners and suppliers), the business activities and interactions, the technology and product features and the investment (cost) required to produce outputs and outcomes.
- **Value delivery and transfer:** concerns the output (products/solutions), the distribution channels and the onboarding and acceptance strategy.
- **Value capture and appropriation:** refers to the impact linked to the technology adoption and demonstrable value generated (or return on investment).

Figure 6 breaks down this high-level framework into a more detailed and logical prototype that specifies the key dimensions to consider for an effective AI technologies adoption governance. This canvas prototype is illustrated using the customer profile example developed in box 1 of section 3—AI technology adoption initiative to support a secure, trusted and facilitated trade environment—to make it practical.

Figure 6: Framework for adopting AI technologies in the customs environment

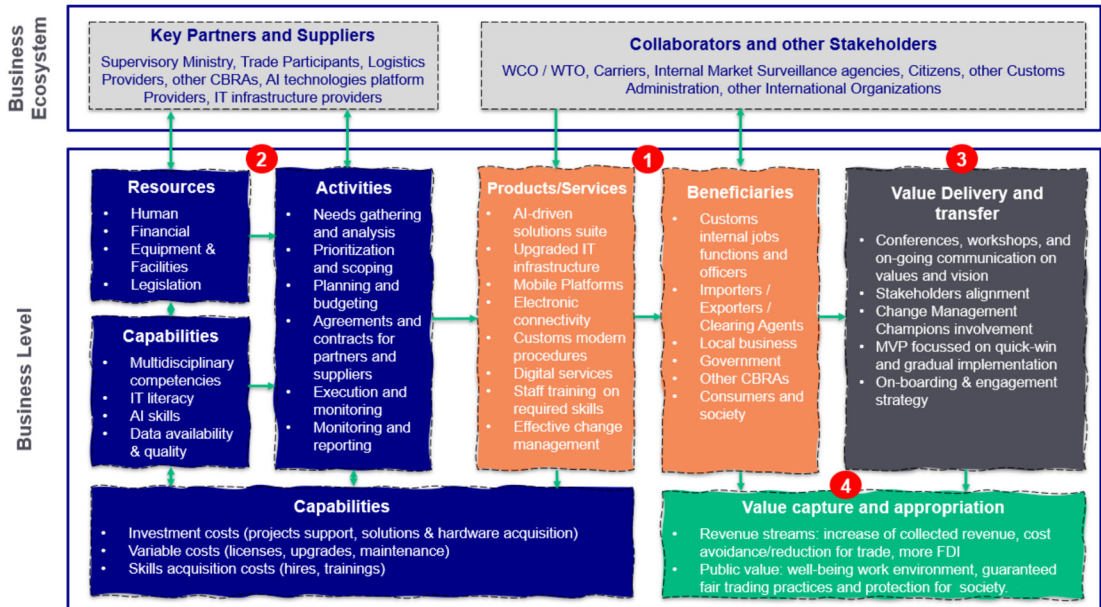

Source: Adapted from Martins, Mota and Marini (2019)

The particularity of the proposed canvas is its customer-centric approach.

1. The model starts from the customer segment profile (jobs, pain points and delights) to identify fit-for-purpose innovative solutions. It answers the following primary questions:
  - Who are the targeted audience(s)?
  - What are their characteristics?
  - Who are the most important beneficiaries?
  - What value (products and services) can be created for each beneficiary segment?
  - What beneficiary problems are being addressed?
2. It reviews the internal capacity (human, skills, equipment, facilities and data) versus the affordability to achieve the value proposition internally and the cost structure. It also focuses on leveraging the business ecosystem to build smart partnerships to ensure successful value creation and maximise the return on investment. It answers the following guiding questions:
  - What resources (profiles and essential skills) are important to achieve the value proposition?
  - What data do we have access to?
  - In what volume and quality?

- Can the current data format be used as it is?
  - What processes/projects are important to realise the value proposition?
  - What key activities need to be performed?
  - Who are the strategic suppliers?
  - Who are the key partners?
3. It then uses value delivery streams that accelerate time to value (using the Minimum Viable Product approach) and facilitate continuous communication, easy adoption and feedback. The following guiding questions can be used at this step:
- How is the value (products and services) provided?
  - Which channels engage more and are most cost effective?
  - Who are the champions (main influencers)?
  - What needs to be considered in terms of usability and user-friendliness of the technology to engage more?
  - Whose role will be affected by the new technology?
4. Finally, it connects the delivered solutions with the value appropriated by the beneficiaries enabling the fulfillment of their expectations, values, and interests. Questions to be considered are:
- Which needs, expectations, values, demands, and interests are being met?
  - How does the beneficiary make money or capture other forms of value?
  - What kind of public value is delivered?

## **5.2 Key considerations when adopting AI technologies**

It is recognised that AI represents huge opportunities for organisations like Customs to automate business processes and make their operations smarter. However, many customs administrations are failing to adopt AI because they are still uncertain about how to approach it. These are key considerations in unlocking the benefit of AI.

### **Need for political commitment**

Because AI adoption requires investment and disrupts the way Customs does business, customs executives should act as champions and be responsible for validating the AI initiatives, approving the selection of the use cases that will be considered, mobilising resources and enforcing decisions.

### **AI-savvy workforce empowerment**

A successful AI adoption in any organisation will require the development of both technical and managerial capabilities.

The management of AI technology also involves new managerial skills such as judgement-oriented skills, creative thinking and experimentation, data analysis and interpretation, and in-depth domain expertise. For example, fraud-targeting AI applications may reduce the time that managers spend looking for risk patterns but increase the requirements for interpreting the outputs combined with their expertise and ethics and drawing the final decision.

At the technical level, AI requires new technical job categories such as the next generation of machine learning engineers and AI products managers.

Customs administrations that have been best at adopting AI are using multiple paths for talent acquisition: internal talent upskilling and reskilling, new talent hiring, management and promotion.

### **Building on solid digital foundations**

AI works best when it has real-time access to large amounts of high-quality data. Therefore, it is critical to determine if the current IT systems and processes (information digitalisation and storage, paperless, accessibility, level of quality, computing capability, and security) are sufficient to adequately support the selected AI initiative.

### **Personal data protection and privacy**

AI requires access to important volumes of data. Customs policy makers need to carefully assess whether existing data access laws should be updated to maximise the benefits of AI. For example, when it comes to personal information, appropriate protection and privacy laws, data anonymisation requirements, and similar policies that balance privacy concerns against the benefits of AI must be considered.

### **Integration of AI technology with existing legacy systems**

In general, a legacy system that runs on heavily outdated software code does not work with modern application programming interfaces (APIs), making it impossible to connect with latest technologies.

Adopting AI technologies may imply updating existing components or rewriting part of the legacy code into a modern stack. This provides new interface to the legacy system, making it easily accessible to the modern AI software components.

### **Black-box effect and usability**

It is difficult for people to trust AI tools that make important decisions in an opaque way without transparency about the rationale behind the decisions. Because AI systems will assume responsibilities that used to be performed by humans, it is important that people understand how these systems make decisions. The lack of transparency—the black-box effect—increases adoption resistance (Kafando et al., 2014).

Good AI solutions should have user-friendly and intuitive interfaces that allow Customs end-users (generally non-technical personnel) to understand the logic behind the complex AI algorithms to quickly build their user experience and efficiently capture the expected value.

## **6. Conclusion**

In the current economic environment defined by globalisation, significant trade growth and an exciting digital disruption in the supply chain, the use of AI-based technologies is a critical enabler for cross-border regulatory agencies (CBRAs) to transform themselves in order to be more data and insight-driven organisations, and more resilient to a changing business environment.

Incorporating AI technologies and implementing the associated processes and procedures has the potential to help Customs radically reinvent their business models. However, in order to achieve the full potential, it is important to strategically involve all key stakeholders in a holistic approach to needs identification in order to define the use cases that address the most important challenges faced by Customs and the trade. The effort should primarily focus on use cases that offer the greater alignment between key stakeholder interests and that can be supported by cost-effective and reusable AI technologies. A strong strategy endorsed by a comprehensive and practical framework is the key to making the right investments for transformation.



From experience, successful integration of AI-technologies in the customs and trade environment depends on key considerations and requirements such as:

- The organisation's capacity to leverage partnerships and collaboration to co-create and scale AI-driven solutions within the customs environment.
- The need for political commitment to set and communicate a vision and drive organisational change.
- A solid digital foundation able to set up the proper data supply chain required to feed AI models.
- The development of both technical and managerial capabilities to effectively capture the value unlocked by AI technologies.
- The effective management of the technical and legal concerns related to AI technologies adoption.

AI promises huge benefits and many organisations, such as customs administrations, are just beginning their journey. This paper outlines critical success factors for successful AI experimentation in the customs environment and provides simple canvases to ensure ease of understanding and use. However, this paper does not intend to capture all factors that affect AI adoption and customs modernisation initiatives. Further research is recommended to test, refine and enhance the proposed tools in order to develop a more complete and robust AI – adoption framework for customs administrations.

## References

- Bocken, N., Rana, P., & Short, S. W. (2015). Value mapping for sustainable business thinking. *Journal of Industrial and Production Engineering*, 32(1), 67–81.
- Bocken, N., Short, S. W., Rana P., & Evans. S. (2013). A value mapping tool for sustainable business modelling. *Corporate Governance*, 13(5), 482–497.
- Deloitte. (2017). *Smart ports point of view*. Deloitte Port Services.
- Hsiao, C., & Tran-Thien, V. (2020). *Defining a successful AI project: A framework for choosing the right use cases* [Webinar]. Dataiku. <https://www.dataiku.com/webinars/defining-a-successful-ai-project>
- Kafando, I., Baranga A., & Zramdini, A. (2014). *Risk management implementation in Africa: Lessons learned*. WCO ESA, Trade Facilitation in East and Southern Africa, Chapter 2, p. 17–29.
- Martins, H. F., Mota, J. P., & Marini., C. (2017). Business models in the public domain: The public governance canvas. *Cadernos EBAPE.BR*, 17(1), 49–67. <https://doi.org/10.1590/1679-395167893>
- Osterwalder, A., Pigneur, Y., Bernarda, G., Smith, A., & Papadacos, T. (2014). *Value Proposition Design: How to Create Products and Services Customers Want*. New York: Wiley.
- World Customs Organization (WCO). (2008). *Text of the Revised Kyoto Convention. Chapter 7: Application of information technology*. [http://www.wcoomd.org/en/topics/facilitation/instrument-and-tools/conventions/pf\\_revised\\_kyoto\\_conv/kyoto\\_new/gach7.aspx](http://www.wcoomd.org/en/topics/facilitation/instrument-and-tools/conventions/pf_revised_kyoto_conv/kyoto_new/gach7.aspx)
- World Customs Organization (WCO). (2012). *SAFE Framework of Standards to secure and facilitate global trade*. [http://www.wcoomd.org/en/topics/facilitation/instrument-and-tools/frameworks-of-standards/safe\\_package.aspx#:~:text=In%20June%202005%20the%20WCO,and%20promote%20trade%20facilitation%20worldwide](http://www.wcoomd.org/en/topics/facilitation/instrument-and-tools/frameworks-of-standards/safe_package.aspx#:~:text=In%20June%202005%20the%20WCO,and%20promote%20trade%20facilitation%20worldwide)
- World Customs Organization (WCO). (2013). *Agreement on Trade Facilitation*. Bali. <http://www.wcoomd.org/en/topics/wco-implementing-the-wto-atf/wto-agreement-on-trade-facilitation.aspx>
- World Customs Organization (WCO). (2019). *Study report on disruptive technologies*. <http://www.wcoomd.org/en/topics/facilitation/instrument-and-tools/tools/disruptive-technologies.aspx>
- Wulf, L. D., & Sokol, J. B. (2005). *Customs modernization handbook*. World Bank.

## Notes

- 1 The analyses and views expressed in this research paper are those of the author, who remains solely responsible for any errors and/or shortcomings
- 2 Design Thinking is an iterative process that is used to understand users, challenge assumptions, redefine problems and create innovative solutions to prototype and test. It is a five-stage process which involves empathizing, defining, ideating, prototyping and testing.
- 3 A novel value mapping tool was developed to support sustainable business modelling, which introduces three forms of value (value captured, missed/destroyed or wasted, and opportunity) and four major stakeholder groups (environment, society, customer, and network actors).

### Ismael Kafando



Ismael Kafando is a statistics and econometrics engineer with over 14 years' experience in working with Customs and managing the conception and implementation of data analytics and risk management products for use in Customs and trade environment. He currently acts as product manager for the development of the new generation of COTECNA's AI-driven risk management and BI systems.

# World Customs Organization and global trade: imprints and future paradigms

*MM Parthiban, T Samaya Murali and G Kanaga Subramanian*

## Abstract

---

This paper traces the evolution of customs cooperation as an imperative of global trade, and the origins and achievements of the World Customs Organization (WCO). The birth of the WCO marked the first attempt at multilateral customs cooperation on a global scale, and this paper examines the challenges of customs cooperation since inception as well as emerging paradigms. After briefly tracing the early limited attempts to foster customs cooperation among sovereign states, this paper analyses the indelible imprints made by the sustained efforts of the WCO to simplify and harmonise customs procedures to facilitate international trade. The authors use inductive research methodology and link analysis to examine the impact of the WCO in developing standards and enhancing compliance for the ease of doing business in member countries in general and in India in particular. Our results suggest that there is a positive and robust effect of the WCO's instruments and programs in harnessing technology; in developing new paradigms and promoting their adoption by the customs and trade community; and in promoting communication and connectivity among member countries and peer learning. A detailed analysis on supply chain security as a contributing factor in achieving the vision of a globally networked Customs for a seamless flow of legitimate international trade is also presented. The paper argues that, in times of crisis, such as COVID-19 or any disaster of international scale, the need for a strengthened globally networked Customs becomes crucial. Under the future paradigms, a citizen-centric approach for sustainability of people, planet and prosperity is also addressed.

---

## Introduction

'What the bazaar economy lacks is not elbow room but organization, not freedom but form.'  
– Clifford Geertz, 1963.

Customs, as the name suggests, is antiquarian in origin. Given the relative permanence of terminology<sup>1</sup> and sovereign legal foundations of Customs throughout its history, is the institutionalisation of customs cooperation a new factor in the expansion of global trade in a contemporary era?

## Trade, tariff and customs cooperation from the beginning

The origin of customs duties is as old as the origin of cross-border trade—across the gates of the walled settlements in early history when sovereignty was at the incipient stage. The literary meaning of the word 'Customs' would imply, among other things, that a practice would become customary only after establishing harmonious relationships among the stakeholders. Since the beginning of cross-border trade in ancient times, harmonisation of customs procedures seems to have evolved by peer learning

necessitated by the need for ease of doing business (Ramdass & Subramanian, 2018). Not only was the tariff and the method of collection contemplated in many ancient codes of law, historic evidence indicates that ancient customs systems attempted to study the tariff regime of their trading partners also.

A fourth-century BCE Indian text, *Arthashastra*, links Customs and tariff thus: ‘In accordance with the customs of countries or of communities, the rate of duties shall be fixed on commodities, old and new.’<sup>2</sup> The Palmyra Customs tariff of Syria 137 CE links Customs and tariff thus: ‘pine cones and other similar goods imported by foreign merchants for the purpose of trade shall be taxed as dry goods, as is the practice in other towns’ (Asakura, 2003, p. 71). Further, as per *Arthashastra*, customs duty in foreign countries is to be reckoned as a factor by the superintendent of trade for deciding markets for the sale of the King’s goods.<sup>3</sup> The study of tariff requires knowledge of the system of classification and valuation of commodities. In addition, a conceptual study of the ancient customs system in the East and the West would show the striking parallels that existed between them, especially in the grouping together of a number of similar taxes under a general heading, suggesting harmonisation and a well laid-out composite taxation regime for regulating both internal and external trade: ‘*Śulka*’ in ancient India and ‘*Portorium*’ in ancient Rome for instance (National Academy of Customs Indirect Taxes and Narcotics (NACIN), 2018).

Customs cooperation from the ancient to medieval times was operationalised through the exchange of tributary missions, recognition of letters of permission for transit, and the principle of commercial extra-territoriality. The primary factor behind the ancient and medieval tributary exchanges between long-distance trading partners appears to be not strategic, but to secure customs concessions and market access.<sup>4</sup> The *Lex Portorii Asiae* (Customs Law of Asia) concerned with the customs dues of the Roman province of Asia from 75 BCE to 62 CE contains a provision for the exemption from import duties for conveyances in the course of transit (Cottier et al., 2008). The *Lex* also contains a provision for import duty exemptions in Pergamene harbour in light of what Augustus Caesar ‘decided and conceded or replied to the ambassadors’ (Cottier et al., 2008). Under the commercial extra-territoriality system, foreign merchants or a merchant guild in the native soil acted as a medium of trade between the host country and their home country and customs revenue was paid on behalf of the guild to the native state.

The Muziris papyrus (*Papyrus Vindobonensis G 40822*)—a second-century CE parchment in Greek, now housed in the Vienna Museum—is the surviving evidence for a trade agreement between the merchants of the host country and home country covering a transnational origin-to-destination supply chain secured by seals and validated by customs payment.<sup>5</sup> The central role of ancient terracotta seal impressions was to secure, identify and track consignments along the supply chain. One would wonder whether the ancient clay tags serve as archaeological evidence for the networked nature of Customs and refute the notion of Customs as a gatekeeper at a single node in the supply chain (NACIN, 2018).

It is curious to know that valuation often caused headaches for both Customs and the traders even in the pre-modern period.<sup>6</sup> The Portuguese observer Tom Pires, in his *Suma Oriental* (1512–1515 CE) records at Malacca in Southeast Asia, the King’s common practice of calling together a group of 10 merchants belonging to different nationalities settled in the port town for customs valuation of the goods that had arrived in large ships (Pires, p. 273). As it is seen, Customs and tariff were intertwined throughout history and customs cooperation between sovereign agencies was localised, transient and volatile.

With the industrial revolution and the consequent search for markets, customs cooperation started to grow methodically. It saw the emergence of treaties and customs unions, such as the German customs union, the *Zollverein*. However, it appears that no distinction was made between Customs and tariff until the end of the nineteenth century; Customs is considered to be synonymous with tariff metonymically. As shown by Pahre (2007), the politics of trade cooperation during 1815–1914 CE centred around the ‘agreeable customs’. While tariff was the recurring theme of trade agreements in the early modern period, themes relating to the safety of supply chain by the suppression of non-state actors could also be

found. The Bhavnagar-Surat Customs Cooperation Treaty 1739 (Ramdass & Subramanian, 2018) and the Treaty of Tianjin, 1858 (van de Ven, 2014), contained provisions for the suppression of piracy along the Saurashtra Coast and China Coast respectively, with the cost to be met from customs revenue.

The limits to market integration were transformed into barriers under the guise of protectionism at the start of the twentieth century. The differentiation of customs rates and customs procedures as tariff and non-tariff components began to emerge in the context of negotiations for international economic cooperation. The origin and parallel evolution of the General Agreement on Tariffs and Trade (GATT)/WTO and Customs Cooperation Council (CCC)/WCO and their contributions to the expansion of cross-border trade in the contemporary era could well be linked to that differentiation.

In the absence of a specific intergovernmental organisation, the efforts towards evolving efficient customs procedures at the international level ended only in talks as they could not scale the walls of state sovereignty. The League of Nations started the negotiations on uniform customs nomenclature, the coding and classification of the tariff items as a first step, but it could produce only a draft nomenclature before the outbreak of World War II.

In the aftermath of World War II, the Committee for European Economic Co-operation was established in 1947 to contribute towards post-war recovery in Europe. While considering trade as an engine for economic development, it envisaged customs cooperation as an imperative for trade. This led to the setting up of a Customs Committee in 1948 in furtherance of its objective of establishing a Customs Union for Europe based on the GATT principles, which entered into force the same year. GATT has a number of provisions closely relating to customs and tariffs, underscoring the importance of customs cooperation in trade issues (Asakura, 2003, p. 280).

The need for institutionalising customs cooperation led to the Convention establishing a CCC in 1950. Accordingly, the CCC was founded in Brussels in 1952. The spirit of the Convention, as enunciated in its preamble, is to promote cooperation between governments in customs matters in the interests of international trade, once again underscoring the importance of customs cooperation in trade issues. The concept of a global organisation for the sovereign agency of nations (customs) was entirely new. The founding members of the Convention were all European governments as they already were part of the grand dream of establishing a customs union and the spirit of the Convention is well served by the provision for admission of new members and even non-member governments in the capacity of observers, which helped to extend its influence beyond Europe quickly.

The post-World War II global trade system also saw the dismantling of the colonial yoke and the emergence of free world economies. The initial work of the CCC, especially relating to Brussels Definition of Value (1953) and Brussels Tariff Nomenclature (1959), attracted the attention of the world and its membership grew. With the growth in membership, the relevance of the CCC grew, and its approaches and activities were widely accepted by the trading nations and international forums. It now covered all six regions in the world. The council for securing harmony and uniformity in customs techniques has since expanded through its technicality, fraternity and professionalism into the voice of international Customs family *sans pareil*.<sup>7</sup> It adopted the working name World Customs Organization (WCO) in 1994. In terms of the number of members, it is the second largest of the intergovernmental organisations (183 contracting parties), next only to the United Nations System Organisations (Asakura, 2003, p. 290).

The major achievement of the CCC was incorporating a global paradigm in the customs administrations and in building their capacity to deliver results by developing instruments and standards, policy dialogue and information exchange. The contemporary challenge to customs cooperation is the ramifications of the supply chain deep into the domestic markets on both sides of the border, requiring synergistic efforts of Customs among themselves and with other enforcement agencies as well as business stakeholders to promote legitimate trade.

Whether the vast vacant niche for global customs cooperation was occupied or created by the CCC is an interesting research question. The imprint of the WCO is felt across the world in orienting customs administrations, benchmarking, providing additional tools, enhancing partnerships, promoting academic and research agenda, capacity building, and replicating best practices and communicating the results. The cross-border customs infrastructure supporting global trade, as we see today, is the result of collaborative efforts steered by the CCC for seven decades. Riggs and Mykletun (1979) concluded that the CCC was among the few international agencies that evoked consistent and enthusiastic appraisals as well as respect for the things it did, especially in developing a harmonised system of nomenclature for the classification of goods and valuation by the customs administrations.

The success of the CCC is attributable to its responsibility and capability for accelerating cooperation between customs administrations, its fine balancing between trade facilitation and enforcement of trade laws, and its futuristic orientation. Its success is imperative for customs administrations, global trade, and humanity at large, as it is the only intergovernmental organisation dealing with multilateral customs cooperation at a global level.

### **The base for the ease of doing business**

Historically, Customs is the first official institution that greets foreign merchants as they enter sovereign borders. Borders divide, Customs connects (WCO Vision Statement). Close relationships exist between trade cooperation and customs cooperation—the two are arguably cause and effect and are evolutionarily related. The technical grounds for multilateral trade cooperation depend much on the groundwork done by the CCC, as Customs cooperation is a prelude for trade liberalisation and expansion. The succession of globalisation is pioneered by multilateral trade negotiations through the development of global conventions. While legislations on Customs are under the sovereign authority of member countries, they now echo the spirit of these international instruments and the role of the CCC in bringing about the transformational change establishing the base for the ease of doing business highlighted here.

### **Harmonisation of tariff nomenclature**

Tariff nomenclature—the coding and classification of commodities for the determination of customs duty—was a major area of discussion at the beginning of multilateral trade negotiations relating to the removal of non-tariff barriers. Since different states framed their tariffs with different objectives, it was difficult to arrive at a common detailed nomenclature that would meet the requirements of all.<sup>8</sup>

In 1929, a draft framework for customs tariff nomenclature was prepared by a sub-committee of Experts of the Economic Committee of the League of Nations. The draft Uniform Customs Nomenclature was approved by the Assembly in 1931 and sent in November 1932 to governments for their observations. It was generally agreed that any steps towards uniformity of nomenclature would tend to facilitate international trade and should, therefore, where practicable, be supported. However, in view of the various observations and amendments proposed by countries for drawing up a final text, it was hoped that a time would come in the near future to conclude an international agreement for putting into force a new system of customs nomenclature. Analysis of the draft Uniform Customs Nomenclature showed that the criticisms of over-elaboration and little flexibility in it were caused by the desire to bring uniformity into customs nomenclature. The paradigm shift was brought by the CCC by envisaging harmonisation rather than unification of tariff nomenclature. It was a time when such common nomenclature was called by different names.<sup>9</sup> Obviously, the development of a harmonised system of nomenclature (HSN) by the CCC was closely linked to the GATT multilateral trade negotiations in Geneva.<sup>10</sup>

It took 17 years (1970–1987) for the CCC to bring into force the Harmonized Commodity Description and Coding System by modernisation of the Brussels Tariff Nomenclature (BTN) in conformity with the latest industrial and commercial requirements. The long gestation period produced a dynamic living

document, the pedigree of which performs different roles according to the needs of the time. There is mention now of the Harmonized System (HS) supporting environmental control measures on goods of concern at the border. The 2022 edition of the HS will include specific HS codes for the most commonly traded HFCs and mixtures to help Customs in the fight against climate change (WCO, 2020). With 159 contracting parties, the HS Convention made effective inroads into customs legislations and, with its application across 212 countries, territories and customs or economic unions, it serves as a mutually beneficial instrument for the customs and trade community and is the primary factor in ensuring a seamless flow of trade across the borders.

## Valuation

The development of an international customs valuation system has seen the long history of cooperation between the WCO and the WTO.<sup>11</sup> The administration of *ad valorem* tariffs primarily involved questions of customs technique and the CCC has been dealing with such questions at an international level since its inception.<sup>12</sup> Determining a real value is prescribed in the GATT Article VII (WCO, 2010). However, differences in the interpretation of GATT provisions led to changes in the system of valuation across nations constituting non-tariff barriers (NTBs).<sup>13</sup>

The free on board (FOB)–cost, insurance and freight (CIF) issue was one of the unresolved differences in valuation although both bases are allowable under Article VII of GATT. Against this backdrop, the Tokyo Round GATT Multilateral Trade Negotiations (1973–1979) took place, which finally led to a new GATT Code on Customs Valuation that came into force in 1981 (De Pagter & Van Raan, 1981). De Pagter and Van Raan (1981, p. v) wrote:

As a result of the new agreement a uniform system for the valuation of goods for customs purposes will be used for the first time in history of international trade by the most important trading nations.

Article 18 of the Agreement on implementation of Article VII of GATT, 1994 provides for a Technical Committee on Customs Valuation under the auspices of the CCC. This committee represents the first major joint operational effort between GATT and CCC, representing the interrelation between Customs and trade.<sup>14</sup> This committee gave technical assistance to the developing nations and interpretation on specific technical problems arising in the administration of the customs valuation system of members as per the provisions of the GATT Agreement. To ensure an internationally uniform application, this committee has also undertaken the task of publishing Explanatory Notes to the Code (WCO, n.d.b).

The WCO, over the years, has organised workshops on the provisions of the WTO Customs Valuation Agreement, especially for the capacity building of customs officials in the developing and least developed countries on technical topics such as related party transactions, licence fees and royalties. Nowadays, such workshops align their focus on trade facilitation themes, such as valuation in the context of advance rulings and post-clearance audit.<sup>15</sup>

## Rules of origin

In the late 1980s, due to the proliferation of preferential trading arrangements, quota restrictions and anti-dumping issues, customs administrations faced challenges regarding the origin of consignments. The paperwork requirements on certificates of origin occasionally caused delay in the clearance of incoming or outgoing shipments. There was a general lack of consistency between customs administrations on the application of rules of origin, especially in cases of non-preferential origin. In order to overcome this barrier, the Agreement on Rules of Origin in 1994 was incorporated in the Uruguay Round of GATT. The Agreement on Rules of Origin is the collaborative result of the WTO Committee on Rules of Origin (CRO) and the WCO Technical Committee on Rules of Origin (TCRO). Now it serves as the global standard for trade policy, trade statistics and general macroeconomic analysis (WCO, n.d.a).

## Customs procedures and trade facilitation

In the CCC's efforts towards trade facilitation, two strands appear in tandem: one relates to technical cooperation and the other to operational issues. Technical cooperation is a classic example of cooperation amongst customs administrations and solutions to the basic challenges in the application of customs techniques, such as classification, valuation and origin, are arrived through the constitution of technical committees, policy dialogues and drafting of conventions involving customs experts. Although operational issues could be simplistically coalesced as trade facilitation through the simplification and harmonisation of customs procedures, customs cooperation in operational issues, such as supply chain security, the single window concept and coordinated border management, require not only Customs-to-Customs partnerships but also partnerships with other agencies at national and global levels. The significance of the new instruments and tools developed by the WCO, such as Revised Kyoto Convention, SAFE Framework of Standards, and Time Release Study, must be seen in this context.

The following analysis links the quantum of work done by the WCO towards trade facilitation starting from the watershed year 1994.<sup>16</sup>

After settling the basic challenges in customs techniques, the CCC started the work of revising its main trade facilitation convention, the Kyoto Convention, in 1995. The Revised Kyoto Convention (RKC), which entered into force in 2006, is concerned about simplification and harmonisation of customs procedures for faster clearance. It is aimed at improving customs competitiveness, quality of service and consumer satisfaction. It may be noted that Section I of the WTO Trade Facilitation Agreement, which entered into force in 2017, contains provisions for expediting the movement, release and clearance of goods, including goods in transit. Two new paradigms brought by the RKC—risk management systems and post-clearance audit—now serve as the norms for balancing facilitation and enforcement and these paradigms changed the way Customs functions. The RKC recommended maximum use of information technology in customs operations, which brought about a positive turn-around in clearance times. Technology has enabled reduced paperwork and human interface and has enabled faceless assessment. The role of the WCO in harnessing technology for faster clearance is further exemplified by the adoption of RFID e-Seals, non-intrusive scanning methods and data modules for risk management by the members.

A plethora of certificates are replaced by the system of declaration. Export and import documentation and customs clearance forms are standardised across the global supply chain. Unreasonable delays in formal customs clearance and excessive penalties for errors in customs documentation are greatly reduced by the application of RKC standards. Certainty and predictability are added to the customs operations by the application of general rules, such as advance rulings, as enunciated in RKC. The tools promoted by the WCO, especially the single window concept and Authorized Economic Operator (AEO) program have wider ramifications in the business atmosphere and other line departments of Customs. The capacity building programs of the WCO now also cover the business and trading community. Customs is now empowered to make partnerships with trade through the program. Pre-arrival declaration systems and AEOs play an important role in getting advance information and reducing delays. The WCO now has a package of tools for each aspect of trade facilitation through Customs. It is not an exaggeration that the customs administrations would take a lead role in facilitating trade using these tools.

The work of the WCO towards trade facilitation is held in high regard by both developed and developing countries. The WCO is counted as one among the key forums shaping the future of the global economy.<sup>17</sup> The advisory opinions of the WCO are consulted by courts in member countries to decide issues relating to customs techniques, for example, to determine the meaning of a tariff provision (Malkawi, 2019, p. 311).



Two paradigms are identified in ensuring compliance to trade facilitation measures: one is by encouraging compliance and the other is by enforcing it. Both these paradigms require internationally accepted standards and instruments for evaluation of compliance.

While analysing the responses from customs administrations regarding the causes for customs modernisation, two usual answers would be encountered: one is increase in global trade and another is to meet the WCO standards. The best part of the functioning of WCO is 'encouraging compliance by support', in addition to development of standards and instruments. The WCO provides support to member countries by focusing on their practical needs and then developing tailor-made solutions through various tools to ensure compliance. This is illustrated with the following case study.

The WCO Revenue Package program aims to assist member administrations in fair and efficient customs revenue collection. While commencing work on the action plan of the Revenue Package program, the challenge faced by many countries in the application of the WTO Valuation Agreement was identified as the major issue impinging revenue collection and members requested further assistance in this area. Accordingly, the WCO focused a study on best practices in valuation control programs in select member countries, including a study of Indian Customs' valuation database system, as such databases may be of use as a risk assessment tool (WCO, 2011). The best practices are then actively promoted as part of the Revenue Package program so that member customs administrations could effectively function both as revenue collectors and trade facilitators.

By motivating economies for higher rankings, the Ease of Doing Business (EODB) index enforces voluntary compliance to trade facilitation instruments. Okazaki (2018) finds that all of the trading across borders indicators in World Bank Groups' EODB relate to customs procedures (Okazaki, 2018). While illustrating the efforts of countries to score higher in the EODB index, he highlights the efforts of countries towards implementing the standards, tools and recommendations long advocated by the WCO. For example, in the case of India, he uses the example of the implementation of the single window interface to facilitate trade and reduce the number of mandatory documents for import and export. Another way of enforcing compliance is through dispute settlement mechanisms, as exemplified by the WTO. Hence, by developing instruments, standards and tools, and by providing technical support for compliance with those standards, the WCO makes it easy for its members to have tailor-made solutions for ease of doing business.

While contemporary customs administrations could effectively tackle traditional challenges relating to cargo release time, challenges to supply chain security and trade facilitation requiring capacity building and synergistic efforts still remain.

Figure 1: Top 5 measures with highest implementation rate

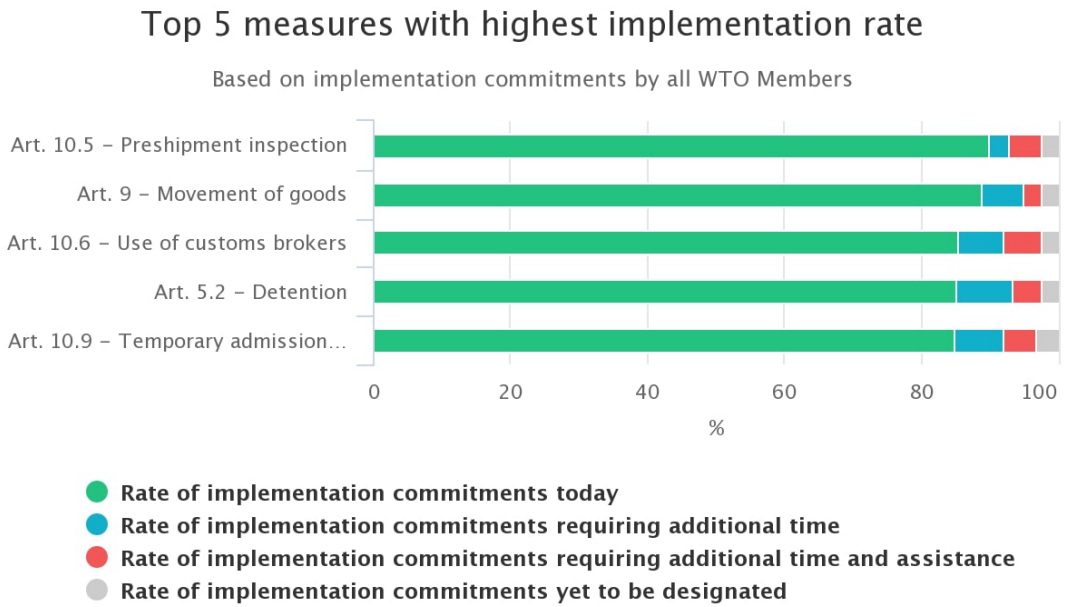

TFAD (Trade Facilitation Agreement Database) [www.tfadatabase.org](http://www.tfadatabase.org)

Source: WTO Trade Facilitation Agreement Database, 2020

Figure 2: Bottom 5 measures with lowest implementation rate

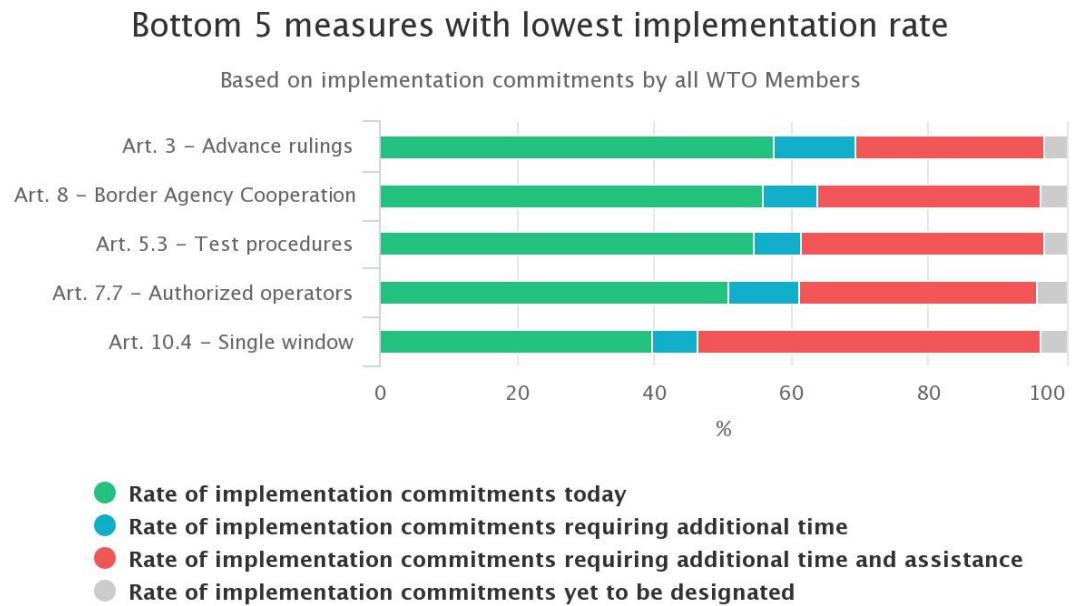

TFAD (Trade Facilitation Agreement Database) [www.tfadatabase.org](http://www.tfadatabase.org)

Source: WTO Trade Facilitation Agreement Database, 2020

The above data (Figures 1 and 2) from the WTO TFA database helps to analyse the achievements and challenges for Customs in facilitating trade. An analysis of the top five trade facilitation measures (Figure 1) reveals that these measures are solely under the prerogative of Customs, more concerned with basic customs procedures, and these measures are implemented by the contracting parties to the RKC. The bottom five measures with lowest implementation rate (Figure 2) are found to require partnerships between Customs and other agencies. They are more concerned with enhanced controls and domain issues. These measures require capacity building, outreach and adoption of synergistic paradigms. Hence the need for additional time and assistance for compliance with these measures.

## **Supply chain security and Globally Networked Customs: a network of realities**

In the evolutionary sequence of customs cooperation, Globally Networked Customs (GNC) would be the climax. WCO instruments and recommendations underscore the importance of the exchange of information relating to supply chain to protect society, public health and safety. With ever increasing container volumes across the world, seaport and airport growth, and unpredictable port selection and usage, it is essential to create a strong and safe supply chain security system. Supply chain security requires a consistent approach towards strengthening cooperation between customs administrations, between Customs and other enforcement agencies, and Customs-to-Business partnerships. GNC envisages cross-border exchange of data among customs administrations along the supply chain. In a globalised world, supply chains, covering the origin(s), destination(s) and in-between(s), are transborder by nature. Supply chain security implies origin-to-destination security of the cargo. There should be effective security procedures and controls from the point of stuffing of cargo. Using technology such as RFID e-Seals; various detection methods including geofencing and reporting path diversion; and non-intrusive examination techniques like scanning; container and trailer integrity must be maintained to protect against the introduction of unauthorised material and/or persons during transit. Creating global solutions for supply chain visibility, security and predictability is the key to trade facilitation and it will also foster efficient and resilient supply chains by filling in any gaps. Supply chain security is the axis connecting the twin tracts of GNC—in other words the commercial track and enforcement track, as riskiness of transactions is the overlapping theme in both the tracts. Therefore, the authors consider supply chain security as the predominant factor contributing to the evolution of GNC. Five paradigms are identifiable in the efforts of Customs to ensure supply chain security. These paradigms range from being local at a Custom House to the global level.

1. A global risk management system
2. A global single window for compliance
3. Customs mutual administrative assistance
4. Customs overseas intelligence networks
5. Authentication by scanning or physical examination.

In addition to the intelligence exchange with the member administrations at a strategic level, Regional Intelligence Liaison Offices (RILOs) were established by CCC in 1987 as an added layer of information exchange. True to its intention, the RILO network, with 11 nodes, now serves as a global intelligence network covering all six WCO regions. A depository of enforcement-related information is continuously updated via the WCO Customs Enforcement Network (CEN) application. By its design as a global database for seizures and offences, CEN acts as a communication network that carries information. For instance, in 2010, the CEN database shared information on over 50,000 seizure cases related to narcotics, intellectual property rights (IPRs), weapons, currency smuggling and tobacco.<sup>18</sup> This paradigm is further

reinforced by the information exchange requirements of contracting parties to the United Nations conventions on narcotics and illicit trafficking and also by the customs risk management system and nCEN platforms at national level, both of which help in identifying and tracking specific nodes in the supply chain. A global risk management system, with the active participation of member countries in sharing real-time information of sensitive cargo movement, will create an effective environment for detecting and tracking illegal movement of sensitive cargo. The greatest advantage of such a system would be the detection of potential risks in the supply chain at the earliest moment. A global risk management system must focus on establishing global risk parameters to identify high-risk containers, pre-screening of those high-risk containers at the origin port through non-intrusive technology, if possible, to reduce time, and passing on the information to the destination port before the arrival of the container for necessary action.

Linked to it is the next paradigm, a global single window for compliance. This paradigm could be the logical evolution of the AEO framework. The details of national AEOs are now available. This paradigm is increasingly reinforced by mutual recognition agreements (MRAs) for AEOs between customs administrations (WCO, 2011). Seventy-four bilateral and four regional/plurilateral MRA–AEOs were already concluded indicating that they have the potential and experience for Business-to-Customs exchange. Sixty-five MRA–AEOs are being negotiated. Even a relatively static database of national and mutually recognised AEOs at the global level would greatly help in compliance assessment, trade facilitation and risk management. A study on customs cooperation of WCO member countries with their major trading partners through the instrument of MRA-AEOs was carried out and the results are depicted in Table 1 showing current MRAs of WCO member countries with their top five trading partners.

*Table 1: Level of cooperation among major trading partners in the field of Customs-Business exchange through MRAs*

<b>WCO member countries: MRA-AEOs with top-5 trading partners</b>	<b>Export partners</b>	<b>Import partners</b>
Number of countries having MRA with at least one of their top 5 trading partners	10	9
Number of countries having MRA with two of their top 5 trading partners	6	7
Number of countries having MRA with three of their top 5 trading partners	7	9
Number of countries having MRA with four of their top 5 trading partners	19	14
Number of countries having MRA with all the top five trading partners	9	11

*Source:* Compilation from WCO Compendium for AEO Programmes, 2019 edition and World Bank WITS Data, Base year 2018

A key component for promoting trade facilitation is having a single window system. Many countries have now implemented single window clearance, covering major agencies involved in the import/export of cargo. A few regional-level single window arrangements are also in place for the purpose of sharing information. The next step is to extend and integrate these systems beyond national boundaries to make it a ‘global single window’ system. This single window could be designed to utilise the unrealised potential of MRA-AEOs too. In addition to priority treatments, future developments in AEO programs could extend to member countries considering accepting documents submitted and other regulatory requirements completed at the port of origin and that should be accepted at the importing country to avoid duplication of work to further strengthen the seamless movement of international cargo.

A global single window where the integration of the single window of a country with other national single windows for MRA-AEOs, initially, would strengthen the global supply chain by approving participants in the supply chain. A global single window would further facilitate trade through the submission and verification of trade-related information or documents at a single entry point to fulfil all trade-related regulatory compliances. The major benefits of a global single window include faster clearances, a more transparent and predictable process, more governance and less government, enhanced compliance, and a secure supply chain.

Customs mutual administrative assistance (CMMA) is the earliest paradigm of customs cooperation in the field of supply chain security. Based on the impetus given by a recommendation of the CCC in 1953, analogous frameworks for exchange of information were operationalised by customs administrations through bilateral agreements. It is now a global phenomenon. One hundred and thirty-seven customs administrations and members of the European Union are a part of CMAAs, indicating that they have the potential and experience for Customs-to-Customs exchange. The European Union, Eurasian Economic Union and South Asia Subregional Economic Cooperation (SASEC) provide the examples for regionally networked Customs. The European Union showed the way for CMAA and MRA-AEO agreements between the Customs Union and customs administrations from other regions. This paradigm is further reinforced by Article 12 of the WTO TFA, which provides for Customs-to-Customs exchange of information. Article 12 provides for the flow of information between the requesting member and the requested member. As it supports bringing data together only between two members, it is bilateral by design. However, with 149 contracting parties to the WTO TFA, this paradigm provides the potential for the network of networks. A study on customs cooperation of WCO member countries with their major trading partners through the instrument of CMAAs is carried out and the results are depicted in Table 2 showing CMAAs of WCO member countries with their top five trading partners.

*Table 2: Level of cooperation among major trading partners in the field of Customs-Customs exchange through CMAAs*

<b>WCO member countries: CMAAs with top five trading partners</b>	<b>Export partners</b>	<b>Import partners</b>
Number of countries having CMAAs with at least one of their top five trading partners	40	39
Number of countries having CMAAs with two of their top five trading partners	14	18
Number of countries having CMAAs with three of their top five trading partners	20	19
Number of countries having CMAAs with four of their top five trading partners	26	18
Number of countries having CMAAs with all the top five trading partners	11	15

*Source:* Compilation by pooling of CMAA related information and World Bank WITS Data, Base year 2018

The time-tested network of networks is Customs Overseas Intelligence Networks. They collect data overseas and transmit to the targeting centres of the customs administrations. Their transborder role is of immense help in ensuring supply chain security in addition to checking customs fraud, trade-based money laundering and smuggling. Their orientation is at national level as they support their customs administration. However, this paradigm provides an internode for the networks as pooling of information is usual practice among intelligence networks.

The fifth in the list is the traditional paradigm, authentication by scanning or physical examination at Custom House level. It is noted for its unpopularity and impracticability with the growing volume of trade. One would wonder whether all other supply chain security paradigms owe their existence due to the undesirability and impracticability of this paradigm. However, this paradigm still acts as a deterrent for high-risk containerised shipments and is also useful as a random compliance assessment tool. However, sharing of information in the event of detection of major cases is the key to GNC.

From the above analysis, we highlight that discrete networks exist at different levels and they share a common objective. The genesis of GNC lies in specific exchanges between countries from a regulatory standpoint, Customs being the sovereign cross-border regulatory agency. Customs administrations are striving to ensure compliance with international supply chain security standards through different paradigms while promoting trade facilitation by faster clearance. GNC would be elusive only until the emergence of an internode connecting the discrete nodes. Network theory proposes that evolving networks mature as a function of time and the networks converge as a result of evolutionary pressure on the existing networks. Four of the five supply chain paradigms discussed here are evolving ones and are not static. The need for supply chain security is augured well by the need for trade facilitation as trade facilitation is a function of compliance. Supply chain security covers trade facilitation and goes well beyond by ensuring sustainability for the people and planet. Temporal themes in supply chain could be the immediate possible internode connecting the existing nodes for achieving the concept of GNC—interconnectedness for ensuring seamless supplies in the event of a pandemic, for instance.

### **Customs citizen-centric approach for sustainability**

By letting in legitimate goods and shutting out harmful items, Customs serves as the sentinels of economic frontiers. The role of Customs is not limited to trade, as it includes international passengers and other agency functions also. The modern customs laws and regulations are designed so that traders can choose among a number of procedures. There is a need for Customs to place the citizen as the central focus, by transforming the procedures from process-centric to citizen-centric, especially in areas where the liability to pay cannot be shifted, for example in postal customs and e-commerce. Given the increasing miniaturisation of consignments for individuals, postal customs and e-commerce gain prominence in customs policy.

Clarion calls for Customs to foster sustainability for the people, prosperity and planet and enhancing the ease of living of the citizen indicate the future paradigms in customs administration (WCO, 2020). Timely clearance of goods, with substantial savings in time and money, would be a small step towards this goal.<sup>19</sup>

### **The right queue**

The basic queuing model employed by Customs is being fast replaced with client-centric models. Guidelines on a dual channel system have been prepared by the Permanent Technical Committee of the WCO. It helps in the hassle-free movement of passengers in airports. At port terminals, direct port entry and direct port delivery help significantly in reducing both cargo clearance costs and time for export and import containers by allowing 24x7 clearances.

The application of queuing theory to customs operations provides a mathematical paradigm to improve efficiency and effectiveness, not only in times of tremendous increase in international trade, transit and travel, but also in times of humanitarian relief. This emerging paradigm has great potential for the future for two reasons: saving time through optimising the performance of existing resources and improving enforcement capability. The evolution of this paradigm would depend on IT systems and databases for assorting, prioritisation and communication, both for facilitation and enforcement. Rather than just using the available data, customs administrations have started acquiring required data by customs declarations

and integration with internal tax networks. By embedding the domain expertise of Customs into the data analytics system, this paradigm is expected to create composite channels for customs operations. Such a channelling system would incentivise compliance by faster clearance and would help Customs in risk profiling to focus on smuggling and counterfeiting through small parcels. It would also help Customs to predict the arrivals and clearance time in practical situations.

### The queue and trade facilitation

As the volume of trade across the borders is significantly increasing, the necessity for prioritising cargo is of increasing importance. Accredited clients like AEOs, globally recognised NGOs, Government enterprises and relief consignments during crisis situations need to be prioritised and their consignments should not be lined up with other consignments. The first in first out system in a normal queuing model should be altered to provide faster clearance for accredited clients subject to other risk assessment methods. This will incentivise the rule-bound clients and act as a bonus for business entities. Rather than queuing, right queue is the key factor here. Queuing prioritisation should be directly proportional to the level of compliance and the accredited status of the stakeholders. Figure 3 illustrates a model of queueing prioritisation for facilitation of emergency relief cargo and AEOs.

Figure 3: The queue and trade facilitation

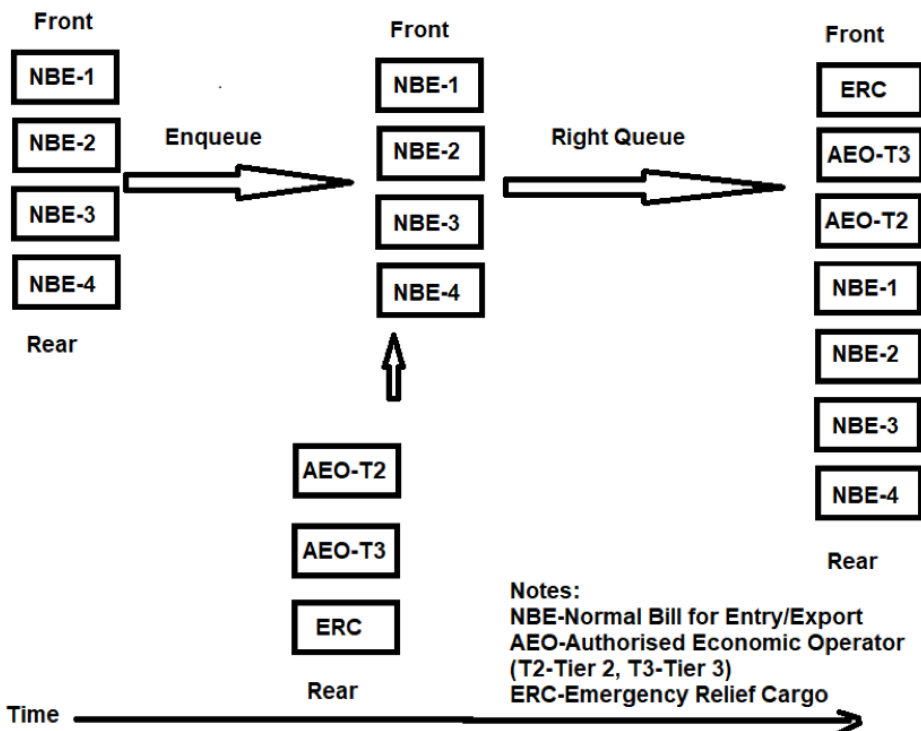

### Two-factor authentication system for e-Commerce

As the past unlocks the secrets to the future, let us consider for illustrating a queue model, a two-factor authentication system employed by the ancient customs administrations for faster clearance. The two-factor authentication system was operationalised through double concomitant seal impressions on the clay tags for ancient consignments, wherein one seal is apparently a self-seal and the other seal acting as counter-seal, attesting or endorsing it. In some cases, the self-seal appears to be that of a merchant

and the counter-seal impression belonged to a merchant guild. In other cases, the self-seal appears to be that of a merchant guild and the counter-seal impression belonged to a royal personage. Repurposing the two-factor authentication in a contemporary scenario, let us consider a composite two-factor channel for information flow through IT systems. The factors for authentication could be combined in different forms: pre-arrival declaration/compliance information by the consignee (vs) information sourced from e-Commerce database; pre-arrival declaration by the intermediary (vs) compliance information by the consignee; information sourced from e-Commerce database (vs) random checks by Customs; information sourced from e-Commerce database (vs) customs databases or databases of partner enforcement agencies. IT-enabled simple pre-arrival declaration/compliance information by the consignee is contemplated to authenticate the origin-to-destination supply chain here because the sender/intermediary submits the customs declaration for postal consignments for example. Allowing such pre-arrival declaration/compliance information is also expected to help in the prediction of arrivals and profiling. The two-factor authentication system would act as a risk management system, build trust, simplify issues related to return/reassessment of goods and is expected to reduce the need for opening and examination, thereby promoting faster clearance at times of tremendous increase in the number of consignments.

### Green Customs

Among all forms of indirect taxation, Customs stands out as being concerned with legitimate cross-border trade or, rather, the movement of legitimate consignments. It is heartening to find that this privileged position assists customs administrations in their global fight against climate change, wildlife trafficking and cross-border movement of hazardous chemicals and wastes. The lucrative business of illicit trafficking of endangered species and harmful environmental goods could threaten the sustainability of the ecosystem and human health and would lead to species loss and failure of international environment agreements by circumventing the agreed rules (Green Customs, n.d.). In addition to the termination of illicit trafficking supply chains, the Green Customs enforcement activities are potently symbolic and induce behavioural changes en masse. The massive seizures of environmentally sensitive commodities, toxic chemicals, hazardous waste and endangered species by Customs over the years have left the public wonderstruck and contributes to consensus-building for the protection of the planet. Customs and other border agencies are well aware of their ever-increasing role not only on the trade front but also for environmental protection.

Future Green Customs initiatives by the WCO should focus on improving and promoting the trade volume of environmentally friendly goods and low carbon goods, which will contribute to sustainable development. The reduction of tariff rate, non-tariff barriers and making green technologies accessible to developing and least developed countries at low cost should be given priority. Specialised treatment to trading of environmental goods should be devised by each customs authority and goods that are directly or indirectly used for producing environmentally friendly goods/green goods should be given fast-track clearances.

### Humanitarian Customs

Much is talked about the expanding role of Customs. In the ever-expanding role, the readiness of Customs in the event of a humanitarian crisis and concerns about the impact of trade and movement of people across borders during the crisis is the need of the hour. Supply chain slowdown in the event of a pandemic is a relatively unexplored area of customs cooperation. During such unexpected crisis situations, every effort taken as a measure of trade facilitation by countries will have substantial impacts on the entire relief chain; customs procedures during transit are particularly relevant for disaster-affected landlocked countries for avoidance of additional delay in the arrival of relief items shipped by sea and transiting through a third country.<sup>20</sup>



As an early response against the emergent situation on account of the coronavirus (COVID-19) outbreak, the Central Board of Indirect Taxes and Customs, Government of India, introduced 24x7 clearances at all customs formations and also set up a trade helpdesk for EXIM trade stakeholders for providing the required assistance and resolving issues through coordination with relevant agencies. To illustrate, Meerut Customs Zone and Delhi Customs Zone of Indian Customs set up on-ground facilities at designated places for the smooth processing of Indian citizens who returned from affected countries. Keeping in mind the exigency because of COVID-19 in China, and in order to facilitate clearance of the consignments, the Chennai Zone of Indian Customs decided in the public interest that Bills of Entry filed late for clearance of import consignments from China would not attract any late fee charges as the documents were stuck inside locked offices of shippers at Chinese cities. This decision was hailed as a double bonanza to consignees and agents as it also avoided containers that arrived from China being stranded. Consciously relaxing procedures to avoid financial losses for stakeholders during such a crisis serves to demonstrate that Customs cooperation is imperative for trade. The capability to defeat the spread of the pandemic at lower cost depends much on the early supply of reinforcements at the start of the problem in order to enhance the preparedness.

In this context, provisions expanding the scope of Chapter 5 Annex J of the Revised Kyoto Convention dealing with relief consignments shall be analysed. The spirit of Chapter 5 would be better served if it brought a protocol for clearance of dutiable consignments for relief in humanitarian emergencies under a fast-track mechanism. This would avoid the emergency relief consignments lining up with other consignments for clearance. Every country should follow the June 2011 resolution of the Customs Cooperation Council and the relevant principles of the SAFE framework of standards on the role of Customs in facilitating the clearance of relief consignments. Every country must have regulations in place (i.e. handling of cargo [emergency relief consignments] in customs area regulation) to handle the movement of cargo and personnel during the emergency relief situation. Established legal regulations and frequent training and coordination among border agencies will also help the countries hit by disaster to respond immediately without panic.

All customs administrations should have a fast-track clearance mechanism to clear relief cargoes during an emergency. For example:

1. Special berthing of vessels carrying relief cargo without queuing
2. Separate stacking of relief containers in the port terminals
3. Customs formalities to be fast-tracked before the arrival of vessels: simplified filing and easy declarations, clear policy guidelines related to tariff, import/export restrictions, facilities for deferment of duty in case of dutiable relief consignments, examination only in exceptional situations
4. Direct port delivery of cargo
5. Logistic prioritisation, emergency clearance of containers from port to destination with private sector participation (prior agreements with private logistics partners through corporate social responsibility)
6. Government legislation to control cost escalation by critical partners involved in handling of relief cargo and personnel movement (as local partners are critical to success of any emergency situation).

The role of trade in recovery and reconstruction of countries in the aftermath of a disaster is very important. Revival of trade in the affected area will stimulate growth. Hence, continuous cooperation between Customs and other border agencies would play a vital role in bringing the country's economy back on track.

## Teaming up

WCO supports Customs modernisation initiatives at national, sub-regional, regional and global levels by teaming up with other international organisations. This paper does not intend to enumerate all such WCO partnerships but highlights a few emerging paradigms in this regard.

By supporting trade facilitation, the WCO supports the work of the WTO. Post-WTO trade facilitation negotiations, a growing number of WCO partnerships are aimed at achieving economic prosperity of the people through trade facilitation, especially in least developed countries, small island economies and developing countries that require technology, capacity building, and technical support in order to comply with modern international trade regimes. Rather than following a one-size-fits-all approach, the emerging paradigm in the WCO's technical assistance appears to be tailor-made plans of technical assistance to fill the identified gaps, with single-source or multi-source financial support from other organisations. WCO's Small Island Economies Initiative (2018), which aims at dedicated support to customs administrations in small island economies, and its Global Trade Facilitation Programme (GTFP) for select beneficial countries, illustrate this paradigm.

At sub-regional and regional levels, the WCO has done commendable work in easing the transit regime to improve third country trade via ports and land ports through partnerships with regional and international organisations.<sup>21</sup> Each regional transit scheme involving member countries should be further strengthened by direct participation of the WCO through diagnostic missions and tailor-made plans by teaming up with the organisations sharing common objectives.

A novel paradigm in teaming up is WCO's encouragement of customs administrations to engage with micro, small and medium enterprises (MSMEs). MSMEs are allotted separate and unique tariff codes by customs administrations to promote their export competitiveness (Government of India, 2019). ITC-WCO Rules of Origin Facilitator, launched in 2018, was developed by the partnership of the WCO and the International Trade Centre (ITC) to help MSMEs to benefit from duty savings under preferential trade arrangements (WCO, 2018). WCO also makes trade facilitation work for MSMEs through encouragement of the AEO programme for faster clearance.

## Conclusion

Of the evolution of customs cooperation traced in this paper, two parallel strands emerge almost in tandem: one strand shows the evolution of technical cooperation and the other relates to cooperation in operational issues. As significant strides have already been made by the sustained efforts of the WCO in technical cooperation, the emerging paradigms in customs cooperation appears to centre towards operational issues.

There is a clear need for customs administrations to cooperate more proactively. The WCO has done a great deal in developing excellent international standards on different processes related to Customs and it supports compliance with those standards through technical support.

As the evolution of customs cooperation has passed through stages such as standardisation and harmonisation, simplification of customs procedures, and trade facilitation, the future of customs cooperation would lie in prescribing methods and practices for addressing and reducing vulnerability of cross-border supply chains to risks and shocks caused by man-made and natural factors. In this context, the potential of Globally Networked Customs for early response to emerging risks is to be explored as it provides the possibility for cooperation on a real-time basis to mitigate cross-border challenges before they arise.

Perhaps the time has now come for the full-scale operation of GNC relating to supply chain security on select risk parameters. The risks and problems faced by member countries are no longer different. Various problems faced by member countries are reflected by the risks and problems associated with compliance and the level of enforcement of regulatory requirements by Customs during movement of goods and persons across international borders. It is only a matter of time for pro-active cooperation among the customs community and the enormity of resources applied by customs administrations illustrates and recognises these risks and problems. Thus, GNC must evolve from mere networking and sharing of information towards preventing and mitigating the damage to the people, planet and prosperity.

## References

- Asakura, H. (2003). *World history of customs and tariffs*. World Customs Organization.
- Cottier, M., Crawford, M. H., Crowther, C. V., Ferrary, J. L., Levick, B. M., Salomies, O., & Worrle, M. (Eds). (2008). *The customs law of Asia: Oxford Studies in ancient documents*. Oxford University Press.
- De Pagter, H., & Van Raan, R. (1981). *The valuation of goods for customs purposes*. Translated by I. W. Reintjes. Springer Science+Business Media, LLC.
- Geertz, C. (1963). *Peddlers and princes: Social development and economic change in two Indonesian towns*. The University of Chicago Press.
- Green Customs. (n.d.). *Why Green Customs initiative*. <https://www.greencustoms.org/why-gci>
- Government of India. (2019, November 6). *Khadi gets separate unique HS code, export to get a boost* [Press release]. <https://pib.gov.in/Pressreleaseshare.aspx?PRID=1590633>
- Malkawi, B. H. (2019). Jordan imports and tariff regimes: A revisit. *Global Trade and Customs Journal*, 14(6), 308–318.
- National Academy of Customs Indirect Taxes and Narcotics (NACIN). (2018). *A history of Indian customs and tariff*. Faridabad.
- Okazaki, Y. (2018). *Doing business and its customs-related issues: A study on the trading across borders indicators*. WCO Research Paper No. 44. [http://www.wcoomd.org/-/media/wco/public/global/pdf/topics/research/research-paper-series/44\\_doing\\_business\\_en.pdf?la=en](http://www.wcoomd.org/-/media/wco/public/global/pdf/topics/research/research-paper-series/44_doing_business_en.pdf?la=en)
- Pahre, R. (2007). *Politics and trade cooperation in the nineteenth century: The 'agreeable customs' of 1815–1914*. University of Illinois. <https://doi.org/10.1017/CBO9780511619601>
- Pires, T. (2005). *Suma Oriental 1512–1515*. vol. 2.
- Ramdass, K., & Subramanian, G. K. (2018). *The global face of Indian customs: A historical study, A history of Indian customs and tariff*. National Academy of Customs, Indirect Taxes and Narcotics (NACIN).
- Riggs, R. E., & Mykletun, I. J. (1979). *Beyond functionalism: Attitudes toward international organization in Norway and the United States*. Published simultaneously in Norway by Universitetsforlaget and in USA by University of Minnesota Press.
- van de Ven, H. (2014). *Breaking with the past: The Maritime Customs Service and the global origins of modernity in China*. Columbia University Press.
- World Customs Organization (WCO). (2010, April 13). *Looking back, looking forward*. [Brochure]. [http://www.wcoomd.org/-/media/wco/public/global/pdf/topics/valuation/resources/brochures/omd\\_valeur\\_30ans\\_brochure\\_en\\_v4.pdf?la=en](http://www.wcoomd.org/-/media/wco/public/global/pdf/topics/valuation/resources/brochures/omd_valeur_30ans_brochure_en_v4.pdf?la=en)
- World Customs Organization (WCO). (2011, March 7). *Visit to India as part of the WCO Revenue Package programme*. <http://www.wcoomd.org/en/media/newsroom/2011/march/visit-to-india-as-part-of-the-wco-revenue-package-programme.aspx>

- World Customs Organization (WCO). (2011, July 26). *India prepared for AEO program launch supported by Globally Networked Customs*. <http://www.wcoomd.org/en/media/newsroom/2011/july/india-prepared-for-aeo-program-launch-supported-by-globally-networked-customs.aspx>
- World Customs Organization (WCO). (2018, June 28). *MSMEs to benefit from ITC-WCO Rules of Origin Facilitator*. <http://www.wcoomd.org/en/media/newsroom/2018/june/msmes-to-benefit-from-itc-wco-rules-of-origin-facilitator.aspx>
- World Customs Organization (WCO). (2020, February). *WCO News No. 21*.
- World Customs Organization (WCO). (n.d.a). *Overview and challenges*. <http://www.wcoomd.org/en/topics/origin/overview/challenges.aspx>
- World Customs Organization (WCO). (n.d.b). *List of instruments of the Customs Valuation Technical Committee*. <http://www.wcoomd.org/en/topics/valuation/instruments-and-tools/advisory-opinions.aspx>
- World Trade Organization (WTO). (n.d.c). *Implementation progress by measure*. <https://tfadatabase.org/implementation/progress-by-measure>

## Notes

- 1 As Mario Pei, in his *Language of Taxation* puts it ‘The terminology of taxation varies from period to period and from country to country.’ However, unlike other forms of ancient taxation such as land tax, the etymological history of technical names representing Customs in different language families (for example Douane, Telos, Zoll, Shulka, Chugai, Tariffa etc.) show relative permanence through centuries as well as diffusion into adjoining regions/language families. Diffusion of Customs terminology into adjoining language families provides the etymological evidence for harmonisation. Customs terminologies are immortalised through centuries by cross-border trade peer groups. Linguistic studies proves that the mercantile world has a dialect of its own and the dialect has transcended the boundaries of languages and regions.
- 2 Kautilya’s Arthashastra, Translated by Dr.R. Shamasastri with an introductory note by Dr. J.F. Fleet, p.125, Wesleyan Mission Press, Mysore, 1929. The Kautiliya Arthashastra, Part II An English Translation with Critical and Explanatory Notes, R.P. Kangle, p.146, Motilal Banarsidass Publishers Private Limited, Delhi, Second Edition: Bombay University, 1972.
- 3 ‘As regards the sale of the king’s merchandise in foreign countries:- Having ascertained the value of local produce as compared with that of foreign produce that can be obtained in barter, the Superintendent of Trade will find out (by calculation) whether there is any margin left for profit after meeting the payments (to the foreign king) such as the duty (*Śulka*), road-cess (*vantani*), conveyance-cess (*átiváhika*), tax payable at military stations (*gulmadeya*), ferry-charges (*taradeya*), subsistence to the merchant and his followers (*bhákta*), and the portion of merchandise payable to the foreign king (*bhága*).’ Kautilya’s Arthashastra, Translated by Dr.R. Shamasastri with an introductory note by Dr. J.F. Fleet, Wesleyan Mission Press, Mysore, 1929.
- 4 Chinese texts describing or referring to the Chola Kingdom as Zhu-nian, Noboru Karashima and Tansen Sen in Nagapattinam to Suvarnadwipa, Institute of SouthEast Asian Studies, Singapore, 2009.
- 5 The supply chain started from Muciri in the Malabar Coast in India to the Red Sea, then to Coptos and then across the Nile to Alexandria in the Mediterranean Coast.
- 6 The Arthashastra of Chanakya (4th Century B.C) and Suma Oriental of Tom Pires. Also see ‘Looking Back Looking Forward’ Brochure, WCO-30th Anniversary of the GATT / WTO Valuation Agreement.
- 7 CCC is established by the Convention of 15-12-1950, which is accepted by 183 countries. By CCC, we are referring to the representatives of customs administrations who meet at the Council as well as the WCO secretariat.
- 8 National Archives of India. Archives on the discussions relating to autonomous action on the part of Governments in tariff matters and unification of Customs nomenclature. Digitized documents-Identifiers: PR\_000003020570 and PR\_000003020569 (Archives relating to League of Nations Sixteenth Session Brief for the Indian Delegation), PR\_000003008471 and PR\_000003008937 (Archives relating to World Economic Conference held at Geneva in May 1927).
- 9 Draft League of Nations Uniform Customs Nomenclature (UCN) as mentioned in Indian Tariff Act 1934, US International Trade Commission’s Draft Report on the formulation of International Commodity Code (ICC), United Nations Standard International Trade Classification (SITC), Customs Cooperation Council’s Brussels Tariff Nomenclature (BTN).
- 10 ‘There is a close link between the development by the Customs Cooperation Council of the ‘harmonized system’ and the multilateral trade negotiations (MTN) which are currently taking place in Geneva. It is generally agreed that Non-Tariff Barriers will be an important element in the MTN, and tariff nomenclatures have already been identified as a major area for discussion in this context.’ Aide Memoire to the US International Trade Commission by Raymond Phan Van Phi, Commission Director in Charge of GATT Affairs, and Henry Chumas, the European Commission’s Chief Adviser on Tariffs

in the administration of the Customs Union. May 15, 1975.

- 11 WCO Press Release-Celebrating 30 years of Customs valuation, Brussels, 13 April 2010. Article 18 of the Agreement on the Implementation of Article VII of the GATT 1994 provides, ‘Technical Committee on Customs Valuation (referred to in this Agreement as ‘the Technical Committee’) under the auspices of the Customs Co-operation Council (referred to in this Agreement as ‘the CCC’), which shall carry out the responsibilities described in Annex II to this Agreement and shall operate in accordance with the rules of procedure contained therein.’
- 12 Report by Chairman of the Valuation Committee, J Alvarez (Spain) in the 25th Anniversary Sessions of the Customs Cooperation Council in Brussels from June 12 to 16, 1978, under the chairmanship of J Broz (Czechoslovakia).
- 13 ‘A change in the rate of import duty is clearly visible, while an increase in the rate of duty as a result of changes in the system of valuation is considerably less noticeable and more difficult to prove’ (de Pagter & Van Raan, 1981).
- 14 Article 18 of the Agreement on Implementation of Article VII of the GATT 1994. Also see, ‘The functioning of this Committee is under the direct control of the Council but is also responsible and subject to the GATT’. p.34, The international activities of the US Customs Service, 1984.
- 15 WCO Workshop on Customs Valuation held in Cambodia, 04 March 2020 (<http://www.wcoomd.org/en/media/newsroom/2020/march/wco-workshop-on-customs-valuation-held-in-cambodia.aspx>), Training workshop on Customs Valuation for Haitian and Dominican Republic Customs, 10 March 2020 (<http://www.wcoomd.org/en/media/newsroom/2020/march/training-workshop-on-customs-valuation-for-haitian-and-dominican-republic-customs.aspx>)
- 16 Customs Cooperation Council adopted the working name World Customs Organisation (WCO) in 1994. In 1994, the Agreement on implementation of Article VII of the GATT provided for Technical Committee on Customs Valuation under the auspices of the CCC. Also, in 1994, the Agreement on Rules of Origin was incorporated in the Uruguay Round of GATT Multilateral Trade Negotiations.
- 17 Speech by the Financial Secretary moving the Second Reading of the Appropriation Bill 1997, ‘Continuity in a Time of Change’, Hong Kong, The 1997-98 Budget, p. 8.
- 18 Fiscal Year 2012 Budget Justification: State, Foreign Operations, and Related Programs Appropriations for 2012, Part 1, Department of State, United States of America, p. 620.
- 19 Shri M. Ajith Kumar, Chairman, CBIC, Department of Revenue, Ministry of Finance, Government of India, Newsletter 14.2.2020.
- 20 A Survey of Trade Policy Issues affecting Disaster Response, Recovery and Reconstruction, World Bank Group, Geneva Office and GFDRR.
- 21 WCO works in partnership with the SSATP and IRU to promote the *Transit Guidelines* at a regional workshop on Transit for the ESA region, 28 November 2017. Also see South Asia Subregional Economic Cooperation (SASEC) Trade Facilitation Strategic Framework 2014–2018.

### MM Parthiban



MM Parthiban joined the Indian Revenue Service (Customs & Central Excise) in 1990 and is Principal Commissioner of Customs. He worked as Director (Customs) in CBIC, Ministry of Finance, New Delhi and was responsible for formulation of policy concerning administration of customs laws, tariff and procedures, including trade facilitation. As Principal Commissioner, he is responsible for all Customs vigilance enforcement matters covered under general administration of Chennai Customs Preventive Commissionerate, GST and Central Tax field formations in the States of Tamil Nadu and Kerala. In recognition of his contribution in the field of Customs, he was awarded the WCO Certificate of Merit in 2010.

### T Samaya Murali



T Samaya Murali joined the Indian Revenue Service in 2008 and is Joint Commissioner. He has experience in the fields of preventive detention, prosecution intelligence collection and the investigation of Customs-related issues. He has worked in the Special Intelligence & Investigation Branch of three major ports of India (Kandla, Mundra and Chennai) and has participated in a number of WCO training programs. He was awarded a Certificate of Appreciation in recognition of his exemplary and commendable work in the areas relating to WCO's 'Smart Borders for Seamless trade, travel & transport' theme on World Customs day, 2019.

### G Kanaga Subramanian



G Kanaga Subramanian joined the Indian Revenue Service in 2016 and is an Assistant Commissioner. He is an author with expertise in the history and evolution of customs, tariff and trade facilitation. He contributed as an author and student editor to *A history of Indian customs and tariff* (2018) by the National Academy of Customs, Indirect Taxes and Narcotics (NACIN), Faridabad. He also served on the editorial team of *Sunkam: The heritage of Chennai Customs* (2019) by the Chennai Custom House. He is currently researching Kalinga Customs and the history of customs and trade cooperation in Asia.

# Effectiveness and efficiency of artificial intelligence in boosting customs performance: a case study of RECTS at Uganda Customs administration

*Kugonza Julius and Mugalula Christabel*

## Abstract

---

The artificial intelligence (AI) revolution has great economic potential for customs operations. Indeed, some have already hailed AI ‘the new oil’ since it has become a resource for businesses to streamline processes. This may be an imperfect analogy, but it does capture the excitement and high expectations surrounding the AI-driven economy.

AI is a sub-field of computer science that enables intelligence exhibited by machines. For example, in the East African community, the Regional Electronic Cargo Tracking System (RECTS) is used to monitor cargo in transit from Mombasa in Kenya through Uganda to Rwanda and now in the Democratic Republic of Congo (DRC). This has transformed transit cargo management through deterring of dumping and diversion of transit cargo in real time. Previously, cargo would sometimes, if not most of the time, go unaccounted for while in transit, which caused government revenue leakage and business losses.

This paper examines the global standards and actions in the uptake of AI for trade facilitation in smoothing customs operations. This study looks at how the uptake of AI has affected customs administration in terms of transit management and security of cargo as well as trade facilitation, which greatly reduces the cost of doing business by the private sector.

Based on the study findings, the paper offers several recommendations for policy makers, including undertaking Private Public Partnerships (PPP), integration of RECTS with other Customs systems, well-planned change management and developing a pool of AI experts in Customs.

---

# 1. Introduction

## 1.1 Background

Artificial intelligence (AI) traditionally refers to an artificial creation of human-like intelligence that can learn, reason, plan, perceive or process natural language (Internet Society, 2017). Artificial intelligence is not one specific technology, but rather a broad spectrum of computer systems and applications that have the ability to perform tasks associated with human intelligence (Hulko, 2018). Artificial intelligence is devoted to making machines intelligent, and intelligence is that quality that enables an entity to function appropriately and with foresight in its environment (Nilsson, 2010).

The AI revolution has great economic potential globally. Indeed, some have already hailed AI ‘the new oil’ since it has become a resource for businesses to streamline processes to help us personally achieve more than we currently do, by augmenting our individual cognitive ability with new tools to increase our own productivity. This may be an imperfect analogy, but it does capture the excitement and high expectations surrounding the AI-driven economy. It is projected that the worldwide market for AI solutions could be worth more than GBP£30 billion by 2024, boosting productivity by up to 30 per cent in some industries, and generating savings of up to 25 per cent (PBLINK, 2018). In another estimate, ‘AI could contribute up to USD\$15.7 trillion to the global economy in 2030, more than the current output of China and India combined. Of this, \$6.6 trillion is likely to come from increased productivity and \$9.1 trillion is likely to come from consumption-side effects’ (Hall & Pesenti, 2017, p. 10).

Customs business is not exceptional to the AI revolution. Customs processes urgently require an AI intervention given that they are of critical interest to governments due to their trade and national security significance. The current manual processes overseeing the majority of customs operations can easily miss risky trade and declaration profiles potentially putting nations and their trade apparatus at huge risk (Kumar, 2019). The large amounts of sophisticated information that flow across borders require AI systems to read texts at a high speed, recognise relevant terms, interpret the context and draw conclusions from it. This will help customs administrations realise their strategic objectives, that is, a smarter way of securing borders, protecting society, ensuring full payment of taxes, and strengthening economic competitiveness.

AI in customs operations includes the use of machine learning, neural networks, natural language processing (NLP), and deep learning among others which helps to create intelligent machines that work and react like humans, but with higher accuracy and efficiency. An example of intelligent AI-powered customs innovations in East Africa is the Regional Electronic Cargo Tracking System (RECTS) hosted in the regional customs administrations of Uganda, Kenya, Rwanda and the Democratic Republic of Congo (DRC). These customs administrations use this single platform, which enables them to have a single watch and view of cargo during its movement along the northern corridor. Only one seal is used, which removes the need for arming and disarming the e-seals at partner states’ territorial borders.

RECTS operates in real time through neural networks, a branch of AI. This enables the AI-powered system to make use of the Global Positioning System (GPS), a satellite-based navigation system that provides reliable real-time transit data coordinates on the positioning and navigation of transits along the northern corridor. The positioning transit data is then analysed through algorithms embedded in machine learning, a subset of AI, and the results are then used alongside the gazetted geofenced route coordinates to detect any transit violations, such as going off-route, seal tampering or breaking at any of the customs central command centres in the partner states.



Figure 1 below illustrates trucks armed with e-seals on the northern corridor from Mombasa Port destined to Kenya, Uganda, Rwanda, South Sudan and DRC. Yellow and red truck images show trucks carrying both imports and exports, respectively, that are on the agreed predestined route with e-seals intact. The triangular red exclamation marks indicate hot spots with a previous history of fraud and tampering of e-seals on trucks which require urgent customs intervention through the Rapid Response Units within the respective partner states since the e-seals are tampered with.

*Figure 1: Illustration of trucks armed with e-seals along the Northern Corridor*

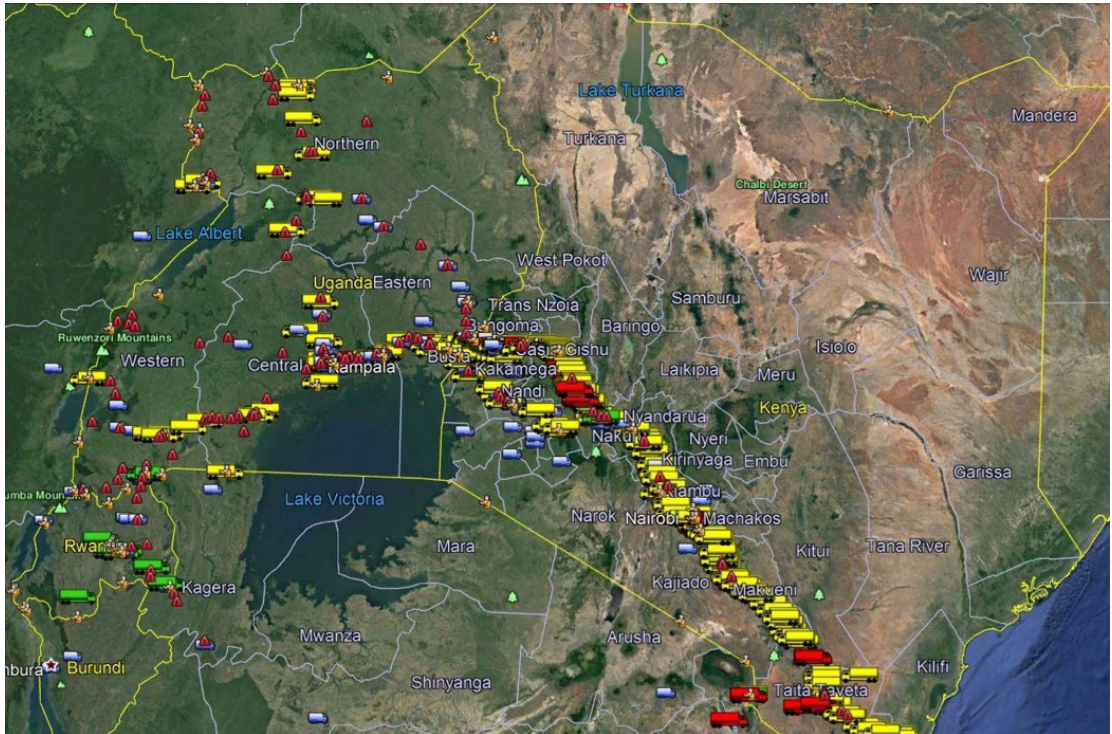

Source: URA Central Command Center 2020

## 1.2 Problem statement

The cargo transit operations across the five land-linked developing countries of Uganda, Rwanda, Burundi, the DRC and South Sudan involved, for a long time, a convoy system, characterised by paper-based controls, transit log sheets, physical escorts, and transit check points (Balamaga, 2019). Balamaga (2019) further asserted that this transit system was overwhelmed by various impediments to the seamless flow of cargo that included, among others, unnecessary delays, a high cost of doing business, non-tariff barriers, transit diversion, high administrative monitoring costs, and information-sharing gaps between the partner states.

Raballand (2012) added that as the private sector does not seem to have an interest in reducing dwell time in Sub-Saharan Africa, the interests of controlling agencies like Customs collude at the expense of traders. This is further worsened by the transit cargo theft problem, which has intensified in the past decade due to the increased value of cargo.

## 2. Global standards and actions in the uptake of AI

Standards, particularly those developed by existing international standards bodies, can support the global governance of AI-powered solutions like RECTS development and play an important role in facilitating the adoption of new technologies in customs administrations. Mandatory minimum standards are set to ensure AI-powered solutions meet a threshold for product performance and/or safety and to avoid undue risks for consumers. Some of the global standards that were taken into account when developing RECTS are set out below.

### 2.1. Adherence to existing human rights frameworks

Human rights are the foundation of human existence and coexistence. Human rights norms provide a framework for equality and non-discrimination that, when objectively applied, ensures that the benefits of human development reach even the most disadvantaged people. AI systems should therefore be designed in a way that respects the rule of law, human rights, democratic values and diversity, and they should include appropriate safeguards—for example, enabling human intervention where necessary—to ensure a fair and just society (OECD, 2019a). AI actors should respect the rule of law, human rights and democratic values, throughout the AI system lifecycle. These include freedom, dignity and autonomy, privacy and data protection, non-discrimination and equality, diversity, fairness, social justice, and internationally recognised labor rights (G20, 2019).

As customs administrations adopt AI to promote the seamless movement of goods through secure international trade supply chains, the development process of AI systems should ensure that AI should not be used to diminish the data rights or privacy of individuals, families or communities (UK Government, 2019). The General Data Protection Regulation ensures a high standard of protection of personal data and requires the implementation of measures to ensure data protection by design and by default (Regulation (EU) 2016/679).

### 2.2. Inclusive growth, sustainable development, and wellbeing

AI has the potential to improve the welfare and wellbeing of people, to contribute to positive sustainable global economic activity, to increase innovation and productivity, and to help respond to key global challenges (OECD, 2019b). AI systems should support individuals in making better, more informed choices in accordance with their goals. They should act as enablers to a flourishing and equitable society by supporting human agency and fundamental rights, and not decrease, limit or misguide human autonomy. The overall wellbeing of the user should be central to the system's functionality; AI is not an end in itself, but a tool that has to serve people with the ultimate aim of increasing human wellbeing (European Commission, 2019).

Stakeholders should proactively engage in responsible stewardship of trustworthy AI in pursuit of beneficial outcomes for people and the planet, such as augmenting human capabilities and enhancing creativity, advancing inclusion of underrepresented populations, reducing economic, social, gender and other inequalities, and protecting natural environments, thus invigorating inclusive growth, sustainable development and wellbeing (OECD, 2019b; G20, 2019).

### 2.3. Ensuring accountable and responsible design

The automation of customs procedures is an important part of reform and modernisation efforts, as automated systems are one of the main integrity controls within customs administrations. AI can facilitate audits and reviews of decisions by customs officials, and automation of a wide range of processes can be used to increase transparency and accountability in customs administrations (OECD, 2016). AI systems

should therefore be held accountable for their proper functioning in line with the above principles. Mechanisms should be put in place to ensure responsibility and accountability for AI systems and their outcomes, both before and after their implementation. The audit ability of AI systems is key in this regard, as the assessment of AI systems by internal and external auditors, and the availability of such evaluation reports, strongly contributes to the trustworthiness of the technology. External auditability should especially be ensured in applications affecting fundamental rights, including safety-critical applications (European Commission, 2019).

Potential negative impacts of AI systems should be identified, assessed, documented and minimised. The use of impact assessments facilitates this process. These assessments should be proportionate to the extent of the risks that the AI systems pose. Trade-offs between the requirements, which are often unavoidable, should be addressed in a rational and methodological manner, and should be accounted for. Finally, when unjust adverse impacts occur, accessible mechanisms should ensure adequate redress (European Commission, 2019).

AI actors should be accountable for the proper functioning of AI systems and for the respect of the above principles, based on their roles, the context, and consistent with the state of art practices (G20, 2019).

## **2.4 Transparent technology**

Transparency and predictability of regulations and procedures at borders are widely recognised as essential elements of trade facilitation.<sup>1</sup> Transparency and predictability are the starting point for ensuring the efficiency and, ultimately, the stability of a rules-based environment for goods crossing the border (WCO, 2017). The trustworthiness of AI systems is likewise a key factor for the diffusion and adoption of AI, and a well-informed whole-of-society public debate is necessary for capturing the beneficial potential of the technology, while limiting the risks associated with it (OECD, 2019b). There should be transparency and predictability around AI systems to ensure that people understand AI-based outcomes and can challenge them.

AI actors should also commit to transparency and predictability regarding AI systems. They should provide meaningful information, appropriate to the context, and foster a general understanding of AI systems, to make stakeholders aware of their interactions with AI systems, including in the workplace. They should also enable those affected by an AI system to understand the outcome and enable those adversely affected by an AI system to challenge its outcome based on plain and easy-to-understand information on the factors, and the logic that served as the basis for the prediction, recommendation or decision (G20, 2019). Also, all citizens have the right to be educated to enable them to flourish mentally, emotionally and economically alongside AI (International Telecommunication Union, 2018).

These principles are supported by Chapter 9 of the General Annex of the Revised Kyoto Convention (RKC) (Information, Decisions and Rulings supplied by Customs), which contains numerous standards regarding transparency and predictability. The WCO (2017) *Transparency and predictability guidelines* also highlight the importance of transparency and includes a checklist on this matter.

## **2.5 Privacy and data governance**

Customs administrations should ensure that confidential or commercially sensitive information is not divulged (WCO, 2017) unless such disclosure is required or authorised by national legislation.

Privacy and data protection must therefore be guaranteed at all stages of the AI system's life cycle. Digital records of human behaviour may allow AI systems to infer not only an individual's preferences, age and gender, but also such things as their sexual orientation and religious or political views. To allow individuals to trust the data processing, it must be ensured that they have full control over their own

data, and that data concerning them will not be used to harm or discriminate against them. In addition to safeguarding privacy and personal data, requirements must be fulfilled to ensure high-quality AI systems.

The quality of the datasets used is paramount to the performance of AI systems. When data is gathered, it may reflect socially constructed biases, or contain inaccuracies, errors and mistakes. This needs to be addressed prior to training an AI system with any given dataset. In addition, the integrity of the data must be ensured. Processes and datasets used must be tested and documented at each step such as planning, training, testing and deployment. This should also apply to AI systems that were not developed in-house but acquired elsewhere. Finally, access to data must be adequately governed and controlled (European Commission, 2019).

## **2.6 Robustness, security and safety**

The WCO security initiative is to facilitate members' activities to implement measures—whether standards, guidance, IT tools, operations or specialised training—to enhance border security and management capacities in a holistic manner. AI systems should therefore be robust, secure and safe throughout their lifecycle so that, in conditions of normal use, foreseeable use or misuse, or other adverse conditions, they function appropriately and do not pose unreasonable safety risks. AI actors should also ensure traceability, including in relation to datasets, processes and decisions made during the AI system lifecycle, to enable analysis of the AI system's outcomes and responses to inquiry, appropriate to the context. Further, AI actors should, based on their roles, the context, and their ability to act, apply a systematic risk management approach to each phase of the AI system lifecycle on a continuous basis to address risks related to AI systems, including privacy, digital security, safety and bias.

## **2.7 Diversity, non-discrimination and fairness**

Datasets used by AI systems (both for training and operation) may suffer from the inclusion of inadvertent historic bias, incompleteness and bad governance models. The continuation of such biases could lead to (in)direct discrimination. Harm can also result from the intentional exploitation of (consumer) biases or by engaging in unfair competition. Moreover, the way in which AI systems are developed (for example, the way in which the programming code of an algorithm is written) may also suffer from bias. Such concerns should be tackled from the beginning of the system's development. Establishing diverse design teams and setting up mechanisms ensuring participation, in particular of citizens, in AI development can also help to address these concerns. It is advisable to consult stakeholders who may directly or indirectly be affected by the system throughout its lifecycle. AI systems should consider the whole range of human abilities, skills and requirements, and ensure accessibility through a universal design approach to strive to achieve equal access for persons with disabilities.

# **3. Challenges in the uptake of AI in customs operations**

In this section we identify the main challenges that may be experienced for the uptake of AI-powered solutions like RECTS in customs operations.

## **3.1 Change management over anticipated job loss**

Change is a transition from one state to another with a focus on being different. Managing change *is* tough, but part of the problem is that there is little agreement on which factors most influence transformation initiatives. Ramosaj et al. (2014) showed that changes that are happening in businesses dictate the changes in all kinds of needed resources thereafter. They further discuss that managing AI changes may therefore be a challenge that administrations are likely to face because employees may

have negative attitudes towards them, especially those who have become used to operating in the same way over a long period of time. They also argue that this may be related to the fear of job losses and/or a reduction in income.

Galbraith (2018) highlights the uncertainty created when management does not communicate well, which disrupts work and makes employees feel as if they are not a part of the decision. This may be worsened by the fact that employees dislike change unless it is one that they have requested or lobbied for hence their involvement during the transition. Galbraith also points out that employees need to understand which duties and responsibilities will continue as normal and which ones will change. As far as indirect changes are concerned, employees need to be aware of the changes occurring throughout the organisation and how they may impact their job function.

### **3.2 Skills gap and a shortage of AI researchers**

Despite the fast growth of AI technology, few countries—including developed countries—have the education and skills systems in place to equip their workers to reap the benefits of AI (Access Partnership, n.d.). Importantly, skills shortages foster growing competition, as companies and institutions vie to attract and retain talent, a trend that is affecting both the domestic and international labour markets (UNESCO, 2019). This argument is supported by survey results in New Zealand showing that 44 per cent of survey respondents considered education a key barrier to AI adoption. The report further pointed out that traditional education providers are not yet providing the skills and training required to develop AI excellence in New Zealand (AI Forum of New Zealand, 2018).

Attracting leading AI researchers will be challenging due to growing global demand for AI talent. Therefore, it is essential that Customs, through the WCO, actively competes for talent or risks becoming merely a downstream consumer of AI research from other countries.

### **3.3 Capital investments in AI research and development needed**

While the benefits of digitalisation may be clear, in the short term the transition usually increases costs and the gains may take some years to materialise, and this kind of spend can be politically hard to justify (ICEAW, 2019). A company venturing in AI solutions should objectively assess the level of research and development it can bear both psychologically and financially (Slesar, 2019).

Davenport (2020) notes that the key driver of lack of return from AI is the simple failure to invest sufficiently. Fabian (2017) also notes that as assessing AI technologies is challenging, many investors are hesitant to invest because most venture capital firms are risk-averse and do not invest in something they do not understand. He further adds that many AI companies receive plenty of attention but not enough funding.

### **3.4 AI legislation and regulation**

The European Union (EU, 2019) reported that, to build trust for the usage, adoption and development of AI across society, the UK government is putting in place governance regimes for data-driven AI. This includes the development of ethical guidelines for a sustainable, transparent, replicable use of AI with clear definitions on responsibilities, liabilities, and data protection issues.

In 2017, Elon Musk pointed out the need for caution when implementing AI because there should be some regulatory oversight of AI at the national and international level (Vincent, 2017). His view was also supplemented by Oxford philosopher Nick Bostrom who believed that just as humans out-competed and almost completely eliminated gorillas, AI will outpace human development and ultimately dominate and therefore needs to be regulated (Etzioni & Etzioni, 2017).

Without a proper legal basis for the collection of information, the use of electronic data as evidence and the requirement for data to be supplied in a given format, taxpayers will lack the certainty they need to plan their compliance activities and may resist or refuse to comply with the authority's requests (ICAEW, 2019). Importantly, legally, organisations must obtain consent to collect, use and disclose an individual's personal information, subject to a list of specific exceptions, and obtaining meaningful consent has become increasingly challenging in the age of big data, the Internet of Things, artificial intelligence and robotics (Office of the Privacy Commissioner of Canada, 2017).

### 3.5 Better national coordination required geographically

The AI Forum of New Zealand (2018) reported that New Zealand, a small country with limited resources, should consider a coordinated national approach to AI research. The findings of the research pointed towards the Canadian AI strategy as a model to emulate.

One of the key priorities of the European Commission's Coordinated Plan on AI is to encourage member states to develop their national AI strategies by the end of 2019, outlining investment levels and implementation measures.

### 3.6 Limited infrastructure

The Swedish strategy emphasises the need for a digital infrastructure to harness the opportunities that AI can provide, including both a high-quality data infrastructure and a well-developed digital and telecommunication infrastructure in terms of computer power, connectivity and network capacity (Government Offices of Sweden, 2018).

A lack of data infrastructure and the inability to effectively analyse vast swathes of intelligence are among the challenges that are forcing global manufacturing firms to rethink their AI implementation projects (*The Manufacturer*, 2020).

## 4. Regional electronic cargo tracking system case study in Uganda

### 4.1 Background

Customs transit involves permitting goods to move under customs control from one customs office to another in the same customs territory or another customs territory, without collecting duties and taxes and without applying economic prohibitions or restrictions, or other commercial policy measures (WCO, 2014). A functional transit system is essential for trade connectivity within the region, particularly for landlocked countries where most of their trade is with countries outside the region and moves in transit through their neighbouring countries (Yasui, 2013).

Transit inefficiency is a result of a variety of factors, such as inadequate interconnection of the existing customs management systems across countries, inadequate transit traffic monitoring and enforcement capabilities by customs administrations, lack of a regional transit guarantee system,<sup>2</sup> and an ineffective truck sealing system to reduce the diversion of transit goods.<sup>3</sup> To monitor and control the movement of transit goods along the corridor, customs administrations have relied on physical escorts for transit trucks. The number of checkpoints along the corridor remains a source of delays and costs for transit traffic. A poor transit system may hamper international trade and national security significantly, and thus hinder the economic development of a country.

The northern corridor links land-linked countries to the Kenyan seaport of Mombasa. Formerly, goods in transit within the region were escorted from the port of Mombasa all the way to Rwanda, South Sudan and DRC borders through Ugandan borders such as Elegu, Oraba, Padea and Goli. It is with this

background that the Electronic Cargo Tracking System (ECTS) was established in Uganda in 2014 and further expanded into a Regional Electronic Cargo Tracking System (RECTS) covering Uganda, Kenya and Rwanda in 2017, with the DRC joining RECTS in 2019.

*Table 1: Total transits in Uganda 2014–2018*

	2014	2015	2016	2017	2018
<b>Total transits</b>	178,090	195,372	189,618	233,922	285,824
<b>e-monitored</b>	11,459	17,226	15,094	42,845	60,066
<b>% of e-monitored</b>	6.43%	8.82%	7.96%	18.32%	21.02%

*Source:* URA databases

Table 1 shows an increase in the e-monitored cargo from 6.43 per cent in 2014 to 21.02 per cent in 2018. The RECTS process starts when a customs officer attaches an electronic seal (e-seal) or ultra-sub-sensors on a transit goods container and activates the seal in the system. Upon arrival at its destination without any violations, a customs officer deactivates the seal. The tracking of transit cargo is a crucial customs enforcement practice to monitor and enforce pre-scheduled rules and generate precise information about the position of transit goods at all times. Dysfunctional custom transit procedures increase transportation costs and constitute a major obstacle to international trade.

## 4.2 Methodology

This study looked at 40 different transits from Malaba to Kampala over 220 kilometres. The transits included transits with e-seals, transits escorted by physical security and transits with normal seals. The different transit times were used to analyse the differences among the three group means in a sample so as to determine the influence of using AI in the management of Uganda's transit system.

The analysis of variance (ANOVA) is based on the law of total variance, where the observed variance in a particular variable is partitioned into components attributable to different sources of variation.

## 4.3 Findings

Table 2 shows the average transit time for the normal seals to be 12.10 hours and the average transit time for e-seal transits to be 8.7 hours over the same distance. The average transit time for escorted transits is 12.4 hours. The average transit time for e-seal transits is lower mainly because these transits are monitored using AI in real time from the time of departure to the time of arrival and therefore with no unnecessary stopovers, such as interventions by mobile rapid response teams. The average transit time for escorted transits is higher because these transits are at a driver's convenience, which is one form of inefficiency because the longer a truck spends in transit, the higher the transportation costs a trader is charged. Sometimes escorted trucks are also delayed while waiting for the physical escorts who may be unavailable.

Table 2: Transit times

	N	Mean (hours)	Standard Deviation	Standard Error	95% Confidence Interval for Mean	
					Lower Bound	Upper Bound
<b>Normal seal transit</b>	16	12.1044	1.76266	.44067	11.1651	13.0436
<b>e-seal transit</b>	13	8.6923	.96993	.26901	8.1062	9.2784
<b>Escorted transit</b>	11	12.4182	1.51249	.45603	11.4021	13.4343
<b>Total</b>	40	11.0818	2.21517	.35025	10.3733	11.7902

Source: URA databases

The results presented in Table 2 are further supported by the results of Table 3, which shows a P value of less than 0.05, meaning that there is a significant difference between the different average transit times of the three different transit categories.

Table 3: Analysis of variance of different transit times

	Sum of squares	df	Mean square	F	P value
<b>Between groups</b>	110.601	2	55.301	25.333	.000
<b>Within groups</b>	80.770	37	2.183		
<b>Total</b>	191.372	39			

Source: URA databases. df, degrees of freedom. F, F value.

Table 4 uses the Tukey’s HSD test and, based on the results presented in Table 3, the Tukey’s test shows that there is a significant difference particularly in average transit times of e-seal transits that utilise AI compared to other transits at a 5 per cent level of significance.



Table 4: Multiple comparisons of the different transit times

(I) Type	(J) Type	Mean Difference (I-J)	Std. Error	Sig.	95% Confidence Interval	
					Lower Bound	Upper Bound
Normal seal transit	e-seal transit	3.41207*	.55169	.000	2.0651	4.7590
	Escorted transit	-.31381	.57870	.851	-1.7267	1.0991
e-seal transit	Normal seal Transit	-3.41207*	.55169	.000	-4.7590	-2.0651
	Escorted transit	-3.72587*	.60529	.000	-5.2037	-2.2481
Escorted transit	Normal seal Transit	.31381	.57870	.851	-1.0991	1.7267
	e-seal transit	3.72587*	.60529	.000	2.2481	5.2037

Source: URA databases \*The mean difference is significant at the 0.05 level

The results are further supplemented by the findings of TradeMark East Africa (TradeMark East Africa, n.d.), which reported that transporters lose USD \$200–\$250 each day a truck spends while in transit which tends to increase the cost of transport for cargo destined further inland, such as Rwanda.

RECTS has minimised the need for physical escorts that previously increased transit periods from one day to three or four days, effectively resulting in an estimated increase in transport costs of about USD \$400–\$500. RECTS has also cut the time required to transport cargo from entry border points (Kenya's Malaba and Busia in Uganda) from six days to one and a half days, subsequently pushing down transport costs (TradeMark East Africa, n.d.).

The report confirms that RECTS has reduced the cost of doing business in Rwanda through improved cargo predictability and increased truck turnaround time, which ultimately leads to lower transport costs. Transport delays and cargo theft are among key concerns for importers and exporters and, with improved security of cargo, importers expect a reduction in transit risks as well as insurance premiums.

In conclusion, RECTS has improved the effectiveness and efficiency of transit management in Uganda because e-sealed transit cargo can be accounted for and traced hence potential cases of diversion or round tripping of goods are detected in real time, hence deterring dumping. It has also enhanced cargo security, which has reduced losses for the business community thereby improving the reputation of Customs.

## 5. Conclusion

Several challenges need to be addressed to introduce AI. These include factors such as change management over anticipated job loss, skills gap and shortage of AI researchers, capital investment in AI research, AI legislation and limited infrastructure—to name just a few. These challenges need to be addressed by both industry and customs administrations to unlock the significant benefits AI offers.

To achieve this, it is recommended that a Private Public Partnerships (PPP) plan be established for financing coverage infrastructure of RECTS from a few sensitive items in transit to a full roll-out of RECTS on all transit items into and through Uganda. This should be encouraged and further strengthened to increase cargo security along the northern corridor. In this regard, successful AI innovation depends on the creation of PPP connections, links between interested parties, the market, AI end users and AI research experts.

There is also a need to integrate RECTS with other customs systems like Asycuda to inform selectivity risk criteria during the processing of customs declarations. For example, in terms of diversion detection, cargo must be rerouted to the red lane for 100 per cent verification. As a region using RECTS, we should have an ambition of integrating with other smart cargo monitoring systems like Arviem, a cargo monitoring solution that creates real-time supply chain visibility from the port of loading in the country of export to the point of destination.

For other administrations intending to implement AI, a clear change management strategy should be developed by customs administrations, with a detailed action plan, including priorities, timelines, tasks, structures, behaviours, and resources to identify what has changed and what has stayed the same. This will enable staff to appreciate AI-powered solutions as enhancers to their tasks and roles rather than a potential cause of job loss.

Additionally, the WCO should spearhead the accreditation of AI experts in Customs since, despite the fast growth of AI technology, few countries—including developed countries—have the education and skills systems in place to equip their workers to reap the benefits. This will facilitate innovation among customs administrations and facilitate the development of Customs AI-powered solutions.

The WCO should also spearhead the creation of regional AI laboratories to create an enabling environment for development and adoption of AI research in Customs, which will promote Customs AI-powered solutions.

Finally, customs administrations must work co-operatively—as stipulated in the WCO SAFE Framework of Standards—with common and accepted standards to maximise facilitation of the international trade supply chain. When customs administrations are able to work together, it makes joint AI projects like RECTS in Kenya, Uganda, Rwanda and DRC possible, which has made it possible to secure a lengthy supply chain corridor between the different countries. In this regard, co-operation among customs administrations enables them to learn from each other, and benchmark and adopt best practices for AI-powered solutions as a replacement for manual processes.

## References

- Access Partnership. (n.d.). *Artificial intelligence for Africa: An opportunity for growth, development, and democratisation*. [https://www.up.ac.za/media/shared/7/ZP\\_Files/ai-for-africa.zp165664.pdf](https://www.up.ac.za/media/shared/7/ZP_Files/ai-for-africa.zp165664.pdf)
- AI Forum of New Zealand. (2018). *Artificial intelligence: Shaping a future New Zealand*. <https://www.mbie.govt.nz/dmsdocument/5754-artificial-intelligence-shaping-a-future-new-zealand-pdf>
- Davenport, T. (2020, March 27). *Return on artificial intelligence: The challenge and the opportunity*. Forbes.com. <https://www.forbes.com/sites/tomdavenport/2020/03/27/return-on-artificial-intelligence-the-challenge-and-the-opportunity/#4783b0906f7c>
- DiploFoundation. (2019). *Mapping the challenges and opportunities of artificial intelligence for the conduct of diplomacy*. Geneva: DiploFoundation. <https://www.diplomacy.edu/sites/default/files/AI-diplo-report.pdf>
- Etzioni, E., & Etzioni, O. (2017). Should artificial intelligence be regulated? *Issues in Science and Technology*, 33(4), 32–36. [https://papers.ssrn.com/sol3/papers.cfm?abstract\\_id=2993506](https://papers.ssrn.com/sol3/papers.cfm?abstract_id=2993506)
- European Commission (EC). (2019). *Communication from the Commission to the European Parliament, the Council, the European Economic and Social Committee and the Committee of the Regions: Building trust in human-centric artificial intelligence*. Brussels: EC. <https://ec.europa.eu/transparency/regdoc/rep/1/2019/EN/COM-2019-168-F1-EN-MAIN-PART-1.PDF>
- European Union. (EU) (2019). *United Kingdom AI strategy report*. Brussels: EU. [https://ec.europa.eu/knowledge4policy/node/37933\\_nl](https://ec.europa.eu/knowledge4policy/node/37933_nl)
- Fabian. (2017, September 11). *Challenges and opportunities of investing in artificial intelligence startups*. Medium.com. <https://medium.com/@bootstrappingme/challenges-and-opportunities-of-investing-in-artificial-intelligence-startups-f36889dbb592>
- G20. (2019). *G20 ministerial statement on trade and digital economy*. <https://www.mofa.go.jp/files/000486596.pdf>
- Galbraith, M. (2018, October 5). Don't just tell employees organizational changes are coming — explain why. *Harvard Business Review*. <https://hbr.org/2018/10/dont-just-tell-employees-organizational-changes-are-coming-explain-why>
- Government Offices of Sweden. (2018). *National approach to artificial intelligence*. <https://www.government.se/491fa7f/contentassets/fe2ba005fb49433587574c513a837fac/national-approach-to-artificial-intelligence.pdf>
- Hall, W., & Pesenti, J. (2017). *Growing the artificial intelligence industry in the UK*. Department for Digital, Culture, Media & Sport and Department of Business, Energy & Industrial Strategy. [https://assets.publishing.service.gov.uk/government/uploads/system/uploads/attachment\\_data/file/652097/Growing\\_the\\_artificial\\_intelligence\\_industry\\_in\\_the\\_UK.pdf](https://assets.publishing.service.gov.uk/government/uploads/system/uploads/attachment_data/file/652097/Growing_the_artificial_intelligence_industry_in_the_UK.pdf)
- Hulko, T. (2018, May 18). Will AI be a bane or boon for global development? *United Nations Development Programme Blog*. <https://www.undp.org/content/undp/en/home/blog/2018/Will-AI-be-a-bane-or-boon-for-global-development.html>
- The Institute of Chartered Accountants in England and Wales (ICAEW). (2019). *Digitalisation of tax: International perspectives*. [https://www.icaew.com/technical/technology/technology-and-the-profession/digitalisation-of-tax-international-perspectives#:~:text=Digitalisation%20of%20tax%3A%20international%20perspectives%20\(2019%20edition\),future%20challenges%20these%20economies%20face.](https://www.icaew.com/technical/technology/technology-and-the-profession/digitalisation-of-tax-international-perspectives#:~:text=Digitalisation%20of%20tax%3A%20international%20perspectives%20(2019%20edition),future%20challenges%20these%20economies%20face.)
- International Telecommunication Union (ITU). (2018, September). *Assessing the economic impact of artificial intelligence. ITUTrends: Emerging trends in ICTs*. Issue paper No. 1. Geneva: ITU. [https://www.itu.int/dms\\_pub/itu-s/opb/gen/S-GEN-ISSUEPAPER-2018-1-PDF-E.pdf](https://www.itu.int/dms_pub/itu-s/opb/gen/S-GEN-ISSUEPAPER-2018-1-PDF-E.pdf)

- Internet Society. (2017). *Artificial intelligence and machine learning: Policy paper*. [https://www.internet-society.org/resources/doc/2017/artificial-intelligence-and-machine-learning-policy-paper/?gclid=Cj0KCQiAs67yBRC7ARIsAF49CdXldZR-VFD4ClhsLbQfJ5DESX0KdQ1h3zjSBRyoYw2FT9fW0GLgrVsaAlxLEALw\\_wcB](https://www.internet-society.org/resources/doc/2017/artificial-intelligence-and-machine-learning-policy-paper/?gclid=Cj0KCQiAs67yBRC7ARIsAF49CdXldZR-VFD4ClhsLbQfJ5DESX0KdQ1h3zjSBRyoYw2FT9fW0GLgrVsaAlxLEALw_wcB)
- Nilsson, N. J. (2010). *The quest for artificial intelligence: A history of ideas and achievements*. Cambridge University Press. <https://ai.stanford.edu/~nilsson/QAI/qai.pdf>
- Office of the Privacy Commissioner of Canada. (2017, February 16). *Appearance before the Standing Committee on Access to Information, Privacy and Ethics (ETHI) on the Study of the Personal Information Protection and Electronic Documents Act (PIPEDA)*. [https://www.priv.gc.ca/en/opc-actions-and-decisions/advice-to-parliament/2017/parl\\_20170216/](https://www.priv.gc.ca/en/opc-actions-and-decisions/advice-to-parliament/2017/parl_20170216/)
- Slesar, M. (2019, December 12). Artificial intelligence in business: Meeting the challenges to AI adoption. *Onix Blog*. <https://onix-systems.com/blog/artificial-Intelligence-in-business-meeting-the-challenges-to-ai-adoption>
- Organisation for Economic Co-operation and Development (OECD). (2016). *Integrity in customs: Taking stock of good practices*. Paris: OECD. <https://www.oecd.org/corruption/ethics/G20-integrity-in-customs-taking-stock-of-good-practices.pdf>
- Organisation for Economic Co-operation and Development (OECD). (2019a). *OECD principles on AI*. Paris: OECD. <https://www.oecd.org/going-digital/ai/principles/>
- Organisation for Economic Co-operation and Development (OECD). (2019b). *Recommendation of the Council on Artificial Intelligence*. OECD Legal Instruments. Paris: OECD. <https://legalinstruments.oecd.org/en/instruments/OECD-LEGAL-0449>
- Polish Business Link (PBLINK). (2018, May 21). *PBLink Blog*. What every business needs to know about AI. <https://www.pblink.co.uk/other/every-business-needs-know-ai/>
- PWC. (2018). *The macroeconomic impact of artificial intelligence*. <https://www.pwc.co.uk/economic-services/assets/macro-economic-impact-of-ai-technical-report-feb-18.pdf>
- Ramosaj, B., Karaxha, H., & Karaxha, H. (2014). Change management and its influence in the business environment. *Iliria International Review*, 4(2), 9–30. <https://iliriapublications.org/index.php/iir/article/view/43>
- Standards Australia. (2019). *Developing standards for artificial intelligence: Hearing Australia's voice*. Discussion Paper, June 2019. [https://www.standards.org.au/getmedia/aeaa5d9e-8911-4536-8c36-76733a3950d1/Artificial-Intelligence-Discussion-Paper-\(004\).pdf.aspx](https://www.standards.org.au/getmedia/aeaa5d9e-8911-4536-8c36-76733a3950d1/Artificial-Intelligence-Discussion-Paper-(004).pdf.aspx)
- The Manufacturer. (2020, February 17). *Barriers to AI uptake among manufacturers revealed*. <https://www.themanufacturer.com/articles/barriers-ai-uptake-among-manufacturers-revealed/>
- TradeMark East Africa (TMEA). (n.d.). *Regional electronic cargo tracking system unveiled*. Nairobi: TMEA. <https://www.trademarka.com/news/regional-electronic-cargo-tracking-system-unveiled/>
- UK Government. (2019, May 21). *Policy paper: AI sector deal*. <https://www.gov.uk/government/publications/artificial-intelligence-sector-deal/ai-sector-deal#key-commitments>
- United Nations Educational, Scientific and Cultural Organization (UNESCO). (2019). *Artificial intelligence in education: Challenges and opportunities for sustainable development*. UNESCO Working Papers on Education Policy 07. Paris: UNESCO. <http://repositorio.minedu.gob.pe/bitstream/handle/MINEDU/6533/Artificial%20intelligence%20in%20education%20challenges%20and%20opportunities%20for%20sustainable%20development.pdf?sequence=1&isAllowed=y>
- Vincent, J. (2017, July 17). Elon Musk says we need to regulate AI before it becomes a danger to humanity. *theverge.com*. <https://www.theverge.com/2017/7/17/15980954/elon-musk-ai-regulation-existential-threat>

World Customs Organization (WCO). (2014). *Transit handbook to establish effective transit schemes for LLDCs*. Brussels: WCO. [https://na.eventcloud.com/file\\_uploads/054a3d043ff3d9ee58dbc5f559bf54fb\\_ENtransit-handbook-for-upload-en.pdf](https://na.eventcloud.com/file_uploads/054a3d043ff3d9ee58dbc5f559bf54fb_ENtransit-handbook-for-upload-en.pdf)

World Customs Organization (WCO). (2017). *Transparency and predictability guidelines*. Brussels: WCO. <http://www.wcoomd.org/-/media/wco/public/global/pdf/topics/facilitation/instruments-and-tools/tools/transparency-and-predictability-guidelines/transparency-guidelines.pdf?db=web>

Yasui, T. (2013). Transit facilitation for regional economic integration and competitiveness. *WCO Research Paper no. 28*. <http://www.wcoomd.org/en/topics/research/activities-and-programmes/~media/30EA73887EED41E1A3E774175C7FE097.ashx>

## Notes

- 1 The WTO Glossary defines transparency as the ‘Degree to which trade policies and practices, and the process by which they are established, are open and predictable’.
- 2 Decision C/DEC.13/01/03 Establishes a Regional Road Transport and Transit Facilitation Program in Support of Inter-Community Trade and Cross-Border Movements (JBPs, Observatories, ISRT Awareness)
- 3 Resolution No.2 relating to the implementation of the Joint Border Posts Program of ECOWAS and UEMOA member states

### Kugonza Julius



Kugonza Julius holds a master’s degree in economic policy and a bachelor’s degree in statistics from Makerere University, Uganda. He is also a trade policy design and negotiation fellow from the University of Adelaide, Australia, as well as a Mo Ibrahim Governance Fellow from SOAS-University of London. Julius has over 10 years’ experience in the public, CSO and private sectors. He currently works with Uganda Revenue Authority as a Customs Data Analyst. He has worked with Uganda Cares-AHF. He is also a part time Senior Research Fellow at Pride Data Solutions. Julius has researched international trade, food security and urbanisation in sub Saharan Africa and presented policy research papers in Italy, South Africa, Rwanda, Ethiopia, Kenya and Zambia.

### Mugalula Christabel



Mugalula Christabel is an applied macroeconomist with over a decade of experience. She holds a Bachelor of Arts Degree in economics from Makerere University, Uganda, as well as a Master of Arts in economic policy from the same institution. She is trained in competition assessment and forecasting in telecoms by PURC, University of Florida, USA, as well as pricing for profit and competitive advantage, by the International Telecommunications Union. Christabel currently works with the Uganda Revenue Authority as a Trade Specialist in Uganda Customs. She has previously worked with the Uganda Communications Commission as a Tariffs & Data Officer. She was also part of consultancies such as commercial interconnection negotiations for newly licensed operators in Tanzania, among others.



# How to connect the PICARD program to regional capacity building activities—from the perspective of the WCO Asia Pacific Region

*Tong Hua*

## Abstract

There is one WCO Regional Office for Capacity Building (ROCB) and seven Regional Training Centres (RTCs) in the Asia Pacific (A/P) region. The WCO and these regional bodies have jointly organised many capacity building activities, namely regional, sub-regional and national workshops. The topics covered align closely with those addressed at WCO PICARD conferences. The difference is that the conference is more focused on academic or theoretical aspects of the topics, while the workshops are more focused on practical ones. This article discusses how to combine these academic contributions with the work of the WCO regional structures in the future in three ways, (1), with the creation of a centre of excellence, in which ROCB and RTCs can play a more important think-tank role, (2), including the outcomes of the WCO capacity building workshops in higher level research (for example, publishing PICARD conference papers via other channels), and (3), introducing useful research outcomes into future capacity building activities. The article also suggests how WCO regional structures can be more involved in the PICARD program and how such structures can play a unique role in promoting and transferring the key findings of high-quality research into practical outcomes.

## 1. Overview of the ROCB and RTCs in the A/P region

First of all, it is important to understand the origins and development of the WCO regional structures. It is well known that the WCO was established in 1952 in Brussels, Belgium as the only intergovernmental organisation specialising in customs matters. As of today, the WCO represents 183 customs administrations across the globe that collectively process approximately 98 per cent of world trade.<sup>1</sup> The WCO has devoted a lot of attention to improving the quality, relevance, and availability of its capacity building activities. A regional approach to performing effective and efficient capacity building activities, in close cooperation with regional members, is one of its priority initiatives to improve customs competences based on the needs of each region. The Asia/Pacific Regional Office for Capacity Building (known as the ROCB A/P) was officially launched on 28 September 2004 in the wake of the endorsement of the WCO Council Sessions in 2004.<sup>2</sup> The ROCB A/P was the first ROCB to be established and now other regions, namely the Americas/Caribbean (AMS), Europe (EUR), Middle East and North Africa (MENA), East and South Africa (ESA) and West and Central Africa (WCA), all have their own ROCB.

Like the ROCB, Regional Training Centres (RTC) constitute one of the key components of the regional approach. Forming virtually independent and autonomous entities, the regions are best placed to identify and respond to their members' training needs. This type of training, which is broader in scope than that offered to individual countries, makes it possible to pool and optimise resources within a single region. Such centres offer a number of advantages: they enable customs officials from neighbouring countries

to forge links with one another and they facilitate the follow-up of WCO programs in a region. To date, 29 RTCs have been established globally, with seven in the A/P region (in China, Fiji, Hong Kong China, India, Japan, Korea and Malaysia).<sup>3</sup>

What is the relationship between the ROCB and RTCs? The prime responsibility for the development and delivery of training lies with the RTCs. The ROCB, however, does play an important role, to (i) coordinate the activities of the Training Centres in the region, (ii) encourage the RTCs to develop specialist training products, for example, management training, business skills, enforcement and compliance, (iii) identify training needs at a strategic level and (iv) evaluate the impact of training at a strategic level.<sup>4</sup> Moreover, there is a formal annual communication mechanism, called the A/P RTC Heads Meeting, co-organised by the ROCB A/P and the RTCs, to discuss the most important issues of the year. For instance, this year, 2020, the 18th Meeting of Heads of the WCO A/P RTCs will focus on training methodologies under COVID-19. Note that this paper does not cover the role and purpose of the Regional Intelligence Liaison Offices (RILO) and Regional Dog Training Centres (RDTC), which are usually considered to be operational areas of the WCO.

## 2. The link between regional capacity building activities and the PICARD program

The WCO and its Regional Structures jointly organise many regional, sub-regional and national workshops covering different, sometimes controversial, topics, such as e-commerce, environmental protection and new technologies, to meet the needs of the 33 customs member administrations in the A/P region. A review of previous WCO PICARD conferences reveals that the most important topics discussed in the PICARD conferences are also addressed by the WCO workshops. The difference is that the conference is more focused on academic or theoretical aspects of the topics, while the workshops are more focused on practical ones. Hence, there are topics in common between the PICARD program and regional capacity building activities.

As the regional capacity building hub, the ROCB A/P actively attends and participates in WCO PICARD conferences. For example, Dr Tong Hua, the representative of the ROCB A/P, was invited by the WCO Research Unit to the 12th PICARD Conference held in Hammamet, Tunisia, on 26–28 September 2017. He was one of the speakers in a roundtable discussion session, ‘Partnership between Academia and Customs’. Dr Tong presented ‘Partnership between Academia and Customs: Practices in AP Region’. He introduced ROCB A/P’s main function, as well as selected cases from China Customs and Hong Kong Customs, to highlight the progress in research of the Customs National E-Learning Platforms in the A/P Region. He shared China, Japan and Korea Customs’ best practices in their capacity building activities, which were jointly designed and organised between academics and Customs.<sup>5</sup> Some RTCs in the A/P region also participate frequently in the PICARD conferences, a good example being the RTC-China, Shanghai Customs College, which has a unique dual function as both a university and training institute, and has contributed many high-quality papers to previous PICARD conferences.

ROCB A/P does not only participate in the PICARD conferences. In 2009 it established a think-tank to publish a good practices report, mainly to publicise the lessons learned, and recommendations from previous WCO workshops, and in 2016, it launched a new research initiative. In the course of the 14th Meeting of Heads of the WCO A/P RTCs held in November 2016 in Hong Kong, China, the delegates had an opportunity to visit the RTC Hong Kong, and observed a vivid demonstration of their E-Learning system, which provided the delegates with invaluable food-for-thought for their in-depth discussion on the ROCB A/P’s think-tank function. Accordingly, the delegates tasked the ROCB A/P to conduct a study on the impact and good practices of the development and use of E-Learning training modules for customs professionals. The ROCB A/P was inspired by the lively discussion, and published a research paper on this study.<sup>6</sup>



### 3. Recommendations and the way forward

#### 3.1 ROCB and RTCs can play a more important role in utilising their think-tank function

It is considered that the ROCB A/P should closely cooperate with the WCO Secretariat's research unit to:

- conduct joint research
- act as the regional information collection platform by submitting regional best practices
- co-host regional research conferences when funded by donors, following the same model as used by the WCO ESA ROCB regional research conference.

It should also encourage more RTCs to invest resources into research to become centres of excellence. Some RTCs already have a very solid foundation and tradition in research. As mentioned earlier, RTC-China, Shanghai Customs College, is a university that offers master's and bachelor's degrees. They have a rich resource of faculty members and students, which lends itself to more, high-quality research projects. Another example is the RTC Korea Customs Border Control Training Institute (CBCTI). This institute has created positions for professors who undertake research in order to develop training subjects, and who also design the textbooks used for training.

#### 3.2 Use the outcomes of the WCO capacity building workshops as the basis for higher level research

Currently, there are ROCB Annual Reports, Customs Good Practice Reports, ROCB E-Newsletters (Special Essays from the members) and internal mission reports prepared by the ROCB A/P. These cover all types of successful capacity building activities and best practices from members and provide a database of highly valuable capacity building resources. In the future, the ROCB A/P should capitalise on those articles and recommend selected high-quality research reports for presentation in the PICARD conference on behalf of the A/P region research series.

Another possible research approach is the WCO-ROCB-RTC cooperation model. In 2016, the ROCB A/P proposed a new initiative, the compilation of a research/study paper on the regional workshops hosted by the respective RTCs. There are four expected benefits from such an initiative:

- the further promotion of WCO tools and instruments
- better recognition of the current situation in the A/P region
- more strategic capacity building (CB) activities for members in the A/P region
- more practical networks among members in the A/P region, WCO, RTCs and ROCB.

In order to maximise the benefits of the 'WCO A/P Regional Workshop on HS 2017 Implementation', held from 18–22 April 2016 at the RTC Japan, the ROCB A/P together with the RTC Japan compiled an Asia/Pacific Regional Study Paper on preparation for HS 2017. This paper included technical advice from the WCO Secretariat with reference to the workshop materials and replies from the participants to a questionnaire distributed prior to the Regional Workshop. Such a successful cooperation model, integrating the capacity building workshop outcomes with research initiatives, would have a positive impact in delivering more strategic and practical capacity building activities for those member administrations in need of support.

### 3.3 Implement the key findings of high-quality research through future regional capacity building activities

Through the PICARD conference, participants can learn from different stakeholders' (academia, private sector, and other border agencies) perspectives, which may broaden their understanding of customs topics when discussed from a global perspective. As mentioned previously, most of the topics covered at these conferences have also been discussed among member administrations through workshops. Thus, the PICARD conference is an excellent opportunity to hear the latest information on these topics from different angles, viewpoints, and groups. To improve the assessment of members' needs, it would be useful if the ROCB A/P proposed to the WCO Secretariat to include them in the workshops' corporate plans. In this case, the ROCB A/P should actively participate in PICARD conferences to maintain the currency of their knowledge of emerging issues.

In this way, the ROCB can play a unique bridging role in introducing and promoting the most relevant research outcomes of PICARD conferences to regional members. This role would also further enhance customs competences via the organisation of regional capacity building activities, and by sharing the highlights of conference outcomes. In addition, key research findings, such as those relating to data analytics, cross-border e-commerce models and new technologies applied to customs, could be used as the basis for future regional capacity building workshops.

#### Notes

- 1 Discover the WCO, the WCO official website [www.wcoomd.org/en/about-us/what-is-the-wco/discover-the-wco.aspx](http://www.wcoomd.org/en/about-us/what-is-the-wco/discover-the-wco.aspx)
- 2 History of ROCB A/P [rocb-ap.org/service/44/](http://rocb-ap.org/service/44/)
- 3 Regional Training Centres [www.wcoomd.org/en/about-us/wco-regional-bodies/regional\\_training\\_centres.aspx](http://www.wcoomd.org/en/about-us/wco-regional-bodies/regional_training_centres.aspx)
- 4 ROCB and RTC Guidelines [www.wcoomd.org/-/media/wco/public/global/pdf/topics/capacity-building/overview/guidelines\\_rocb\\_rtc\\_en.pdf?db=web](http://www.wcoomd.org/-/media/wco/public/global/pdf/topics/capacity-building/overview/guidelines_rocb_rtc_en.pdf?db=web)
- 5 ROCB A/P speaks at the 12th WCO Annual PICARD Conference. 28 September 2017 [www.rocb-ap.org/article-detail/368/](http://www.rocb-ap.org/article-detail/368/)
- 6 Please refer to Dr. Tong Hua's article, *Key Findings of the ROCB A/P Study on the Impact and Good practices of the development and the Use of E-Learning Training Modules for the Customs Professionalism and human resource development. 2017.* [www.rocb-ap.org/file\\_media/file\\_document/upload/ENL59.pdf](http://www.rocb-ap.org/file_media/file_document/upload/ENL59.pdf)

#### Dr Tong Hua



Dr Tong Hua is an assistant researcher at Shanghai Customs College, a member of the Research Association of China Customs, a former acting director of the Research Centre of China Customs, and since November 2016, a secondment official from China Customs to the WCO Regional Office for Capacity Building of Asia Pacific, Bangkok, Thailand. He is also a WCO-accredited Customs Modernization Advisor (Human Resource Management and Development, HRM & HRD).

# Customs capacity building through Partnership in Customs Academic Research and Development (PICARD): achievements and future directions.

*Mikhail Kashubsky and Juha Hintsa*

## Abstract

---

This paper discusses how the World Customs Organization (WCO) has been cooperating with the academic community in the context of the WCO Partnership in Customs Academic Research and Development (PICARD) program, in order to enhance the capabilities and professionalism of customs administrations and customs experts through higher education and to better inform strategic customs decision-making through applied academic research. It discusses key PICARD initiatives and achievements and seeks to determine whether the PICARD program has met its objectives and fulfilled stakeholders' expectations. It also addresses the program's future directions and considers how it can continue to keep pace with the rapid changes affecting Customs, and how it can be further developed and enhanced for the benefit of all stakeholders.

---

## 1. Introduction

At the turn of the 21st century, capacity building became a matter of high priority on the World Customs Organization (WCO) agenda. According to the WCO, the challenges and demands of the 21st century posed by factors such as globalisation, rapid technological developments, global security concerns and the dynamic nature of international trade, necessitate a professional approach to the management and operations of customs administrations (WCO, 2008b). The role of a modern customs manager demands an understanding of complex issues and the ability to transform knowledge into practical applications and operational policies using latest techniques, best practices and new technology, which requires a much higher level of knowledge and broader set of skills and behavioural attributes than has been traditionally required (Mikuriya, 2007; Danet, 2007).

Recognising that the increasing complexity of customs work requires a more rigorous approach to customs education and training and that it can benefit from more academic research, the WCO decided to develop a cooperative partnership with the academic world. This led to the introduction of the WCO Partnership in Customs Academic Research and Development (PICARD) program in 2006, effectively providing a framework for the cooperation between Customs and academia. Since then, a number of important initiatives have been introduced and jointly progressed.

As the PICARD program is approaching its 15th anniversary, it is timely to reflect on what has been done and achieved to date, as well as on what remains to be done. This paper provides an overview of the PICARD program, its key initiatives (or rather instruments) and their objectives, and discusses PICARD's outcomes and achievements, in order to determine whether the PICARD program and related

PICARD instruments have met their objectives and fulfilled stakeholders' expectations. It also considers how PICARD can continue to keep pace with the rapid changes affecting the world of Customs and how it can be further developed and enhanced for the benefit of all stakeholders.

## 2. PICARD program overview

The WCO PICARD program was introduced in January 2006 and officially launched at the 1st PICARD conference in March 2006. At that time, there were no established standards for the customs profession, no recognition of Customs as an area of legitimate academic pursuit, no internationally recognised academic programs in Customs, no academic journals dedicated specifically to customs matters, and no international conferences at which the customs and academic communities could exchange ideas and report research results (Widdowson, 2015b).

Recognising that research and professionalism are necessary tools of many governments around the world; the aim was to advance customs professionalism and to advance customs-related research (WCO, 2007). According to Widdowson (2015b), since the PICARD program's introduction, the collective aim has been to raise the academic standing of the customs profession, but it was not always clear how this would be achieved. However, *research* and *professionalism* have been the two pillars of the PICARD program since the beginning, and the program's objectives have been:

- to raise the academic profile of the customs profession
- to raise the professional knowledge and standing of customs practitioners
- to provide a cooperative framework for cooperation between Customs and academia
- to encourage more academic research in the customs field
- to encourage national adoption of integrated education, training and development schemes by education authorities
- to initiate new approaches to whole-of-career development strategies
- to encourage academic institutions and customs administrations to increase their cooperation in the field of customs education and research
- to promote the development of educational products and services and explore potential resources for funding
- to support the future activities related to this collaboration (WCO, 2008c).

In PICARD's early days, senior officials of the WCO expressed their hopes that this partnership would attract many participants and would also encourage multilateral cooperation (WCO, 2005b). In the intervening 15 years, the WCO in partnership with academia and other stakeholders have progressed several important initiatives under the PICARD program and several milestones have been reached. Table 1 provides a snapshot of the PICARD timeline, its key initiatives, and milestones.

Table 1: PICARD timeline and milestones

<b>Feb 2005</b>	International Network of Customs Universities (INCU) established
<b>Jan 2006</b>	PICARD program introduced
<b>Mar 2006</b>	First PICARD conference held (Brussels, Belgium) and PICARD program launched
<b>Mar 2007</b>	2nd PICARD conference held (Brussels, Belgium) and World Customs Journal (WCJ) launched
<b>Mar 2008</b>	PICARD Advisory Group formed
<b>May 2008</b>	3rd PICARD conference held (Shanghai, China) and WCO Professional Standards published
<b>Jun 2009</b>	WCO adopts Professional Standards and Curricula Recognition Guidelines
<b>Sep 2009</b>	4th PICARD conference held (San Jose, Costa Rica) and WCO and INCU signed a Memorandum of Understanding (MOU)
<b>Jan 2010</b>	WCO accredits first academic programs under Professional Standards
<b>Nov 2010</b>	5th PICARD conference held (Abu Dhabi, United Arab Emirates) and WCO announces 'knowledge' as its theme for 2011
<b>Sep 2011</b>	6th PICARD conference held (Geneva, Switzerland) and it was agreed to develop PICARD Strategy 2020
<b>Sep 2012</b>	7th PICARD conference held (Marrakech, Morocco) and WCO and INCU re-signed the MOU
<b>Feb 2013</b>	WCO adopts the PICARD 2020 Strategic Document
<b>Sep 2013</b>	8th PICARD conference held (Saint Petersburg, Russia) and PICARD Youth Forum launched
<b>May 2014</b>	Inaugural INCU Global Conference held and INCU Baku Resolution adopted
<b>Sep 2014</b>	9th PICARD conference held (Puebla, Mexico)
<b>Feb 2015</b>	INCU celebrates 10th anniversary
<b>May 2015</b>	WCO establishes the PICARD Scientific Board
<b>Sep 2015</b>	10th PICARD conference held (Baku, Azerbaijan) and INCU Baku Regional Office opened
<b>Mar 2016</b>	PICARD program's 10th anniversary
<b>Sep 2016</b>	11th PICARD conference held (Manila, the Philippines) and 10 years of WCJ was acknowledged
<b>Sep 2017</b>	12th PICARD conference held (Hammamet, Tunisia)
<b>Oct 2018</b>	13th PICARD conference held (Malatya, Turkey)
<b>Apr 2019</b>	WCO adopts revised Professional Standards and revised Curricula Recognition Guidelines

<b>Oct 2019</b>	14th PICARD conference held (Skopje, North Macedonia)
<b>Feb 2020</b>	INCU celebrates 15th anniversary
<b>Mar 2020</b>	WCO unveils the PICARD 2030 Strategic Document
<b>Nov 2020</b>	15th PICARD conference (upcoming, web-conference)
<b>Jan 2021</b>	PICARD program's 15th anniversary

Source: authors.

Initially, it was agreed that the WCO in partnership with the International Network of Customs Universities (INCU) would work together to organise a conference specifically dedicated to cooperation between Customs and academia; develop an academic journal to publish research on customs-related topics; and investigate the possibility of developing international professional standards for the customs profession and setting up the process of WCO recognition of academic customs programs (WCO, 2005a; WCO, 2005b). Looking at how PICARD has developed over time, it can be noted that cooperation between the WCO and academic institutions has led to the introduction of several key initiatives including the establishment of the INCU, the creation of the *World Customs Journal (WCJ)*, organisation of annual PICARD conferences, the development of the WCO Professional Standards for operational and strategic customs managers and the associated process of recognition of university customs curricula.

The successful introduction of these initiatives into the PICARD program can be considered an achievement in itself, considering that the development of these initiatives required an investment of a considerable amount of time and other resources, as well as a collaborative approach and active engagement of all who were involved in the development of PICARD. In that regard, it can be argued that at least some of the objectives of the PICARD cooperation had already been achieved more than 10 years ago, in the earlier stages of the program's development.

However, each of these initiatives was developed for a particular purpose and with a specific set of objectives, aiming to achieve certain outcomes. In effect, these initiatives are the tools or '*PICARD instruments*' that have been created for use by stakeholders, to help them achieve their desired outcomes, so the introduction of these instruments was just an intermediate step, only a means to an end, and not the final output. Therefore, it is first important to review the purpose and objectives of each of these instruments in order to determine whether those objectives have been achieved and whether the expectations of all stakeholders have been met.

### 3. Overview of PICARD instruments and their objectives

Specifically, the following have been identified as PICARD instruments on which the subsequent discussion will focus: 1) the network of academic institutions, 2) the academic conference, 3) the academic research journal, 4) the advisory group, 5) the professional standards, 6) recognition of university programs, 7) Memorandum of Understanding, 8) the strategic document and 9) the scientific board. These PICARD instruments and their specific aims and objectives are outlined below, while the resulting outcomes that ensued from these instruments are discussed in section 4.

### 3.1 The INCU network

Recognising the need for a mechanism that would facilitate better networking and coordination among universities with an interest in customs research and education and the need for a single body to represent the common interests of academia, in February 2005 academic institutions established the INCU. The INCU is an international not-for-profit organisation established with the main aim *to promote the academic standing of the customs profession*. At the time of its establishment, the objectives of the INCU were to:

- promote academic excellence in customs law and administration
- generate greater public awareness of customs matters
- provide the WCO and other organisations with a single point of contact with universities and research institutes that are active in the field of customs research, education and training
- develop an international customs academic journal
- provide a global resource for governments and the private sector, and an educational source for students wishing to further their knowledge in the field of customs, international trade, and logistics (INCU, 2007).

Subsequently, the INCU objectives were amended (see INCU, 2020e) to:

- promote the academic standing of the customs profession
- promote academic excellence in customs matters
- support research in customs matters
- generate greater public awareness of the customs profession
- promote the collective interests of its members
- provide the WCO and other organisations with a single point of contact with universities and research institutes that are active in the field of customs research, education and training; organise academic conferences
- provide a global resource for governments and the private sector, and an educational source for students wishing to further their knowledge in the field of customs, international trade, and logistics (INCU, 2014).

It was intended that, among other things, the INCU would serve as a mechanism for academic institutions and individuals to contribute to the customs knowledge base ‘and to exchange ideas and best practice that not only helps organisations and individuals to build capacity but also serves to build closer links between government, academia and the private sector’ (Widdowson, 2015b, p. 216). The INCU website was intended to provide a platform for developing a comprehensive database of universities and other academic institutions involved in customs research, education, training, development, and capacity building activities, and a means for disseminating information about the PICARD program, its activities and developments as well as other items of interest to the academic community (INCU, 2007).

### 3.2 PICARD conference

The PICARD conference is another important early initiative and instrument of PICARD. The inaugural PICARD conference was held in March 2006 at the WCO headquarters in Brussels and was designed to:

- provide a forum for constructive ideas for the advancement of academic research and professionalism in the customs domain
- bring together and emphasise the link between Customs and academic institutions
- guide the future policy of the WCO on its engagement in the field of academic research and customs professionalisation
- further formalise the relationship between the WCO and academic institutions
- facilitate the development of a global network of academic institutions (WCO, 2006; WCO, 2007).

One specific objective during the 1st PICARD conference was to identify and discuss research areas and topics relevant to the global customs community. Following a literature review and a survey with a broad community of customs experts, academic community, and supply chain professionals, Hintsa (2006) suggested multiple topics in need for future research, including (i) finding the right balance between security and facilitation; (ii) identifying benefits of security measures; (iii) developing business–customs relationships; and, (iv) risk reduction/prevention.<sup>1</sup> It is worthwhile to note that a number of research papers and panel sessions have focused on these topics since then, throughout the 14 PICARD conferences held to date, but conference papers and presentations also covered many other topics of interest to the customs community.

### 3.3 World Customs Journal

Responding to the identified need to improve the quality of information available to customs managers on the basis of which important strategic and operational decisions could be made, the *WCJ*, initiated by academic institutions through the INCU, was officially launched at the second PICARD conference in March 2007. This marked another important milestone in the development of the PICARD program. To ensure academic rigour and quality of the publication, the *WCJ* was set up as a peer-reviewed academic journal and has become the INCU's flagship publication.

The *WCJ* was primarily created to provide a forum for customs professionals, academics, industry researchers, and research students to contribute items of interest and share research and experiences to enhance its readers' understanding of all aspects of the roles and responsibilities of Customs (INCU, 2020f). At the time of its launch, the WCO leaders expressed their hopes that the journal 'will grow as a valuable reference source for the customs community to meet the requirements of the new strategic environment and for the wider international community to deepen their understanding of the customs world' (Mikuriya, 2007, p. v; Danet, 2007, p. v).

### 3.4 PICARD Advisory Group

The next instrument introduced under the PICARD program was the creation of the PICARD Advisory Group (PAG) in March 2008, comprising of WCO officials and representatives of academic institutions selected on the basis of their active participation and contribution to the development of the PICARD program. The purpose of the PAG was to assist the WCO with the delivery and management of the program and to promote cooperation and open dialogue. Initially, the role of the PAG included:

- providing advice on WCO Professional Standards, including advice concerning their ongoing validity



and recommendations for change, as required

- preparation and planning of the annual PICARD conferences
- following on and resolving issues arising at the PICARD conferences (and elsewhere) of relevance to the PICARD program (Karlsson, 2008; Widdowson, 2008c).

The original members of PAG were: Michael Wolfgang, University of Muenster, Germany; Aivars Krastins, Riga Technical University, Latvia; Jan Janson, Riga Technical University, Latvia; Juha Hintsa, Cross-border Research Association, Switzerland; Stephane Lauwick, University of Le Havre, France; Claire Morris, Leeds Metropolitan University, United Kingdom; and David Widdowson, Centre for Customs and Excise Studies, Australia (Karlsson, 2008).

### **3.5 Professional Standards**

In parallel, working in cooperation, the INCU and WCO developed a set of common international standards for strategic and operational customs managers, which were published and discussed at the 3rd PICARD conference in May 2008 (WCO, 2008b), and were endorsed by the WCO Council in June 2009. The publication of the WCO Professional Standards marked another major achievement of the PICARD program. As argued by Fonseca (2008, p. 12), collaboration under the framework of PICARD ‘is firmly based on international standards and aims to reflect the requirements of contemporary society’.

Subsequently, the Professional Standards were revised, and a new version was adopted by the WCO in 2019. The key updates, which, according to the WCO (2020c, p. 21), ‘reflect new challenges stemming from changes in the customs operational environment’, include a general simplification and reorganisation of the standards, and a stronger emphasis on emerging technologies, risk management, security and facilitation, coordinated border management, and international supply chains (WCO, 2019a, p. 9). According to the WCO (2008b, p. 10; 2019a, p. 10), the Professional Standards provide for:

1. the establishment of benchmarks which can be developed into job profiles for customs recruitment
2. the development of benchmarks against which the member’s current in-house training can be measured
3. the development of standards against which academic development can be designed or procured
4. benchmarks against which the private sector can design standards for customs professionals.

### **3.6 Recognition of university curricula**

At the same time, complementary to the Professional Standards, the WCO and INCU jointly developed guidelines that established a formal assessment and recognition process for university customs curricula at the bachelor and master’s levels. The aim was to enable educational programs that comply with the Professional Standards to be formally recognised by the WCO and bear the WCO label certifying that the program meets the international standards for the customs profession (WCO, 2019a). The WCO recognition guidelines (WCO, 2009) were endorsed by the WCO Council in June 2009 and were subsequently amended in 2013 and 2019 (see WCO, 2019b).

### **3.7 WCO-INCU Memorandum of Understanding**

The next significant milestone in the partnership between the INCU and the WCO was achieved in September 2009 with the signing of an MOU between the two organisations, at the 4th WCO PICARD conference that was held in San Jose, Costa Rica. The MOU, which formally recognised the INCU as the single point of contact between the WCO and those universities and research institutes that are active in the field of customs education and research, serves to formalise their joint efforts to promote the academic standing of the customs profession (Widdowson, 2009).

The MOU's objective is to 'promote co-operation in the development and provision of world-class customs training, education, capacity building and research', whereby the WCO and INCU agreed, among other things, to:

develop a long-term strategic alliance that will mutually benefit each other's aims and objectives; to permit reference to the professional association between the organisations to be made by either party in public documents; to recognise the status of the WCO and INCU as international representative bodies; to explore opportunities to cooperate in the areas of training, education, research, e-learning, capacity building and management development; to seek to optimise the level of synergies between the training and capacity building provided by the WCO and its members and the education and training programmes provided by the INCU members; to explore opportunities to jointly enhance Customs training, education, research and capacity building activities; and to facilitate cooperative arrangements including, but not limited to, providing each other with observer status at each other's annual meetings, as well as appropriate access to each other's websites (INCU & WCO, 2009; INCU & WCO, 2012).

Subsequently, the two organisations signed a replacement MOU at the PICARD conference in Morocco in 2012 to reflect a change in the legal name of the INCU to 'International Network of Customs Universities'.

### 3.8 PICARD Strategic Document

Recognising that the world economic context and the global environment in which customs administrations operate has changed significantly since the commencement of PICARD, and that the program needs a strategic direction in order to remain agile and responsive, the WCO in consultation with the INCU and other stakeholders, in late 2011, commenced preparation of the PICARD 2020 Strategic Document (WCO, 2013), which was adopted by the WCO in 2013. Subsequently, in late 2019, a revised version of the PICARD strategy was developed and the PICARD 2030 Strategic Document (WCO 2020a), was endorsed by the WCO Capacity Building Committee in March 2020 (WCO, 2020c).

According to the WCO (2013, p. 1), the aim of the original strategic document was to outline the vision, strategy and key elements to further enhance the PICARD program partnership between the WCO and partners from academia and the private sector related to effective tackling of key questions arising from past PICARD conferences and interactions as well as those raised by the WCO Capacity Building Committee. The PICARD 2020 Strategic Document goes on to list six initiatives (see WCO 2013, pp. 1–2), which can be summarised as follows:

- to promote integration of research outcomes and advice in customs modernisation efforts
- to make best use of and build on the Professional Standards developed within the PICARD program
- to further promote Customs as a knowledge-based profession
- to enhance regional representation and global coverage within the PICARD program
- to consolidate cooperation between academic institutions and regional and national customs training centres

- to secure, maintain and expand involvement of WCO member administrations, academia and the private sector in this program.

The PICARD 2020 Strategic Document also contains a Vision Statement announcing that the PICARD program ‘aims to be: indispensable to the professional development for all Customs practitioners, influential to Customs decision makers by [promoting] knowledge-based research, and successful by partnering with academia and other relevant stakeholders’ (WCO, 2013, p. 3). The new PICARD 2030 Strategic Document has the same aim as the PICARD 2020 Strategic Document, which is ‘to outline the vision, strategy and key elements to further enhance the PICARD Programme partnership between the WCO and partners from academia and the private sector’ (WCO, 2020a, p. 2). The Vision Statement in the PICARD 2030 Strategic Document had been slightly amended stating that ‘the PICARD Programme aims to be: responsive in shaping the future of Customs, indispensable to the professional development of all Customs practitioners, influential to Customs decision makers by providing academic and applied research, and successful by partnering with academia and other relevant stakeholders’ (WCO, 2020a, p. 3). The PICARD 2030 Strategic Document has yet to be formally adopted by the WCO Council.

### **3.9 PICARD Scientific Board**

In 2015, WCO decided to establish another advisory team, the PICARD Scientific Board (PSB), with a specific purpose of reviewing and selecting papers and presentations for the PICARD conferences. Unlike the PAG with a long-term composition, the PSB is appointed by the WCO on an annual basis and is typically comprised of academic and customs experts, representatives of the conference host organisations, as well as WCO Secretariat officials directly responsible for organising the conference. The PSB and its related procedures and activities are coordinated by the WCO Research Unit which has had the responsibility for organising PICARD conferences since 2014. Typically, the WCO Research Unit sends each PSB member a set of submitted documents such as research papers, presentations and panel proposals. PSB members then undertake a peer review and provide their decisions to the WCO Research Unit. The WCO then takes the advice of PSB members into consideration and makes the final decision on paper and presentation selections. The first PSB was formed in May 2015 for the 10th PICARD conference held in Baku, Azerbaijan,<sup>2</sup> and since then has been a regular feature in the organisational and planning stages of the PICARD conferences.

## **4. Achievements and outcomes of PICARD instruments**

Having briefly discussed the key PICARD instruments and their objectives, it is appropriate to consider the results and outcomes generated through or by these PICARD instruments. This section of the paper provides a summary of outcomes and achievements of each of the instruments. The extent to which these instruments, and the PICARD program as a whole, have achieved their intended objectives, is addressed in section 5.

### **4.1 The INCU network**

Initially, the INCU was established as a non-incorporated association, not a legal entity. As the INCU and the PICARD program continued to evolve, it has become necessary to formalise its governance arrangements to continue to fulfil its objectives and, in 2008, the INCU became a legal entity registered as an incorporated association. This meant that the INCU could now engage in contractual arrangements with other organisations and stakeholders in order to remain a key player in developing the PICARD program and continue to drive the PICARD agenda, as well as to continue to provide useful services to its members.

Established in 2005, the INCU has grown into a dynamic non-governmental international organisation representing the collective interests of institutions and individuals who are active in the field of customs

research and education, and this year the INCU celebrates its 15th anniversary. In its 15 years of existence, the INCU has built its reputation and achieved international recognition as an organisation that can provide valuable academic input in the areas of Customs, border management and international trade. The efforts of the INCU have been recognised not only by the WCO, but also by other prominent international organisations such as the World Trade Organization (WTO). For example, the Director-General of the WTO publicly commended INCU for its role in promoting the trade facilitation agenda (see Azevêdo, 2015).

Having firmly established itself as a reputable international organisation, the INCU took steps to further develop its organisational arrangements. In response to a growing demand from the academic and customs community, in 2012, the INCU underwent an organisational and membership restructure and expanded its membership rules to allow not only institutions, but also individuals to become members in order to facilitate an expanded policy, and management input from across the INCU membership that will provide an opportunity for all members to participate in its management and decision-making processes (INCU, 2020e; Widdowson, 2011b).

While at the time of its establishment, the INCU membership base comprised of only four institutions,<sup>3</sup> the membership has been steadily growing and today the INCU represents some 340 members from more than 80 countries, which include academic institutions, customs administrations, private sector companies and individuals (INCU, 2020d). Over the years, the INCU has progressed and implemented a number of its own initiatives such as providing advice and assistance to members with respect to the WCO Professional Standards and recognition process, supporting academic journals, running student internship programs and organising academic conferences (the inaugural INCU global conference took place in May 2014 in Baku, Azerbaijan). In September 2015, the INCU established its first regional office in Baku, which marked another milestone in its development (INCU, 2020b). The INCU website, which was intended to be a mechanism for coordination among academic institutions and a global resource for those interested in customs affairs, customs education and research, has been upgraded several times since its launch and now has a members-only library of PICARD-related materials as well as other resources and publications.

### 4.2 PICARD conference

The PICARD conferences have proved to be an excellent avenue to guide the future policy of the WCO on its engagement in the field of education and academic research and to pave the way for future directions for the PICARD program. The main achievement of the first PICARD conference was the decision to formalise cooperation between the WCO and academia by way of the PICARD initiative, more specifically, to establish an academic journal dedicated to customs matters and to pursue the development of professional standards and associated procedures for formally recognising university customs curricula.

The PICARD conference has become one of the major annual WCO conferences that serves as a regular exchange, discussion and networking platform for researchers, educators and practitioners in the customs context (WCO, 2020a), and it provides a great opportunity for all PICARD stakeholders to get together, to share experiences and debate ideas, and to identify how this unique customs-academia partnership can be better utilised for the benefit of all stakeholders (Widdowson, 2011a). To date, 14 PICARD conferences have been held (see Table 1), each conference building on the success of the previous ones. The annual PICARD conference provides a forum for academics and practitioners to debate ideas and share research findings and has ‘served to highlight the synergies of the WCO and INCU and to identify areas in which collaboration is not only possible but highly desirable’ (Widdowson, 2015a, p. v). Priority research themes and related topics of the PICARD conferences over the 15 years, as announced in Calls

for Papers, are presented in Table 2.

*Table 2: PICARD Call for Papers 2006–2020*

<b>Conference</b>	<b>Conference themes and topics highlighted during 2006–2020</b>
15th PICARD (Nov 2020)	Lessons learned regarding Customs' response and role in supply chain continuity during the COVID19 pandemic; Customs fostering Sustainability for People, Prosperity and the Planet; and Organizational Performance Measurement.
14th PICARD (Oct 2019)	Big Data Analytics, Coordination and Cooperation at Borders, Cross-border E-commerce, Special Economic Zones, Technology at the Border, Predominance of Protectionism.
13th PICARD (Oct 2018)	Securing the Business Environment; Data Analysis; Trade Facilitation; Cross-border e-Commerce; Connectivity in Customs; and Customs and the Fourth Industrial Revolution.
12th PICARD (Sep 2017)	Data Analysis; Trade Facilitation; Security; and Customs-Tax Cooperation.
11th PICARD (Sep 2016)	Digital Customs; Security; Taxation and other revenue matters; and Illicit trade.
10th PICARD (Sep 2015)	Connection between global value chains (GVC) and Customs procedures, Taxation and other revenue matters, and Smuggling.
9th PICARD (Sep 2014)	WTO Agreement on Trade Facilitation: Implications for Customs; Digital Dilemma in Customs; and Customs Role in Securing Supply Chains and Preventing Illegal Trades.
8th PICARD (Sep 2013)	The impact on Customs of the development, implementation, and administration of regional integration initiatives; The WCO Economic Competitiveness Package (ECP); and Enhancing Professionalism in Customs: how to operationalise the PICARD 2020 Strategic Document.
7th PICARD (Sep 2012)	Emerging and evolving risks on Customs administration; The Impact of Regional Economic Integration and Preferential Trade Arrangements on Customs Services; and Customs Strategic Human Resource Management.
6th PICARD (Sep 2011)	Coordinated border management, Performance measurement of Customs, Economic security and poverty reduction, Integrity.
5th PICARD (Nov 2010)	Customs-Business partnerships; Performance measurement; Customs and revenue collection; and the Impact of climate change on international trade and customs management in the post-Copenhagen era.

4th PICARD (Sep 2009)	The impact of the economic crisis on Customs and international trade; the impact of Regional Trade Agreements on Customs and trade; the impact of climate change and environmental protection on Customs and trade.
3rd PICARD (May 2008)	The pilot projects based on the PICARD professional standards developed by the WCO together with the INCU; recent academic research and existing educational programs and future research capabilities related to Customs; research needs and areas identified by the customs administrations to assist them to achieve their strategic objectives; increasing the knowledge and interest of the donor organisations about the academic research projects related to Customs.
2nd PICARD (Mar 2007)	To develop a set of professional standards for strategic managers; to launch the first edition of the WCJ with the theme ‘Customs in the 21st Century’ and discuss the content of the second edition; to review and discuss recent innovative research material on supply chain security as a prelude to its inclusion in the second edition of the Journal; to provide an opportunity for institutions to join the INCU.
1st PICARD (Mar 2006)	To examine existing and current research in the field of Customs; to explore how the institutions and the WCO could play a role in further development; to examine the need for professionalism in Customs; to examine how the field of Customs could be developed as a specialised area of study; to determine how academic programs recognition could be standardised and accepted internationally.

*Source:* authors based on WCO (2020b) and INCU (2020c). Note: the right column in Table 2 presents a non-exhaustive list on themes and topics, meaning that submissions on other topics have also been accepted.

Despite the seemingly broad variation in the research themes across the conferences, a few topics appear to be repeated occasionally, including data analytics, digital customs, security, climate change impact, customs performance management, illicit trade, e-commerce and taxation matters. One item to consider is whether a more proactive, multi-year research theme planning, would make sense in the future. One could opt for example to repeat in every second conference certain research themes and topics of fundamental customs importance. These could include rapidly evolving themes such as e-commerce and extraordinarily complex themes such as data analytics.

Next, achieving practical relevance is a common challenge in academic research, including those presented and discussed in PICARD conferences. Table 3 illustrates the theme of producing explicit ties between academic research generated through PICARD and the real customs world. The examples consist of Cross-border Research Association (CBRA) and the Centre for Customs and Excise Studies (CCES) research projects that address customs research topics of importance identified through PICARD and that have been presented and discussed at past PICARD and INCU conferences during 2014–2019.

*Table 3: Examples of PICARD research links with the ‘real customs world’*

<b>Research area/topic</b>	<b>Research publication (and conference where it was presented)</b>	<b>Links with the ‘real customs world’</b>
----------------------------	---	--

Enhancing Customs Risk Management with Big Data and Data Analytics	Männistö T., Hintsa J., Migeotte J., Molenhuis M., Alpstedt A., Wong Chan S., & Hameri A-P. (2019). (Presented at the 14th PICARD conference)	Five WCO member administrations are active partners in 3-year H2020 PROFILE project, <sup>4</sup> exploring, e.g. usage of external data sources in customs risk assessment.
Review of Australia's Progress Towards Implementation of the Single Window	Widdowson, D., Blegen, B., Short, G., Lewis, G., Garcia-Godos, E., Kashubsky, M., Baker, H., & Juratowitch, B. (2018). (Presented at the 2nd INCU International Student conference 2017).	Research provided advice to the Australian Border Force and the Australian industry on the latest international trends on establishing Single Window and How to Take It Forward in Australia.
Customs-Academia Collaborative Research-Development-Innovation Projects	Hintsa, J., Wong Chan, S., Grainger, A., & Czyżowicz, W. (2018). (Presented at the 13th PICARD conference).	Thirteen WCO member administrations are active partners in 5-year H2020 PEN-CP project, <sup>5</sup> trialling a variety of Open Innovation instruments.
Trade Facilitation and Border Management Performance Measurement	Hintsa, J., & Männistö, T. (2017). (Presented at the 12th PICARD conference).	Research materials exploited, e.g. in a Global Alliance for Trade Facilitation (GATF) capacity building project.
Review of Australia's National Committee on Trade Facilitation	Widdowson, D., Blegen, B., Short, G., & Kashubsky, M. (2017). (Presented at 2nd INCU International Student conference 2017).	Research project, commissioned by the Australian international trading industry, provided advice to the Australian Government and industry on latest international trends in establishing National Committees on Trade Facilitation.
Authorised Economic Operator Program Benefits	Hintsa, J., Urciuoli L., & Tan, Y. (2016). (Presented at the 11th PICARD conference). <sup>6</sup>	Research data on Authorised Economic Operator (AEO) programs and associated benefits was collected during WCO Global AEO conferences (2014 and 2016; plus final follow-up in 2018).
Global Customs Revenue Benchmarking Database	Hintsa, J., Wong, S., Rudzitis, N., Phan, H., Mommen, B., Hameri, AP., Heijmann, F., & Männistö, T. (2015). (Presented at the 10th PICARD conference).	Research triggered a follow-up process in WCO to explore in detail features and benefits of revenue benchmarking databases.
Review of Accredited Operator Schemes: Enhancing the Competitiveness of Australia's International Traders	Widdowson, D., Blegen, B., Kashubsky, M., & Grainger, A. (2014). (Presented at the Inaugural INCU Global conference and 10th PICARD conference).	This research project was a major catalyst in the introduction of the Australian Trusted Trader program by the Australian Government in 2015.

<p>Customs Role in Minimising Negative Socioeconomic Impacts of Trafficking</p>	<p>Hints, J., Mohanty, S., Rudzitis, N., Fossen, C., &amp; Heijmann, F. (2014). (Presented at the 9th PICARD conference).</p>	<p>Research helped multiple WCO members to better understand and articulate the value of customs to society.</p>
---	---	--

Source: authors. See also Hints (2014).

While the majority of papers and presentations in future PICARD conferences may remain of an independent academic research nature, and stand alone to an extent, it would be a good idea to encourage showcasing research projects and activities with a reasonable degree of practical relevance to the customs community.

As the last observation on PICARD conferences, the 8th conference held in Saint Petersburg, Russia in September 2013 for the first time included in its program a Youth Forum, which has now become a regular part of the conferences. The PICARD Youth Forum brings together customs students from various academic institutions and provides a great opportunity for them to participate in PICARD conferences, and to network and discuss their ideas and research on topics related to the conference with more experienced customs professionals and academics from around the world. As noted by the PAG, the Youth Forum complements the PICARD conference and strengthens the PICARD initiative as a whole, and provides an effective student-expert exchange platform (WCO, 2014).

### 4.3 World Customs Journal

The *WCJ* has remained the INCU’s flagship publication and is recognised as the leading international academic journal on customs matters. The journal continues to be published twice a year and 27 editions of the *WCJ* have been published to date (INCU, 2020f). The *WCJ* contributors represent a broad range of professionals including academics, students, researchers, and officials from customs administrations, the WCO, other government agencies, as well as practitioners from the private sector. The practitioner contributions that are published in the *WCJ* usually provide some excellent insights into the way in which customs administrations are seeking to address current and future challenges (Widdowson, 2008b).

Many papers presented at the annual PICARD conferences have been published in the *WCJ* after undergoing a rigorous peer-review process, and PICARD presenters are still encouraged to submit their papers for consideration to the *WCJ*. Through PICARD, the INCU has been focusing its research efforts on areas of specific relevance and importance to the WCO and customs administrations. A number of *WCJ* editions have focused on specific themes that are of particular importance to the WCO and the customs community including capacity building, trade facilitation, supply chain security, integrity, the impact of the Global Financial Crisis, and other topics. For example, the September 2019 edition of the *WCJ* included a section specifically dedicated to papers on data analytics based on a series of innovative WCO workshops on this topic (see for example Widdowson, 2019).

Widdowson (2015b, pp. 218–220) noted that applied research activities and projects have proven extremely valuable in informing strategic customs decision-making and provided examples of how academic research has a practical impact on customs decision-making. In particular, he describes how a masters student in customs wrote a dissertation that was subsequently published in the *WCJ* (see Hesketh, 2010), ultimately forming a key element of the work of the European Union’s CASSANDRA (Common Assessment and Analysis of Risk in Global Supply Chains) Framework Program 7 project which was seeking to make container security more efficient and effective (Widdowson, 2015b).<sup>7</sup>

Widdowson (2015b) also discussed a research project undertaken by CCES on how to improve the competitiveness of Australian international traders through the introduction of an



‘Accredited Operator’-type of program in Australia. That research project was a major catalyst in the introduction of the Australian Trusted Trader program by the Australian Government in 2015 (see Charles Sturt University, 2020).

#### **4.4 PICARD Advisory Group**

The PAG is the central link for cooperation between the WCO and academia in the context of PICARD and it has served and continues to serve as a main mechanism for coordination of PICARD-related matters and activities. As the name suggest, the PAG has an advisory role, but over the years it has been instrumental in guiding the WCO PICARD agenda.

Since its establishment, the PAG has been meeting regularly to, among other things, discuss matters relating to the PICARD program’s development and planning of the PICARD conferences. The PAG also monitors and advises the WCO on relevant academic developments including customs programs and research projects. The PAG played a key role in reviewing and updating the WCO Professional Standards and WCO recognition guidelines and developing the PICARD 2020 and 2030 Strategic Documents. The PAG has also played an important role in the development of the WCO Framework of Principles and Practices on Customs Professionalism and provided support to the WCO in relation to its other activities such as career development in Customs.

#### **4.5 Professional Standards**

The WCO Professional Standards have become the cornerstone initiative of the PICARD program. The standards have been instrumental in recognising Customs as a profession, which has never been done before at an international level, and recognised Customs as a legitimate area of academic pursuit (Widdowson, 2015b). The creation of the Professional Standards has enabled academic institutions to introduce internationally agreed standards into their customs curricula (WCO, 2008b). For the first time there was a clearly defined pathway to education in customs matters at bachelor and master’s levels. These standards are now being used by universities around the world to develop new educational customs programs and to upgrade their existing programs to comply with international standards for academic qualifications for customs professionals from both the public and private sectors and thereby to raise the academic profile of the customs profession (Widdowson, 2015b). Over the years, several new academic institutions and research centres have emerged, actively pursuing training and education of customs officials and/or customs-related research and development functions.

The Professional Standards have also been used as a basis or a reference resource to support other WCO capacity building programs and activities such as the Leadership and Management Development Program (LMDP), People Development and the Framework of Principles and Practices on Customs Professionalism (WCO, 2010a; see also WCO, 2015). For example, the LMDP workshop has an entire module dedicated to strategic management and the Professional Standards (see WCO, 2012). As noted by the WCO (2019a), these standards have been widely disseminated and have guided modernisation efforts of customs administrations based on an ‘investing in people’ approach.

#### **4.6 Recognition of university curricula**

Clearly, prior to the introduction of the Professional Standards and related WCO recognition process, there were no internationally recognised customs university programs and international benchmarks for academic programs in Customs. The first academic programs were formally recognised by the WCO on 26 January 2010 at a ceremony at the WCO headquarters in Brussels, which was ‘a clear endorsement of the commitment shown by the universities over a period of many years to raise the academic standing

## International Network of Customs Universities

of the customs profession' (Widdowson, 2010, p. v). Since then, a number of academic institutions have applied for and attained WCO recognition of their educational programs. As of August 2020, twenty-five university programs (see Table 4) have been formally recognised by the WCO as meeting the Professional Standards.

*Table 4: WCO-recognised academic programs 2010–2020*

<b>Program/course name</b>	<b>Institution/university name</b>	<b>Country</b>	<b>Recognition date</b>
Graduate Certificate in International Customs Law and Administration	Centre for Customs & Excise Studies	Australia	January 2010
Graduate Certificate in Excise Studies	Centre for Customs & Excise Studies	Australia	January 2010
Graduate Diploma in International Customs Law and Administration	Centre for Customs & Excise Studies	Australia	January 2010
Graduate Diploma in Excise Studies	Centre for Customs & Excise Studies	Australia	January 2010
Master of Customs Administration	Centre for Customs & Excise Studies	Australia	January 2010
Master of International Customs Law and Administration	Centre for Customs & Excise Studies	Australia	January 2010
Master of Customs Administration, Law and Policy	University of Muenster	Germany	January 2010
Professional Bachelor program: Administration of Customs and Taxes	Riga Technical University	Latvia	January 2010
Professional Master program: Administration of Customs and Taxes	Riga Technical University	Latvia	January 2010
Baccalaureate in Customs Administration and Foreign Trade	University of Costa Rica	Costa Rica	November 2010
Licentiate in Customs Administration and Foreign Trade	University of Costa Rica	Costa Rica	November 2010
Master in Customs Administration and International Trade	University of Costa Rica	Costa Rica	November 2010
Graduate Diploma in Customs Administration	International Business and Law Institute, ITMO University	Russia	November 2010
Master of Foreign Economic Activity (Customs Field)	International Business and Law Institute, ITMO University	Russia	November 2010
Master of Business Administration (Customs Management)	East and Southern African Management Institute	Tanzania	March 2014
Bachelor of Border Management	Centre for Customs & Excise Studies, Charles Sturt University	Australia	July 2015
Master of Customs Administration	Centre for Customs & Excise Studies, Charles Sturt University	Australia	July 2015

Foreign Trade and Customs Expert	International School of Foreign Trade	Uruguay	July 2015
Specialist in Customs Affairs	North-Western Institute of Management, Russian Presidential Academy of National Economy and Public Administration	Russia	April 2016
Specialist in Customs Affairs	Russian Customs Academy	Russia	June 2018
Bachelor of Customs Administration	Shanghai Customs College	China	May 2018
Executive Master in Customs and Supply Chain Compliance	Rotterdam School of Management, Erasmus University	Netherlands	March 2019
Specialist in Customs Affairs	Al-Farabi Kazakh National University	Kazakhstan	March 2019
Specialist in Customs Affairs	Institute of Law and National Security, Russian Presidential Academy of National Economy and Public Administration	Russia	March 2020
Specialist in Customs Affairs	Samara State Technical University	Russia	March 2020

*Source:* authors, based on INCU (2020a).

WCO recognition has further promoted the importance placed on higher education and academic qualifications for customs managers. In turn, this has encouraged more competition among academic institutions to offer high-quality academic curricula, and the recognition by the WCO can be used by institutions to further assure the quality of their programs and services.

#### 4.7 WCO-INCU MOU

The WCO and INCU have established a very open and productive working relationship since the start of PICARD, helping to support the objectives and members of both organisations. The activities mentioned in the MOU such as permitting reference to the professional association between each other in public documents and providing observer status at each other's annual meetings, are now well established and the MOU has formalised the relationship between the WCO and INCU as a long-term strategic alliance (INCU & WCO, 2009; INCU & WCO, 2012).

Since the signing of the MOU, the WCO and INCU have worked closely together in the PICARD program and they continue to explore opportunities to cooperate in various areas of interest to both organisations. The representatives of both organisations participate in each other's official meetings and events such as the WCO Capacity Building Committee, WCO Council meetings and the INCU annual general meetings, in order to stay apprised of each other's developments, activities and plans.

#### 4.8 PICARD Strategic Document

As discussed earlier, the PICARD Strategic Document outlines the vision, strategy and key elements necessary to enhance the PICARD program (WCO, 2013; WCO, 2020a). According to the WCO (2013), to successfully implement the strategies outlined in the PICARD Strategic Document, strong cooperation between all PICARD stakeholders is the key and this has been occurring.

In addition to the PICARD instruments and initiatives discussed above, the WCO and INCU have worked collaboratively on other capacity building initiatives and programs such as the WCO's Columbus program, WCO E-Learning program, the WCO framework for customs professionalism (see WCO, 2015), career path development, and LMDP. The LMDP contains a common syllabus designed for Customs managers, based on the core components of the Professional Standards and there is a training module in the LMDP workshop that is focused on PICARD and Professional Standards (WCO, 2010b). The WCO (2013, p. 4) further noted that as it continues to roll out the LMDP, 'academic partners will continue to be involved in its delivery as well as in the potential acknowledgement of the programme as pre-learning to studies at their universities.'

Another major outcome and achievement of the PICARD program and the PICARD instruments outlined above is that they have significantly improved customs-academia dialogue and coordination as well as promoted and generated multilateral cooperation among all PICARD stakeholders and have spawned a multitude of other cooperative projects and activities which are difficult to quantify in this paper. These include a range of activities and projects relating to customs to academia, customs to customs, academia to academia, customs to private sector, and academia to private sector cooperation. Accordingly, there is now more multilateral cooperation among various PICARD stakeholders resulting from the introduction and roll out of these PICARD instruments.

### **4.9 PICARD Scientific Board**

The PSB was established and commenced its operation in 2015, and since then it has played an active role in the peer review and selection of papers and presentations for PICARD conferences. To date the PSB has assisted the WCO with paper selections for six PICARD conferences and has reviewed over 250 papers and paper proposals. The PSB's contribution to this process has helped to ensure the quality and relevance of presentations and discussions at the PICARD conferences.<sup>8</sup> Besides helping to ensure the quality and relevance of conference content and research results presented at the conference, the PSB has provided assistance with chairing PICARD conference panels and leading the discussions during the conference including, to some extent, assistance during the PICARD Youth Forum.

## **5. PICARD future directions**

Having summarised PICARD instruments and their objectives, and having discussed the achievements and outcomes of these PICARD instruments and the PICARD program as a whole, this section will focus on the future directions of PICARD and will highlight areas where further improvements can be made.

### **5.1 General observations**

The PICARD program has seen a rapid expansion, especially in the early years since its introduction and has evolved over time to respond to the changing environment facing Customs in the 21st century (WCO, 2010b). According to the WCO (2013), since the PICARD program's beginning, it has enjoyed a sound and productive partnership with academic institutions, which aims to create a cooperative framework, where customs administrations, customs practitioners and academic partners can work together and contribute to advance customs professionalism and customs-related research.

Looking at the objectives of the PICARD instruments and their respective resulting outcomes and achievements discussed above, it is apparent that the INCU network has been actively working to fulfil its objectives and to promote the academic standing of the customs profession, and as envisaged by Fonseca (2008), the INCU has proved to be an effective instrument for customs capacity building. While the cooperation between INCU and WCO under the MOU has been positive and satisfactory progress has been made, there is scope to do more and take this cooperation to the next level.

The benefits of the *WCJ*, which is published by the INCU, are twofold. First, it provides a platform through which research results are reported and disseminated; and second, it serves as a valuable reference resource for customs practitioners, academics, students, and other researchers as well as for the broader international community. In this regard, it is considered that the *WCJ* has firmly achieved its stated objectives. As a result of PICARD, there has been an emergence of other international and national academic journals on customs aspects, for example, the *Customs Scientific Journal (CSJ)*, which was first launched in April 2011 and has established itself as a reputable academic journal in which many academics who are active in PICARD publish their papers (see Kashubsky et al., 2016).

Looking at the PAG's role and purpose, it can be concluded that not only did it meet its objectives, but exceeded them, and it continues to play an important role in cooperation between the WCO and academia. Similarly, the PSB, established in 2015, has served its purpose well in that it has provided important support to the WCO with respect to PICARD conference paper selections, ensuring their quality and relevance, and to some extent provided assistance with chairing conference panels and leading the discussions during the conference.

As outlined above, the WCO Professional Standards and related WCO recognition process are probably the most significant instruments of PICARD. Not only have the Professional Standards been the central feature of the PICARD program and helped to establish and recognise Customs as a profession, they have also been widely disseminated and have guided modernisation efforts of customs administrations, as well as being used to support other WCO capacity building activities and programs (see WCO, 2010a; WCO, 2015). As a result of introducing the WCO recognition process to PICARD, customs administrations now have more options of WCO-recognised academic programs where they could potentially enrol their officers. Furthermore, WCO recognition is, in effect, a quality assurance process for academic programs in Customs, which ensures that the quality and content of the programs adheres to the Professional Standards. Looking at the list of academic programs that had been formally recognised by the WCO (see Table 4), it can be concluded that these PICARD instruments have truly achieved their stated aims and objectives.

Considering the PICARD developments and activities that took place since the adoption of the PICARD 2020 Strategic Document in 2013, while efforts aimed at achieving the vision and aims of the PICARD strategy have continued, two noticeable outcomes or outputs resulting from the implementation of the PICARD Strategic Document have been the review and adoption of the revised Professional Standards and associated curriculum recognition procedures and guidelines, and the development of the revised PICARD strategy in the form of the PICARD 2030 Strategic Document.

However, the PICARD cooperative partnership is not without shortcomings and there is scope for improvement and enhancement on a couple of PICARD fronts. Much has been achieved, but there is still much to be done. Widdowson (2011a) has pointed out that this unique customs-academia partnership under PICARD can be better utilised for the benefit of all stakeholders.

## **5.2 Meaningful research themes and topics**

PICARD provides good opportunities for matchmaking between customs administrations (that is, research demand) and academia (that is, research supply). As Hintsä (2012) noted in his key witness report at the 7th PICARD conference in Morocco, 'one should systematically collect and analyse research needs from customs administrations and share them with the academic community'. Similarly, Widdowson (2011a)

highlighted the need to ensure that academic research remains demand-driven rather than supply-driven, otherwise it will not be valued, or it will not even be read by those who could potentially benefit from it. Although this has been done in PICARD, at least to some extent, since 2012, it would be beneficial to continue developing and implementing such matchmaking schemes to the maximum extent possible, in order to facilitate production of customs research with high practical relevance. Of course, one should not underestimate the potential difficulties relating to the sensitive nature of customs information and data and the multidisciplinary nature and high dynamics of the customs field (see Hintsä, 2006), but with joint efforts and some good will on the part of all key stakeholders (that is, the WCO, customs administrations and academia), the relevant challenges can be overcome.

Alongside a continuous process where real knowledge gaps articulated by customs experts play a key role in defining PICARD research themes and topics, researchers should explore options to exploit a variety of WCO groups, meetings and events for both collection of research data and dissemination of research outcomes. For example, the multi-year ‘AEO benefits’ research led by CBRA (see for example Hintsä et al., 2016) strongly benefited from survey data collected at the WCO Global AEO Conferences (years 2014, 2016 and 2018). Another example relates to dissemination of research outcomes. When going back to the first two years of PICARD, the key findings of the WCO-mandated study on ‘The 21st Century Supply Chain Model’ (Hintsä et al., 2007) were presented at the WCO Council Meeting in June 2007, feeding directly into broader WCO activity on ‘Customs in the 21st Century’ (see WCO, 2008d). Many opportunities and potential synergies lie in front of us, in the context of PICARD research and proactive collaboration between academics and customs practitioners.

Regarding several customs research themes and topics of fundamental importance, topped with a high degree of complexity and dynamics, one should consider repeating them at regular intervals in PICARD conferences and related Calls for Papers. One example from the past is the fast-evolving and complex topic of customs risk management, with the following three illustrative milestones, the earlier ones feeding into later ones:<sup>9</sup> (i) risk management was first identified as a high priority research topic during the 1st PICARD conference in 2006 (Hintsä, 2006); (ii) the results of the WCO-mandated study to explore risk priority, technical and organisational issues in customs risk management were published in 2010 (Hintsä and Männistö, 2010; Hintsä et al., 2010); and (iii) European Union Horizon 2020 project ‘PROFILE: Enhancing Customs Risk Management with Big Data and Data Analytics’ was launched in 2018, with five WCO member administrations as end user partners (Männistö et al., 2019; Männistö and Hintsä, 2019). Regarding the future of PICARD, it is highly recommended to construct continuity regarding high priority customs research themes and topics.

Open Innovation remains to a large extent an underexplored opportunity in the world of Customs. In the future, PICARD could play a key role in scoping, publishing and organising calls for open innovation activities, such as challenge competitions, hackathons or crowdsourcing ideas. The European Union Horizon 2020 project Pan-European Network of Customs Practitioners (PEN-CP) (see for example Hintsä, 2019; Francis et al., 2019; Hintsä et al., 2018b) provides a practical example of a network where multiple customs administrations jointly identify needs and priorities for future innovations, which with help from academic partners are converted into conference themes as per the relevant Calls for Proposals, as well as similar announcements, covering a variety of innovation instruments.<sup>10</sup> The first tangible step in this direction could take place, for example, in the form of a PEN-CP-PICARD co-organised ‘Customs Innovation Award’ competition, from 2020 onwards.

Ultimately, PICARD can provide a unique platform for identifying high priority customs research topics; enabling access to research data; publishing and disseminating the research outcomes; and even reporting back whether administrations have benefited from the results, in a ‘feedback-loop and continuous improvement’ style (Hintsä, 2012).

### 5.3 Balancing research and professionalism pillars

Another area of improvement relates to the PICARD conferences and implementation of the PICARD strategy, but it impacts the entire PICARD program. The first issue is that since 2014, the WCO has stopped producing the reports of the PICARD conferences. Accordingly, apart from short news items published by the WCO after the conclusion of each PICARD conference, which only briefly summarise conference highlights and key outcomes, there are no official records documenting the discussions that transpire at the PICARD conferences. This oversight can be easily corrected by the WCO by publishing the PICARD conference reports again, possibly beginning with the 2020 PICARD conference.

In the past, the annual PICARD conferences were jointly organised by the WCO, the INCU and the host academic institutions and/or customs administrations. However, since 2014, there appears to be little academic involvement in organising the PICARD conferences and the PAG's role in planning the PICARD conferences appears to have been replaced with the PSB's involvement in reviewing conference papers. Furthermore, in recent years the PICARD conference has become almost exclusively focused on research, presentation of research papers and reporting of research results. Relatively little attention and time is devoted to discussions and work relating to the professionalism pillar of the PICARD program, and to the implementation of the PICARD Strategic Document relating to customs professionalism. This impacts the entire PICARD program because the balance of interest and priorities appears to have largely shifted towards research, while more attention could be given to professionalism.

To ensure the continued success of such PICARD initiatives and instruments, Widdowson (2015b, p. 221), emphasises the importance of maintaining ongoing collaboration and a partnership approach between the key players and 'working together to find practical solutions based on sound information and empirical evidence'. Therefore, the WCO could consider achieving a more equal balance between promoting research and promoting professionalism. The WCO can also place more effort into implementing 'professionalism' aspects of the PICARD Strategic Document. This may be done relatively easily by giving more significance to topics that address the implementation of the PICARD Strategic Document and by allocating adequate conference time to those topics. This would provide participants with an opportunity to debate those matters at the PICARD conferences and to help the PICARD conference regain its initial status as the PICARD instrument that guides the policy of the WCO on its engagement in the field of education and academic research. It would also help to pave the way for future directions for the PICARD program and to continue to develop new cooperative frameworks and structures as well new PICARD instruments for further advancement of PICARD.

In progressing further the implementation of the PICARD Strategic Document, the WCO could play a more active role in facilitating and encouraging various cooperative arrangements between PICARD stakeholders. While it is stated in the PICARD Strategic Document that customs administrations should enter into cooperative partnerships with their national academic institutions, the WCO could be more active in boosting and facilitating such collaborations among its members and local academic institutions and in encouraging national governments to place more significance on partnerships between Customs and academia.

## 6. Conclusion

From its inception in 2006, the PICARD program has come a long way. It developed rapidly and has remained a major dynamic capacity building program of the WCO. In short, it can be said that

the program has been a success. The success of the PICARD program is a testament to the strong backing of the WCO leadership including former and present WCO Secretaries-General who have been supporters of PICARD from the start. The way the WCO has approached its partnership with academia is commendable and should serve as a good example for other international organisations that are developing cooperation and partnerships with academia.

While adequate progress has been made to date, there is scope for further improvement by all key players and stakeholders as well as scope to do and achieve more, and together to advance this customs-academia partnership. The PICARD instruments that have been put in place and discussed in this paper should remain key tools of the program and should be further promoted and utilised by all stakeholders.

As for the question of whether PICARD has met stakeholders' expectations, that question cannot be answered in this paper with certainty because the views of all stakeholders would need to be considered. However, in broad terms, it is considered that significant progress and a number of important achievements have been made for the benefit of both Customs and academia. It further can be concluded that the PICARD program and its key instruments have met their stated and intended objectives.

## References

- Azevêdo, R. (2015). Opening Address. In *Proceedings of the Inaugural INCU Global Conference 'Trade Facilitation Post-Bali: Putting Policy into Practice'* (p. 31). Canberra: International Network of Customs Universities.
- Charles Sturt University (2020). *Research Impact: Enhancing the competitiveness of Australia's international traders*. Retrieved from [https://cdn.csu.edu.au/\\_\\_data/assets/pdf\\_file/0004/3496135/Competitiveness-of-Aus-Traders-v.2.pdf](https://cdn.csu.edu.au/__data/assets/pdf_file/0004/3496135/Competitiveness-of-Aus-Traders-v.2.pdf)
- Cross-Border Research Association (CBRA) (2018). *About PEN-CP*. Retrieved from <https://www.pen-cp.net/>
- Danet, M. (2007). Foreword. *World Customs Journal*, 1(1), p. v.
- Fonseca, J. (2008). The INCU as a tool for capacity building. *World Customs Journal*, 2(2), pp. 11–28.
- Francis T., Hintsä J., Rätsep J., Wong Chan S., Hameri A.-P., & Männistö T. (2019). Developing a Cooperation Framework and an Action Plan for Joint Customs-Police Activities in Research-Innovation-Education, in the context of two Multi-year pan-European Security Practitioner Innovation Promotion and Networking Projects. Paper presented at the *14th WCO PICARD Conference*, Skopje, North Macedonia.
- Hesketh, D. (2010). Weaknesses in the supply chain: Who packed the box? *World Customs Journal*, 4(2), pp. 3–20.
- Hintsä J. (2006). Future Research Agenda for Supply Chain Security, Border Security and Port Security Management. Paper presented at the *1st WCO PICARD Conference*, Brussels, Belgium.
- Hintsä, J., Abu Ayyash, F., Hameri, A.P., Myers, P., Coulibaly, N., & Gutierrez, X. (2007, June). The 21st Century Supply Chain Model. Presentation at the *WCO Council Sessions*, Brussels, Belgium.
- Hintsä J. (2008). FP6-INTEGRITY: China to EU Secure and Efficient Tradeline Research Project. Presentation at the *3rd WCO PICARD Conference*, Shanghai, China.
- Hintsä, J., & Männistö, T. (2010). Initial results of the Custom risk management survey. *WCO News* 62, pp. 17–19.
- Hintsä, J., Männistö, T., Hameri, A.P., Finger, M., Thibedeau, C., Sahlstedt, J., & Tsikolenko, V. (2010). Customs risk management (CRiM): a survey with 24 customs administrations. In *Proceedings of the 3rd International Conference on Transportation and Logistics (T-LOG)*, 6–8 September, Fukuoka City, Japan.



- Hintsä J. (2012). Key Witness Speech. *7th WCO PICARD Conference*, Marrakech, Morocco.
- Hintsä J., & Uronen, K. (eds.) (2012). *FP7-CASSANDRA: Common assessment and analysis of risk in global supply chains*. Compendium of FP7-project CASSANDRA.
- Hintsä J. (2014). AEO programmes, the benefits for supply chain companies and MRA preparations. *WCO News 74*, pp. 42–46.
- Hintsä J., Mohanty, S., Rudzitis, N., Fossen, C., & Heijmann, F. (2014). The role and value of customs administrations in minimization of socio-economic negative impacts related to illicit import flows in freight logistics systems – three preliminary cases in Europe – FP7-CORE. Paper presented at the *9th WCO PICARD Conference*, Puebla, Mexico.
- Hintsä J., Wong, S., Rudzitis, N., Phan, H., Mommen, B., Hameri, AP., Heijmann, F., & Männistö T. (2015). Feasibility Study on a Global Customs Revenue Benchmarking Database. Paper presented at the *10th WCO PICARD Conference*, Baku, Azerbaijan.
- Hintsä J., Urciuoli L., & Tan Y. (2016). Authorized Economic Operator (AEO) Benefits and Trusted Trade Lanes. Panel Discussion at the *11th WCO PICARD Conference*, Manila, Philippines.
- Hintsä J., & Männistö, T. (2017). Measuring Trade Facilitation and Border Management Performance. Panel Discussion at the *12th WCO PICARD Conference*, Hammamet, Tunisia.
- Hintsä J., & Mohanty S. (2017). Cost Measurement in Customs Administrations – What Can Be Measured, How, on What Cost, and with Which Benefits. Panel Discussion at the *12th WCO PICARD Conference*, Hammamet, Tunisia.
- Hintsä J., Männistö, T., & Wong Chan S. (2018a). *FP7-CORE: Supply chain security and trade facilitation educational materials*. Deliverable D19.1 and Canvas Learning Management System, FP7-project CORE.
- Hintsä J., Wong Chan S., Grainger A., & Czyżowicz W. (2018b). Customs-Academia Collaborative Research-Development-Innovation (RDI) Projects: Case European Union Framework Program – How Can WCO Members Derive Tangible Benefits? Panel discussion at the *13th WCO PICARD Conference*, Malatya, Turkey.
- Hintsä J. (2019). The PEN-CP project boosts innovation and connects people knowledgeable in Customs and border security. *WCO News 88*. Retrieved from <https://mag.wcoomd.org/magazine/wco-news-88/the-pen-cp-project/>
- International Network of Customs Universities (INCUI) (2007). *Introducing INCUI* [Brochure]. Canberra.
- International Network of Customs Universities (INCUI) (2014). *International Network of Customs Universities Incorporated Constitution*. Canberra. Retrieved from <https://incu.org/wp-content/uploads/2018/08/INCUI-Constitution-May-2014.pdf>
- International Network of Customs Universities (INCUI) (2020a). *Accredited Programs*. Retrieved from <https://incu.org/resources/picard/accredited-programs/>
- International Network of Customs Universities (INCUI) (2020b). Baku Regional Office. Retrieved from <https://incu.org/about/incui-regional-offices/baku-azerbaijan/>
- International Network of Customs Universities (INCUI) (2020c). *Conference and Event Materials*. Retrieved from <https://incu.org/resources/conference-materials/>
- International Network of Customs Universities (INCUI) (2020d). *Directory: All Membership Categories*. Retrieved from <https://incu.org/directory/>
- International Network of Customs Universities (INCUI) (2020e). *Governance and Structure*. Retrieved from <https://incu.org/about/governance-arrangements/>
- International Network of Customs Universities (INCUI) (2020f). *World Customs Journal Publishing Details*. Retrieved from <https://worldcustomsjournal.org/publishing-details/>

- International Network of Customs Universities and World Customs Organization (INCU & WCO) (2009). *Memorandum of Understanding between the World Customs Organization (WCO) and the International Network of Customs Universities Inc (INCU)*, 25 September 2009.
- International Network of Customs Universities and World Customs Organization (INCU & WCO) (2012). *Memorandum of Understanding between the World Customs Organization (WCO) and the International Network of Customs Universities Inc (INCU)*, 25 September 2012.
- Ireland, R. (2015). Email to the PSB, 5 June 2015, Brussels.
- Karlsson, L. (2008). Letter to the INCU, 17 March 2008, Brussels.
- Kashubsky, M., Pavlenko, O., & Chentsov, V. (2016). Customs Scientific Journal: recent developments and future plans. *World Customs Journal*, 10(1), pp. 135–137.
- Mikuriya, K. (2007). Foreword. *World Customs Journal*, 1(2), p. v.
- Männistö, T., & Hintsu, J. (2019). PROFILE: Enhancing Customs Risk Management. *WCO News 89*. Retrieved from <https://mag.wcoomd.org/magazine/wco-news-89/profile-enhancing-customs-risk-management/>
- Männistö T., Hintsu J., Migeotte J., Molenhuis M., Alpstedt A., Wong Chan S., & Hameri A-P. (2019). PROFILE Project: Enhancing Customs Risk Management with Big Data and Data Analytics. Paper presented at the *14th WCO PICARD Conference*, Skopje, North Macedonia.
- PEN-CP – H2020-project – Pan-European Network of Customs Practitioners (PEN-CP) (2018). *About PEN-CP*. Retrieved from <https://www.pen-cp.net/>
- PROFILE – H2020-project – Innovative Data Analytics, Data Sources and Architecture for European Customs Risk Management (PROFILE) (2018). *About PROFILE*. Retrieved from <https://www.profile-project.eu/about-profil>
- Widdowson, D. (2008a). Editorial. *World Customs Journal*, 2(1), p. v.
- Widdowson, D. (2008b). Editorial. *World Customs Journal*, 2(2), p. v.
- Widdowson, D. (2008c). Letter to the WCO. 22 May 2008, Canberra.
- Widdowson, D. (2009) Editorial. *World Customs Journal*, 3(2), p. vii.
- Widdowson, D. (2010). Editorial. *World Customs Journal*, 4(1), p. v.
- Widdowson, D. (2011a). Editorial. *World Customs Journal*, 5(2), p. v.
- Widdowson, D. (2011b). Letter to the WCO. 17 May 2011, Canberra.
- Widdowson, D. (2015a). Editorial. *World Customs Journal*, 9(2), p. v.
- Widdowson, D. (2015b). The role of Customs scholarship in capacity building. In *Studies on harmonization of customs law and contributions of the academy for updating and improving the WCO*. Brussels: International Customs Law Academy, pp. 207–222.
- Widdowson, D. (2019). Editorial. *World Customs Journal*, 13(2), p. iii.
- Widdowson, D., Blegen, B., Kashubsky, M., & Grainger, A. (2014). *Review of Accredited Operator Schemes*. CCES Research Paper Series, Canberra: Centre for Customs and Excise Studies.
- Widdowson, D., Blegen, B., Short, G., & Kashubsky, M. (2017). *Review of Australia's National Committee on Trade Facilitation*, CCES Research Paper Series, Canberra: Centre for Customs and Excise Studies.
- Widdowson, D., Blegen, B., Short, G., Lewis, G., Garcia-Godos, E., Kashubsky, M., Baker, H., & Juratowitch, B. (2018). *Review of Australia's progress towards implementation of the Single Window concept*, CCES Research Paper Series, Canberra: Centre for Customs and Excise Studies.
- World Customs Organization (WCO) (2005a). *Note of Meeting on Co-operation between WCO, Universities and Research Establishments*. 17 November 2005, Brussels: WCO.

- World Customs Organization (WCO) (2005b). *Report of the Meeting between the WCO and Representatives of Universities and Research Institutes*. 11 May 2005, Brussels: WCO.
- World Customs Organization (WCO) (2006). *Report of the Conference on Partnership in Customs Academic Research and Development*. Brussels: WCO.
- World Customs Organization (WCO) (2007). *WCO PICARD Conference 2007*. Brussels: WCO.
- World Customs Organization (WCO) (2008a). Letter to David Widdowson. 17 March 2008, Brussels: WCO.
- World Customs Organization (WCO) (2008b). *Professional Standards*. Brussels: WCO.
- World Customs Organization (WCO) (2008c). *WCO PICARD Conference 2008*. Brussels: WCO.
- World Customs Organization (WCO) (2008d). *Customs in the 21st Century: Enhancing Growth and Development through Trade Facilitation and Border Security*. Brussels: WCO.
- World Customs Organization (WCO) (2009). Guidelines on WCO Recognition of University Customs Curricula. *World Customs Journal*, 3(2), pp. 142–151.
- World Customs Organization (WCO) (2010a). *Report of the Capacity Building Committee*. 1st Session. 22 November 2010. Brussels: WCO.
- World Customs Organization (WCO) (2010b). WCO has a new Committee for Capacity Building! *World Customs Journal*, 4(2), pp. 107–108.
- World Customs Organization (WCO) (2012). *World Customs Organization Leadership and Management Development Workshop*. Brussels: WCO.
- World Customs Organization (WCO) (2013). *A Strategic Roadmap for the PICARD Programme in 2020*. Brussels: WCO.
- World Customs Organization (WCO) (2014). PICARD Advisory Group Minutes of Meeting. 1 April 2014. Brussels: WCO.
- World Customs Organization (WCO) (2015). *WCO Framework of Principles and Practices on Customs Professionalism*. Brussels: WCO.
- World Customs Organization (WCO) (2019a). *PICARD – Professional Standards 2019*. Brussels: WCO.
- World Customs Organization (WCO) (2019b). *WCO Recognition of Customs Curricula Guidelines*. Brussels: WCO.
- World Customs Organization (WCO) (2020a). *A Strategic Roadmap for the PICARD Programme in 2030*. Brussels: WCO.
- World Customs Organization (WCO) (2020b). *Event History*. Retrieved from <http://www.wcoomd.org/en/events/event-history.aspx>
- World Customs Organization (WCO) (2020c). *Report of the Capacity Building Committee*. 11th Session, 21 April 2020. Brussels: WCO.

### Notes

- 1 The complete list of top ten research topics identified in the area of supply chain security, border security and port security management, in priority order: 1) analysing cost of security, 2) identifying efficient security measures and standards, 3) finding the right balance between security and facilitation, 4) identifying benefits of security measures and standards, 5) defining common security standards, 6) developing and testing new security technologies, 7) developing business–customs relationships, 8) risk reduction/prevention, 9) trade policies and 10) security legal systems (see Hints, 2006).
- 2 The members of the first PSB that was formed for the 2015 PICARD were: Iqbal Babayev, State Customs Committee of the Republic of Azerbaijan (Azerbaijan); Emmanuel Brunet-Jailly, Professor, University of Victoria & Editor, *Journal of Borderland Studies* (Canada); Thomas Cantens, Technical Officer, WCO Research Unit & Researcher at the Centre Norbert Elias, School of Higher Studies in Social Sciences; Chang-Ryung Han, Technical Officer, WCO Research Unit; Juha Hints, Director, Cross-border Research Association (Switzerland); Rachel McGauran, Research Analyst, WCO Research Unit; Mick Moore, Professorial Fellow, Institute of Development Studies, University of Sussex & Chief Executive Officer of the International Centre for Tax and Development (United Kingdom); Christine Msemburi, Executive Director, WCO Regional Office for Capacity Building (East and Southern Africa); Cedric Parizot, Researcher, National Center for Scientific Research, Research and Studies Institute of the Arab and Muslim World, University of Aix-Marseille (France) & AntiAtlas; Mariya Polner, Policy Advisor, WCO Enforcement Sub Directorate; Gaël Raballand, Senior Public Sector and Governance Specialist, World Bank; David Widdowson, President, International Network of Customs Universities & Editor-in-Chief, *World Customs Journal* (Australia).
- 3 The four founding INCU institutions were the Centre for Customs and Excise Studies at the University of Canberra (Australia), University of Muenster (Germany), Riga Technical University (Latvia) and Cross-border Research Association (Switzerland).
- 4 For more information see PROFILE (2018).
- 5 For more information see PEN-CP (2018).
- 6 The AEO benefit research outcomes are also shared as an animation on CBRA's YouTube Channel (with over 5000 views as of September 2020). See [https://www.youtube.com/watch?v=XIf-AjgLy\\_U](https://www.youtube.com/watch?v=XIf-AjgLy_U)
- 7 (i) For more information on the CASSANDRA project (see for example Hints and Uronen, 2012); (ii) the Framework Program 6 project INTEGRITY (Intermodal Global Door-to-door Container Supply Chain Visibility, 2008–2011), the predecessor project to CASSANDRA, was presented during the 3rd PICARD conference, in Shanghai Customs College (Hints, 2008); (iii) the Framework Program 7 project CORE (Consistently Optimised Resilient Secure Global Supply-Chains) became an important follow-up project for CASSANDRA; partners including WCO and CBRA (see for example Hints et al., 2018b).
- 8 It should be noted that the WCO Research Unit developed a methodology for the paper selection process which was communicated to members of the PSB at the time, and the key criteria for selecting papers were determined to be: (1) quality of the writing and analytical thinking; and (2) originality of the ideas presented (Ireland, 2015).
- 9 However, naturally, there are numerous other papers on customs risk management presented at the PICARD conferences.
- 10 PEN-CP provides following short definitions on the innovation instruments: (i) prototype grants – co-develop and field test promising technologies with customs practitioners; (ii) challenge competitions – submit your blueprint to solve a specific customs problem, and receive seed funding towards making it a reality; (iii) hackathons – unleash your IT development and programming skills, in an intensive session to design and pilot algorithms and tools for the brighter future of digital customs; (iv) crowdsourcing ideas – submit your out-of-the-box ideas to gain recognition and fame as a forward-thinking customs innovator; (v) innovation awards and prizes – share the outcomes of your innovative customs projects to claim a trophy of excellence; (vi) PEN-tournaments – demonstrate your skills in head-to-head competitions against other experts from the customs community; and (vii) expert reports – produce a consulting report on a specific topic of customs interest (see Pan-European Network of Customs Practitioners, 2020).

**Mikhail Kashubsky**

Dr Mikhail Kashubsky is an Associate Professor and Higher Degrees by Research (HDR) Coordinator at the Centre for Customs and Excise Studies (CCES), Charles Sturt University and Head of Secretariat of the International Network of Customs Universities (INCU). Dr Kashubsky has been an active PICARD contributor since its inception. Dr Kashubsky serves on the Editorial Board of the Customs Scientific Journal (CSJ) and the Advisory Council of the Global Trade Development Week (GTDW). He holds a PhD in law from the Australian National Centre for Ocean Resources and Security (ANCORS), University of Wollongong and he is a barrister and solicitor of the High Court of Australia and the High Court of New Zealand. Dr Kashubsky also holds the title of an Honorary Customs Officer of the Republic of Azerbaijan which he was awarded in 2015 for his contribution to international customs cooperation.

**Juha Hintsa**

Dr Juha Hintsa is the founder and CEO of Cross-border Research Association (CBRA) based in Lausanne, Switzerland and a well-known researcher, lecturer and consultant in supply chain security and global trade facilitation. Dr Hintsa is one of the pioneers of and an active contributor to PICARD. He is one of the founding members of the International Network of Customs Universities (INCU), a member of the PICARD Advisory Group, a member of the PICARD Scientific Board, a member of the Editorial Board of the World Customs Journal (WCJ) and the only person who has participated in all 14 PICARD conferences organised so far. Dr Hintsa holds a PhD in management from HEC University of Lausanne and he has participated in around 30 research-development-innovation projects and is an author of about 70 publications on customs, security and trade-related topics.





## *Section 2*

## *Reference Material*





# Guidelines for Contributors

The *World Customs Journal* invites authors to submit papers that relate to all aspects of customs activity, for example, law, policy, economics, administration, information and communications technologies. The Journal has a multi-dimensional focus on customs issues and the following broad categories should be used as a guide.

## Research and theory

The suggested length for articles about research and theory is approximately 5,000 words per article. Longer items will be accepted, however, publication of items of 10,000 or more words may be spread over more than one issue of the Journal.

Original research and theoretical papers submitted will be reviewed using a ‘double blind’ or ‘masked’ process, that is, the identity of author/s and reviewer/s will not be made known to each other. This process may result in delays in publication, especially where modifications to papers are suggested to the author/s by the reviewer/s. Authors submitting original items that relate to research and theory are asked to include the following details separately from the body of the article:

- title of the paper
- names, positions, organisations, and contact details of each author
- bionotes (no more than 100 words for each author) together with a recent, high resolution, colour photograph for possible publication in the Journal. Please ensure the image is a jpeg with a resolution of 300 dpi.
- an abstract of no more than 100 words for papers up to 5,000 words, or for longer papers, a summary of up to 600 words depending on the length and complexity of the paper.

Please note that previously refereed papers will not be refereed by the *World Customs Journal*.

## Practical applications, including case studies, issues and solutions

These items are generally between 2,000 and 5,000 words per article. Authors of these items are asked to include bionotes (no more than 100 words for each author) together with a recent, high resolution, colour photograph (jpeg with a resolution of 300 dpi) for possible publication in the Journal. The Editorial Board will review articles that relate to practical applications.

## Reviews of books, publications, systems and practices

The suggested length is between 350 and 800 words per review. The Editorial Board will review these items submitted for publication.

## Papers published elsewhere

Authors of papers previously published should provide full citations of the publication/s in which their paper/s appeared. Where appropriate, authors are asked to obtain permission from the previous publishers to re-publish these items in the *World Customs Journal*, which will acknowledge the source/s. Copies of permissions obtained should accompany the article submitted for publication in the *World Customs Journal*.

Authors intending to offer their papers for publication elsewhere—in English and/or another language—are asked to advise the Editor-in-Chief of the names of those publications.

Where necessary and appropriate, and to ensure consistency in style, the editors will make any necessary changes in items submitted and accepted for publication, except where those items have been refereed and published elsewhere. Guidance on the editors’ approach to style and referencing is available on the Journal’s website.

## Letters to the Editor

We invite Letters to the Editor that address items previously published in the Journal as well as topics related to all aspects of customs activity. Authors of letters are asked to include their name and address (or a pseudonym) for publication in the Journal. As well, authors are asked to provide full contact details so that, should the need arise, the Editor-in-Chief can contact them.

All items should be submitted in Microsoft Word or RTF, as email attachments, to the Editor-in-Chief: [editor@worldcustomsjournal.org](mailto:editor@worldcustomsjournal.org)

## Editorial Board

### Professor David Widdowson AM



Charles Sturt University, Australia *Editor-in-Chief*

Professor David Widdowson is Chief Executive Officer of the Centre for Customs and Excise Studies at Charles Sturt University, Australia. He is President of the International Network of Customs Universities, a member of the WCO's PICARD Advisory Group and Scientific Board, and a founding director of the Trusted Trade Alliance. David holds a PhD in Public Sector Management and has over 40 years' experience in international trade regulation, including 21 years with the Australian Customs Service. In 2019 he was appointed as a Member of the Order of Australia for significant service to higher education in the field of international trade and customs.

### Professor Hans-Michael Wolfgang



University of Münster, Germany

Professor Dr Hans-Michael Wolfgang is Professor of International Trade and Tax Law and Head of the Department of Customs and Excise which forms part of the Institute of Tax Law at the University of Münster, Germany. He is director of the Münster Masters studies in Customs, Taxation and International Trade Law and has written extensively on international trade law, customs law and export controls in Europe.

### Dr Andrew Grainger



Trade Facilitation Consulting Ltd, United Kingdom

Dr Andrew Grainger is a trade facilitation practitioner, academic and educator with over 20 years of experience. As the Director of Trade Facilitation Consulting Ltd, he is regularly contracted by government agencies, companies and international organisations around the world. He is also an Honorary Associate Professor at the University of Nottingham and collaborates with other leading universities and research institutes. In previous roles, Andrew was the Deputy Director for Trade Procedures at SITPRO, the UK's former trade facilitation agency, and Secretary for EUROPRO, the umbrella body for European trade facilitation organisations. His PhD thesis in Supply Chain Management and Trade Facilitation was awarded the prestigious Palgrave Macmillan Prize for best PhD in Maritime Economics and Logistics 2005–2008. He has authored many papers within the subject of trade and customs procedures and is a member of the International Network of Customs Universities' (INCUI) executive committee.

### Professor Aydin Aliyev



State Customs Committee, Republic of Azerbaijan

Professor Aydin Aliyev is a Colonel General of Customs Service (Rtd) and former Chairman of the State Customs Committee of the Republic of Azerbaijan. He is a graduate in Law from Azerbaijan State University, and author of educational and scientific articles and books on customs matters which have been published in several countries. His contributions to the development of customs administrations and for strengthening customs cooperation have been recognised by the World Customs Organization, the Federal Customs Service of the Russian Federation, the Republic of Hungary and by customs administrations of several other countries. In 2010, Prof. Aliyev was awarded the title of 'Honoured Lawyer of the Republic of Azerbaijan' by Presidential Decree. In 2014, he was admitted as an Honorary Fellow of the International Network of Customs Universities for his contribution to raising the academic standing of the customs profession.

### Professor Enrique Barreira



BRSV, Buenos Aires, Republic of Argentina

Professor Enrique Barreira is a founding partner of BRSV Attorneys at Law in Buenos Aires, Argentina. He was one of the drafters of the Argentine Customs Code. He has also been a professor of Customs Tax Law, Customs Regimes, and Anti-dumping and Subsidies in the Graduate Program at the School of Law, University of Buenos Aires since 1993, and is a founding member of the International Customs Law Academy. Professor Barreira has been the Argentine arbitrator to the Mercosur in various disputes.

### Dr Juha Hintsa



Cross-border Research Association and Hautes Etudes Commerciales (HEC), University of Lausanne, Switzerland

Dr Juha Hintsa is a Senior Researcher in global supply chain security management. He is one of the founding partners of the Global Customs Research Network, and the founder of the Cross-border Research Association (CBRA) in Lausanne, where he undertakes research into various aspects of supply chain security management in close collaboration with several multinational corporations. Juha's PhD thesis was on 'Post-2001 supply chain security: impacts on the private sector'.

### Dr Santiago Ibáñez Marsilla



Public Finance Law and Taxation Department, University of Valencia.

Dr Santiago Ibáñez Marsilla is Principal Advisor, Spain, for Trusted Trade Alliance. His area of expertise is customs law and he is currently the Jean Monnet Chair, EU Customs Law, which is awarded by the European Commission. In 2017–2018 he was the senior expert at the mid-term evaluation of TAXUD's Customs 2020 program. EuropeAid, USAID and Europäische Rechtsakademie (ERA) are among the institutions that have relied upon his customs law expertise. Santiago is used to working in international environments and has trained, taught or delivered presentations in 23 countries, and has authored more than 60 publications.

## Principal Editors

### Dr Pam Faulks



Charles Sturt University, Australia

Dr Pam Faulks is an editor with the Centre for Customs & Excise Studies (CCES), Charles Sturt University. She is an accredited editor with the Institute of Professional Editors (IPed) and has tertiary qualifications and extensive experience in editing, communications, tourism and education.

### Dr Rebecca Louise Harcourt



Charles Sturt University, Australia

Rebecca is an editor with the Centre for Customs & Excise Studies (CCES), Charles Sturt University. She is an experienced editor, writer and communicator and is a professional member of the Institute of Professional Editors (IPed). Rebecca has worked for many years as a research scientist and as an editor, specialising in the life sciences.